

YU-TT15
AMERICA



THREADING TOOLS

SOLID CARBIDE THREAD MILL / COMBO TAPS / SPIRAL FLUTE TAPS / SPIRAL POINT TAPS /
STRAIGHT FLUTE TAPS / FORMING TAPS / SCREW THREAD INSERT TAPS / PIPE TAPS



www.yg1usa.com

 YG-1 CO., LTD.

GUIDE LINE TO ICONS

Work Material

- MU** Multi-Purpose
- GS** Steels with good machinability
 $R_m < 850 \text{ N/mm}^2$
- HR** High alloyed steels
 $R_m > 1,200 \text{ N/mm}^2$
- VG** Heat treated and heat-resistant steels
 $R_m < 850 \text{ N/mm}^2 \leq R_m \leq 1,200 \text{ N/mm}^2$
- VA** Stainless steels
- GG** Grey Cast Iron
- Al** Aluminum & Aluminum alloys
- GV** Any material with
at least 8~10% elongation
- Ti Ni** Titanium alloys
Nickel alloys

Tool Material

- Carbide** Micrograin carbide
- Super HSS** Premium HSS Metallurgy
- P-HSS** Powder Metallurgy
- HSS-EX** High Vanadium HSS
- HSS-V3** 3% Vanadium Alloy HSS
- HSS-V** Vanadium Alloy HSS
- HSS** High Speed Steel

Standard of Tools

- USCTI 302**
- USCTI 302A**
- USCTI 311**
- USCTI 322**
- USCTI 322A**

Class of Thread

- H1~H11**
- D3~D11**
- 2B**

Thread Angle



Chamfer Lead

- 1.5P~2P**
- 2P~3P**
- 4P~5P**
- 9P/5P/2P**
- 5P~2P**

Surface Treatment

- Bright** Bright Finish
- Steam Oxide** Steam Tempered
- TiCN** Titanium Carbon Nitride Coating
- TiN** Titanium Nitride Coating
- TiAlN** Titanium Aluminum Nitride Coating
- Hardslick** TiAlN+WC/C Coating
- Gold&Black** Titanium Nitride + Steam Tempered

Helix Angle

- R15**
- R40**
- R45**
- R50**
- L15**

CBN End Mill



V7 Mill



X5070 End Mill



D-Power End Mill



Multi-1 Drill



Dream Drill

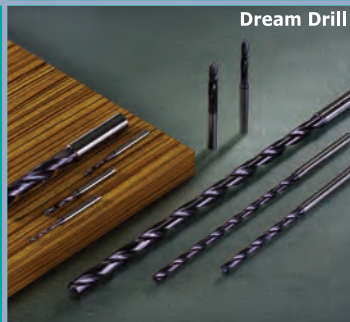

Tank-Power End Mill



HSS End Mill



i-Xmill



i-Dream Drill



Spade Drill Inserts



Combo Tap





THREADING TOOLS



Contents

THREADING TOOLS

Contents / THREADING TOOLS

CARBIDE THREAD MILLS

SOLID CARBIDE THREAD MILL

For blind holes and through holes with one single tool. Higher cutting speed and feed than taps.

SOLID
CARBIDE
THREAD MILLS

COMBOTAPS

Multi Purpose tapping / YG-1's Patent / Super HSS & HSS-E for Prevention of Oversized Threads

COMBO
TAPS

SPIRAL FLUTE TAPS

Tapping Blind Holes / Super HSS, HSS-E, HSS-PM, HSS-V & HSS

SPIRAL
FLUTE TAPS

SPIRAL POINT TAPS

Tapping Through Holes / Super HSS, HSS-E, HSS-PM, HSS-V & HSS

SPIRAL
POINT TAPS

STRAIGHT FLUTE TAPS

Tapping Through & Blind Holes / Carbide, Super HSS & HSS

STRAIGHT
FLUTE TAPS

FORMING TAPS

Tapping by Forming Soft Materials (No Chips)

FORMING
TAPS

SCREW THREAD INSERT TAPS

SCREW
THREAD
INSERT TAPS

PIPE TAPS

Tapping NPT, NPTF, NPS & NPSF threads

PIPE TAPS

TECHNICAL DATA

TECHNICAL DATA

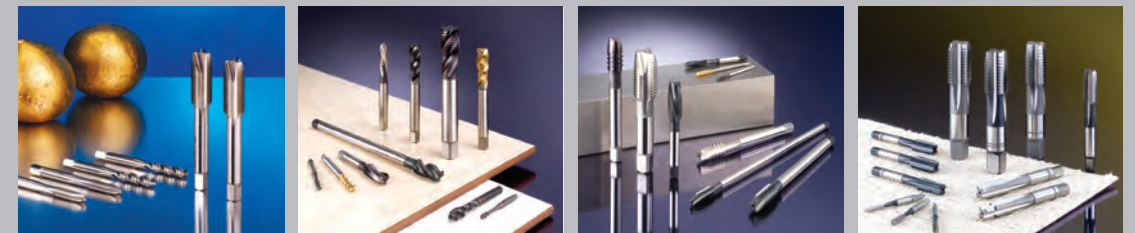

TECHNICAL
DATA



THREADING TOOLS APPLICATION TABLE

















SOLID CARBIDE THREAD MILL

INCH

EDP No.	MODEL	Description	Page
TE		Solid Carbide Thread mill for Unified Internal Threads - ANSI B 1.1	33
TD		Solid Carbide Thread mill for Metric Internal Threads - DIN 13	34
TF TG		Solid Carbide Thread mill for Unified Internal Threads - ANSI B 1.20.1(NPT) / ANSI B1.20.3(NPTF)	35

COMBO TAPS

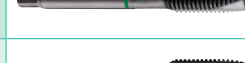
INCH

EDP No.	MODEL	Tool Material	Standard	Work Material	Dimensions	Tolerance	Chamfer	Thread Depth	Surface Treatment	Page
T2 T2-S T2-C		HSS-EX	UNC/UNF	MU	USCTI 302A	H2-H6	2 ~ 3P	2.5D	Bright Steam Oxide TiCN	41
T5 T5-S T5-C		HSS-EX	M	MU	USCTI 302A	D3-D8	2 ~ 3P		Bright Steam Oxide TiCN	43
T6 T6-N	with Internal Coolant 	HSS-EX	UNC/UNF	MU	USCTI 302A	H4-H6	2 ~ 3P		Bright TiN	44
T8 T8-N	with Internal Coolant 	HSS-EX	M	MU	USCTI 302A	D5-D7	2 ~ 3P		Bright TiN	45
T7 T7-C	Short Chamfer 	HSS-EX	UNC/UNF	MU	USCTI 302A	H2-H6	1 ~ 2P		Bright TiCN	46
T9 T9-C	Short Chamfer 	HSS-EX	M	MU	USCTI 302A	D3-D8	1 ~ 2P		Bright TiCN	48
T1-S T1-C		HSS-EX	UNC/UNF	MU	DIN-ANSI Shank	H2-H6	2 ~ 3P		Steam Oxide TiCN	49
TA-S TA-C		HSS-EX	M	MU	DIN-ANSI Shank	D3-D7	2 ~ 3P		Steam Oxide TiCN	50
TCA-S/C TCB-S/C		Super HSS HSS-EX	UNC/UNF	VA	USCTI 302A	H2-H6	2 ~ 3P		Steam Oxide TiCN	51
TCC-S/C TCD-S/C		Super HSS HSS-EX	M	VA	USCTI 302A	D3-D7	2 ~ 3P		Steam Oxide TiCN	53
T4 T4-S T4-C		HSS-EX	UNC/UNF	MU	USCTI 302A	H2-H6	4 ~ 5P	3.0D	Bright Steam Oxide TiCN	54
T3 T3-S T3-C		HSS-EX	M	MU	USCTI 302A	D3-D8	4 ~ 5P		Bright Steam Oxide TiCN	56
TB TB-N	with Internal Coolant 	HSS-EX	UNC/UNF	MU	USCTI 302A	H4-H6	4 ~ 5P		Bright TiN	57
TH TH-N	with Internal Coolant 	HSS-EX	M	MU	USCTI 302A	D5-D7	4 ~ 5P		Bright TiN	58
TC-S TC-C		HSS-EX	UNC/UNF	MU	DIN-ANSI Shank	H2-H6	4 ~ 5P		Steam Oxide TiCN	59
TK-S TK-C		HSS-EX	M	MU	DIN-ANSI Shank	D3-D7	4 ~ 5P		Steam Oxide TiCN	60
TCE-S/C TCF-S/C		Super HSS HSS-EX	UNC/UNF	VA	USCTI 302A	H2-H6	4P		Steam Oxide TiCN	61
TCG-S/C TCH-S/C		Super HSS HSS-EX	M	VA	USCTI 302A	D3-D7	4P		Steam Oxide TiCN	63

THREADING TOOLS APPLICATION TABLE

SPIRAL FLUTE TAPS

INCH









EDP No.	MODEL	Tool Material	Standard	Work Material	Dimensions	Tolerance	Chamfer	Thread Depth	Surface Treatment	Page
BB/BI		Super HSS	UNC/UNF	VG	USCTI 302A	H2~H6	2 ~ 3P	2.5D	Steam Oxide Hardslick	68
BH/BM		Super HSS	M/MF	VG	USCTI 302A	D3~D7	2 ~ 3P		Steam Oxide Hardslick	70
BF/BK		Super HSS	UNC/UNF	VG	DIN-ANSI Shank	H2~H6	2 ~ 3P		Steam Oxide Hardslick	71
BD/BO		Super HSS	M/MF	VG	DIN-ANSI Shank	D3~D7	2 ~ 3P		Steam Oxide Hardslick	72
H5/H7/H8		P-HSS	UNC/UNF	HR	USCTI 302A	H2~H5	2 ~ 3P		Steam Oxide TiCN Hardslick	73
TQ858/TK858/TR858		P-HSS	M/MF	HR	USCTI 302A	H2~H5	2 ~ 3P		Steam Oxide TiCN Hardslick	74
B3/B5/D6		P-HSS	UNC/UNF	Ti Ni	USCTI 302A	H2~H5	2 ~ 3P		Steam Oxide TiCN Hardslick	75
G9/H0		P-HSS	UNC/UNF	VA	DIN-ANSI Shank	H2~H3	2 ~ 3P		Hardslick	77
H2/H4		P-HSS	UNC/UNF	VA	DIN-ANSI Shank	H3	4 ~ 5P		3.0D TiN Hardslick	78
BG/BG-GB		HSSE-V3	UNC/UN8	VG	DIN-ANSI Shank	2B	2 ~ 3P		Hardslick Gold & Black	79
B1/B0/B2/D2		HSSE-V3	UNC/UNF	VA	USCTI 302A	H2~H7	2 ~ 3P	Bright Steam Oxide TiN/Hardslick	80	
BS/BT		HSSE-V3	M/MF	VA	USCTI 302A	D3~D7	2 ~ 3P	Steam Oxide Hardslick	83	
E6/E8/E9		HSSE-V3	M/MF	VA	DIN-ANSI Shank	D3~D7	2 ~ 3P	Steam Oxide TiCN Hardslick	84	
D3/E0		HSSE-V3	UNC/UNF	VG	USCTI 302A	H2~H11	2 ~ 3P	2.5D Hardslick Steam Oxide	85	
BU/BV		HSSE-V3	M/MF	VG	USCTI 302A	D3~D11	2 ~ 3P	Steam Oxide Hardslick	88	
E2/E4/E5		HSSE-V3	M/MF	VG	DIN-ANSI Shank	D3~D7	2 ~ 3P	Steam Oxide TiCN Hardslick	90	
C0/D8		HSSE-V3	UNC/UNF	AI	USCTI 302A	H2~H5	2 ~ 3P	Bright Hardslick	91	
BW/BX		HSSE-V3	M/MF	AI	USCTI 302A	D3~D6	2 ~ 3P	Bright Hardslick	92	

EDP No.	MODEL	Tool Material	Standard	Work Material	Dimensions	Tolerance	Chamfer	Thread Depth	Surface Treatment	Page
C2/C3/C4/D9		HSSE-V3	UNC/UNF	GS	USCTI 302	H2~H6	1.5 ~ 2P	2.5D	Steam Oxide Bright/TiN Hardslick	93
F4/F8/F6		HSS-V	UNC/UNF	GS	USCTI 302A	H2~H6	1.5 ~ 2P		Steam Oxide TiN Hardslick	94
G4/G5/G6		HSS-V	M/MF	GS	USCTI 302A	D3~D6	1.5 ~ 2P		Bright TiCN Hardslick	96
G0/G1/G2		HSS-V	UNC/UNF	GS	DIN-ANSI Shank	H2~H6	2 ~ 3P		Bright TiN Hardslick	97
T7A96/T6A96/T8A96		HSS	UNC/UNF	GS	USCTI 302	H2~H5	4 ~ 5P 1.5 ~ 2P		Bright Steam Oxide TiN	99
T7A86/T6A86/T8A86		HSS	M/MF	GS	USCTI 302	D3~D6	4 ~ 5P 1.5 ~ 2P		Bright Steam Oxide TiN	100
T7A85/T6A85/T8A85		HSS	M/MF	GS	USCTI 302	D3~D6	4 ~ 5P 1.5 ~ 2P		Bright Steam Oxide TiN	100
T7D01/T8D01/T7D02/T8D02		HSS	UNC/UNF	GS	USCTI Long Shank	H3	4 ~ 5P 1.5 ~ 2P		Bright TiN	101

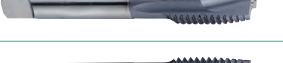
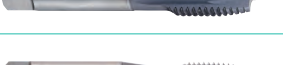
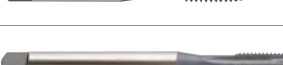
THREADING TOOLS APPLICATION TABLE

SPIRAL POINT TAPS

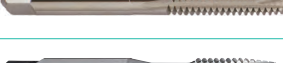
INCH

EDP No.	MODEL	Tool Material	Standard	Work Material	Dimensions	Tolerance	Chamfer	Thread Depth	Surface Treatment	Page
M9/O1		Super HSS	UNC/UNF	VG	USCTI 302A	H2~H6	4 ~ 5P	3.0D	Steam Oxide Hardslick	106
N7/N8		Super HSS	M/MF	VG	USCTI 302A	D3~D7	4 ~ 5P		Steam Oxide Hardslick	108
N4/O5		Super HSS	UNC/UNF	VG	DIN-ANSI Shank	H2~H6	4 ~ 5P		Steam Oxide Hardslick	109
N3/O3		Super HSS	M/MF	VG	DIN-ANSI Shank	D3~D7	4 ~ 5P		Steam Oxide Hardslick	110
M4/M6/M7		P-HSS	UNC/UNF	HR	USCTI 302A	H2~H5	4 ~ 5P		Steam Oxide TiCN Hardslick	111
TQ808/TK808/TR808		P-HSS	M/MF	HR	USCTI 302A	H2~H5	4 ~ 5P		Steam Oxide TiCN Hardslick	112
I3/I5/J6		P-HSS	UNC/UNF	Ti Ni	USCTI 302A	H2~H5	4 ~ 5P		Steam Oxide TiCN Hardslick	113
M2/M3		P-HSS	UNC/UNF	VA	USCTI Long Shank	H2~H3	4 ~ 5P		Hardslick	115
I0/I2/J2		HSSE-V3	UNC/UNF	VA	USCTI 302A	H2~H7	4 ~ 5P		Steam Oxide TiN Hardslick	116
O9/IA		HSSE-V3	M/MF	VA	USCTI 302A	D3~D7	4 ~ 5P		Steam Oxide Hardslick	119
K3/K5/K6		HSSE-V3	M/MF	VA	DIN-ANSI Shank	D3~D7	4 ~ 5P		Steam Oxide TiCN Hardslick	120
J3/J8		HSSE-V3	UNC/UNF	VG	USCTI 302A	H2~H11	4 ~ 5P		Steam Oxide Hardslick	121
IB/IC		HSSE-V3	M/MF	VG	USCTI 302A	D3~D11	4 ~ 5P		Steam Oxide Hardslick	125
J9/K7/K2		HSSE-V3	M/MF	VG	DIN-ANSI Shank	D3~D7	4 ~ 5P		Steam Oxide TiCN Hardslick	127
T2496		HSSE-V3	UNC/UNF	AI	USCTI 302A	H2~H5	4 ~ 5P		Bright	128
T2K01		HSSE-V3	M/MF	AI	USCTI 302A	D3~D6	4 ~ 5P		Bright	129
I9/J0/J1/J7		HSSE-V3	UNC/UNF	GS	USCTI	H2~H6	4 ~ 5P	Steam Oxide Bright/TiN Hardslick	130	
K9/L0/L1		HSS-V	UNC/UNF	GS	USCTI 302A	H2~H6	4 ~ 5P	Bright TiN Hardslick	131	

EDP No.	MODEL	Tool Material	Standard	Work Material	Dimensions	Tolerance	Chamfer	Thread Depth	Surface Treatment	Page
L7/L8/L9		HSS-V	M/MF	GS	USCTI 302A	D3~D6	4 ~ 5P	3.0D	Bright TiCN Hardslick	132
L3/L4/L5		HSS-V	UNC/UNF	GS	DIN-ANSI Shank	H2~H6	4 ~ 5P		Bright TiN Hardslick	133
T7216/T6216/T8216 T7C16/T6C16/T8C16		HSS	UNC/UNF	GS	USCTI 302	H1~H7	4 ~ 5P		Bright Finish Steam Oxide TiN	134
T7256/T6256		HSS	UNC/UNF	GS	USCTI 302	H1~H7	1.5 ~ 2P		Bright Finish Steam Oxide	138
T7217/T6217/T8217		HSS	M/MF	GS	USCTI 302	D3~D7	4 ~ 5P		Bright Finish Steam Oxide TiN	140
T7226/T6226/T8226		HSS	UNC/UNF	GS	USCTI 302	+0.005" oversize	4 ~ 5P		Bright Finish Steam Oxide TiN	141
T7B17/T6B17/T8B17		HSS	M/MF	GS	USCTI 302	+0.127mm oversize	4 ~ 5P		Bright Finish Steam Oxide TiN	142
T7236/T6236/T8236 T7G36/T6G36/T8G36		HSS	UNC/UNF	GS	USCTI Long Shank	H3	4 ~ 5P		Bright Finish Steam Oxide TiN	143

THREADING TOOLS APPLICATION TABLE

STRAIGHT FLUTE TAPS

INCH

EDP No.	MODEL	Tool Material	Standard	Work Material	Dimensions	Tolerance	Chamfer	Thread Depth	Surface Treatment	Page	
T0C01		Carbide	UNC/UNF	GG	USCTI 302A	2B	1.5 ~ 2P	2.0D	Bright	147	
TR		Super HSS	UNC/UNF	GG	USCTI 302A	H3~H5	2 ~ 3P		TiAlN	148	
			M	GG		D4~D6	2 ~ 3P				
TR-A, TR-R		Super HSS	UNC/UNF	GG	USCTI 302A	H3~H5	2 ~ 3P		TiAlN	150	
			M	GG		D4~D6	2 ~ 3P				
T7316/T6316/ T8316/T7A16 T7B16		HSS	UNC/ UNF/ UNS	GS	USCTI 302	H1~H7	9P/5P/2P		3.0D	Bright Steam Oxide TiN	152
T7315/T6315/ T8315		HSS	M/MF	GS	USCTI 302	D3~D9	9P/5P/2P			Bright Steam Oxide TiN	158
T7326		HSS	UNC/UNF	GS	USCTI 302	+0.005" oversize	5P/2P			Bright	159
T7B15		HSS	M/MF	GS	USCTI 302	+0.127mm oversize	5P/2P			Bright	160
T7336		HSS	UNC/UNF	GS	USCTI 302 (Left Hand)	H2~H4	5P/2P			Bright	161
T7A15		HSS	UNC/UNF	GS	USCTI 302 (Left Hand)	D4~D8	5P/2P	Bright		162	
T7616/T6616/ T8616		HSS	UNC/UNF	GS	USCTI Long Shank	H3	4 ~ 5P	Bright Steam Oxide TiN		163	

FORMING TAPS

INCH

EDP No.	MODEL	Tool Material	Standard	Work Material	Dimensions	Tolerance	Chamfer	Thread Depth	Surface Treatment	Page
TKR03		Super HSS	UNC/UNF	GV	USCTI 302A	H3~H7	2 ~ 3P	3.0D	TiCN	167
ZF		HSSE-V3	UNC/UNF	GV	USCTI 302	H2~H5	1.5 ~ 2P		Bright	168
Z0/Z1/Z2/Z3		HSSE-V3	UNC/UNF	GV	USCTI 302A	H2~H12	4 ~ 5P 1.5 ~ 2P		Bright TiN	169
Z4/Z5/Z6/Z7		HSSE-V3	UNC/UNF	GV	USCTI 302A	H3~H12	4 ~ 5P 1.5 ~ 2P		Bright TiN	171
Z8/ZA/ZC Z9/ZB/ZD		HSSE-V3	M/MF	GV	USCTI 302A	D3~D11	4 ~ 5P 1.5 ~ 2P		Bright TiN / TiCN	173
T7R01/T8R01/ THR01 T7R02/T8R02/ THR02		HSS	UNC/UNF	GV	USCTI 302A	H2~H5	4 ~ 5P 1.5 ~ 2P		Bright TiN / TiCN	174

SCREW THREAD INSERT TAPS

INCH

EDP No.	MODEL	Tool Material	Standard	Work Material	Dimensions	Tolerance	Chamfer	Thread Depth	Surface Treatment	Page
ST/SI		HSSE-V3	UNC/UNF	GS	USCTI 322	2B	1.5 ~ 2P	2.5D	Hardslick	177
T7406		HSS	UNC/UNF	GS	USCTI 322	H2~H4	1.5 ~ 2P		Bright	178
T7425		HSS	M/MF	GS	USCTI 322A	D2~D4	1.5 ~ 2P		Bright	179
ST/SI		HSSE-V3	UNC/UNF	GS	USCTI 322	2B	4 ~ 5P	3.0D	Hardslick	180
T7436		HSS	UNC/UNF	GS	USCTI 322	H1~H4	4 ~ 5P		Bright	181
T7415		HSS	M/MF	GS	USCTI 322A	D2~D4	4 ~ 5P		Bright	182
T7426		HSS	UNC/UNF	GS	USCTI 322	H1~H4	4 ~ 5P 1.5 ~ 2P	2.0D	Bright	183
T7405		HSS	M/MF	GS	USCTI 322A	D2~D4	4 ~ 5P 1.5 ~ 2P		Bright	184

PIPE TAPS

INCH

EDP No.	MODEL	Tool Material	Standard	Work Material	Dimensions	Chamfer	Thread Depth	Surface Treatment	Page
Q1/Q0/Q6		HSSE-V3	NPTF	VA	USCTI 311	2 ~ 3P	2.5D	Bright Steam Oxide Hardslick	187
Q9/R0/R1		HSSE-V3	NPTF	GG	USCTI 311	2 ~ 3P		Bright TiN Hardslick	188
R7/R8/R9/S0		HSSE-V3	NPTF	GG	USCTI 311	2 ~ 3P	2.0D	Bright TiN Hardslick Nitrided- Steam Oxide	189
S1/S2		HSSE-V3	NPTF	GG	USCTI 311	2 ~ 3P		Bright TiCN	190
T7L36/T6L36 T7536/T6536		HSS	NPS/NPSF	GS	USCTI 311	4 ~ 5P		Bright Steam Oxide	191
T7505/T6505/ TH505		HSS	NPT	GS	USCTI 311	2 ~ 3P		Bright Steam Oxide TiCN	192
T7546/T8546		HSS	NPTF	GS	USCTI 311	2 ~ 3P		Bright TiN	193



HIGH PERFORMANCE TAPS RECOMMENDATION TABLE

Super HSS : Premium HSS Metallurgy
 P-HSS : Powdered Metallurgy
 HSSE-V3 : 3% Vanadium Alloy HSS-EX
 HSS-V : Vanadium Alloy HSS

⊙ = RECOMMENDED
 ○ = SUITABLE

COOLANT
 A = Cutting Oil
 T = Oil Emulsion
 X = Cutting Oil/Oil Emulsion

Material Group	Material Sub-Group	ISO	Hardness (HRc)	Hardness (BHN)	Cutting Speed (SFM)		COOLANT	MU			MU			MU			
					Uncoated	Coated		T2	T2-S	T2-C	T5	T5-S	T5-C	T6	T6-N		
Steel	Low carbon steels Free machining carbon steels	P	<15	<180	25 - 50	50 - 80	T	⊙	⊙	⊙	⊙	⊙	⊙	⊙	⊙	⊙	⊙
	Medium to high carbon steels Low alloyed steels	P	<23	<240	25 - 50	50 - 80	T	⊙	⊙	⊙	⊙	⊙	⊙	⊙	⊙	⊙	⊙
	Steel castings & forgings Heat-treatable alloy steels	P	>24 ≤38	>250 ≤350	6 - 30	10 - 35	X	⊙	⊙	⊙	⊙	⊙	⊙	⊙	⊙	⊙	⊙
	Alloyed tool steels Mold steels	P	>38 ≤44	>350 ≤420	6 - 12	-	A	⊙	⊙	⊙	⊙	⊙	⊙	⊙	⊙	⊙	⊙
Stainless Steel	Free machining stainless steels	M	<23	<240	12 - 35	20 - 50	A	⊙	⊙	⊙	⊙	⊙	⊙	⊙	⊙	⊙	⊙
	Heat-and corrosion-resistant stainless steels Valve stainless steels	M	>24 ≤38	>250 ≤350	12 - 15	12 - 15	A	⊙	⊙	⊙	⊙	⊙	⊙	⊙	⊙	⊙	⊙
	Stainless steel castings Precipitation hardening stainless steels	M	>38 ≤44	>350 ≤420	12 - 15	-	A	⊙	⊙	⊙	⊙	⊙	⊙	⊙	⊙	⊙	⊙
Aluminum	Pure Aluminum Aluminum alloys	N	-	-	50 - 65	-	T	⊙	⊙	⊙	⊙	⊙	⊙	⊙	⊙	⊙	⊙
	Aluminum alloy castings	N	-	-	40 - 65	45 - 90	T	⊙	⊙	⊙	⊙	⊙	⊙	⊙	⊙	⊙	⊙
Cast Iron	Grey cast iron	K	-	≤220	35 - 50	50 - 65	T	⊙	⊙	⊙	⊙	⊙	⊙	⊙	⊙	⊙	⊙
	Nodular cast iron / Chilled cast iron Meehanite iron / Ductile iron	K	-	≥250	12 - 45	25 - 55	X	⊙	⊙	⊙	⊙	⊙	⊙	⊙	⊙	⊙	⊙
Nickel Alloys	718 & 625 INCON / Waspaloy Hastelloy / Invar Monel / Incoloy	S	≤38	≤350	10 - 15	-	A	○	○	○	○	○	○	○	○	○	○
	718 Inconel A286	S	>38 ≤44	>350 ≤420	10 - 12	-	A	○	○	○	○	○	○	○	○	○	○
Titanium		S	≤38	≤350	3 - 15	-	A	○	○	○	○	○	○	○	○	○	○
Copper	Pure and alloyed copper	N	-	-	50 - 60	65 - 100	T	⊙	⊙	⊙	⊙	⊙	⊙	⊙	⊙	⊙	⊙
Brass	Free machining brass Alloyed brass	N	-	-	30 - 65	-	T	⊙	⊙	⊙	⊙	⊙	⊙	⊙	⊙	⊙	⊙
Bronze		N	44	<420	12 - 20	35 - 80	T	⊙	⊙	⊙	⊙	⊙	⊙	⊙	⊙	⊙	⊙
Zinc		N	-	-	25 - 65	50 - 80	T	⊙	⊙	⊙	⊙	⊙	⊙	⊙	⊙	⊙	⊙
Magnesium		N	-	-	-	45 - 100	T	⊙	⊙	⊙	⊙	⊙	⊙	⊙	⊙	⊙	⊙

MU	MU	MU	MU	MU	VA	VA	MU	MU		
T8 T8-N	T7 T7-C	T9 T9-C	T1-S	T1-C	TA-S	TA-C	T4 T4-S	T4 T4-C	T3 T3-S	T3 T3-C
USCTI 302A	USCTI 302A	USCTI 302A	DIN-ANSI Shank	DIN-ANSI Shank	USCTI 302A	USCTI 302A	USCTI 302A	USCTI 302A	USCTI 302A	USCTI 302A
45	46	48	49	50	51	53	54	56		
M	UNC/UNF	M	UNC/UNF	M	UNC/UNF	M	UNC/UNF	M		
HSS-EX	HSS-EX	HSS-EX	HSS-EX	HSS-EX	Super HSS HSS-EX	Super HSS HSS-EX	HSS-EX	HSS-EX		
2-3P	1-2P	1-2P	2-3P	2-3P	2-3P	2-3P	4-5P	4-5P		
Bright TiN	Bright TiCN	Bright TiCN	Steam Oxide TiCN	Steam Oxide TiCN	Steam Oxide TiCN	Steam Oxide TiCN	Bright Steam Oxide TiCN	Bright Steam Oxide TiCN		
R40°	R40°	R40°	R40°	R40°	R45°	R45°	-	-		
2.5D	2.5D	2.5D	2.5D	2.5D	2.5D	2.5D	3.0D	3.0D		
Blind	Blind	Blind	Blind	Blind	Blind	Blind	Through	Through		





HIGH PERFORMANCE TAPS RECOMMENDATION TABLE

Super HSS : Premium HSS Metallurgy
 P-HSS : Powdered Metallurgy
 HSSE-V3 : 3% Vanadium Alloy HSS-EX
 HSS-V : Vanadium Alloy HSS

◎ = RECOMMENDED
 ○ = SUITABLE

COOLANT
 A = Cutting Oil
 T = Oil Emulsion
 X = Cutting Oil/Oil Emulsion

Material Group	Material Sub-Group	ISO	Hardness (HRc)	Hardness (BHN)	Cutting Speed (SFM)		COOLANT	MU			
					Uncoated	Coated		TB-TB-N	TH-TH-N	TC-S	TC-C
Steel	Low carbon steels Free machining carbon steels	P	<15	<180	25 - 50	50 - 80	T	◎	◎	◎	◎
	Medium to high carbon steels Low alloyed steels	P	<23	<240	25 - 50	50 - 80	T	◎	◎	◎	◎
	Steel castings & forgings Heat-treatable alloy steels	P	>24 ≤38	>250 ≤350	6 - 30	10 - 35	X	◎	◎	◎	◎
	Alloyed tool steels Mold steels	P	>38 ≤44	>350 ≤420	6 - 12	-	A	◎	◎	◎	◎
Stainless Steel	Free machining stainless steels	M	<23	<240	12 - 35	20 - 50	A	◎	◎	◎	◎
	Heat-and corrosion-resistant stainless steels Valve stainless steels	M	>24 ≤38	>250 ≤350	12 - 15	12 - 15	A	◎	◎	◎	◎
	Stainless steel castings Precipitation hardening stainless steels	M	>38 ≤44	>350 ≤420	12 - 15	-	A	◎	◎	◎	◎
Aluminum	Pure Aluminum Aluminum alloys	N	-	-	50 - 65	-	T	◎	◎	◎	◎
	Aluminum alloy castings	N	-	-	40 - 65	45 - 90	T	◎	◎	◎	◎
Cast Iron	Grey cast iron	K	-	≤220	35 - 50	50 - 65	T	◎	◎	◎	◎
	Nodular cast iron / Chilled cast iron Meehanite iron / Ductile iron	K	-	≥250	12 - 45	25 - 55	X	◎	◎	◎	◎
Nickel Alloys	718 & 625 INCON / Waspaloy Hastelloy / Invar Monel / Incoloy	S	≤38	≤350	10 - 15	-	A	○	○	○	○
	718 Inconel A286	S	>38 ≤44	>350 ≤420	10 - 12	-	A	○	○	○	○
Titanium		S	≤38	≤350	3 - 15	-	A	○	○	○	○
Copper	Pure and alloyed copper	N	-	-	50 - 60	65 - 100	T	◎	◎	◎	◎
Brass	Free machining brass Alloyed brass	N	-	-	30 - 65	-	T	◎	◎	◎	◎
Bronze		N	44	<420	12 - 20	35 - 80	T	◎	◎	◎	◎
Zinc		N	-	-	25 - 65	50 - 80	T	◎	◎	◎	◎
Magnesium		N	-	-	-	45 - 100	T	◎	◎	◎	◎

MU		VA	VA	VG	VG	VG	VG	HR	HR
TK-S	TK-C	TCE-S/C TCF-S/C	TCG-S/C TCH-S/C	BB/BI	BH/BM	BF/BK	BD/BO	H5/H7/H8	TO858/ TK858/ TR858
DIN-ANSI Shank		USCTI 302A	USCTI 302A	USCTI 302A	USCTI 302A	DIN-ANSI Shank	DIN-ANSI Shank	USCTI 302A	USCTI 302A
60		61	63	68	70	71	72	73	74
M		UNC/UNF	M	UNC/UNF	M/MF	UNC/UNF	M/MF	UNC/UNF	M/MF
HSS-EX		Super HSS HSS-EX	Super HSS HSS-EX	Super HSS	Super HSS	Super HSS	Super HSS	P-HSS	P-HSS
4-5P		4P	4P	2-3P	2-3P	2-3P	2-3P	2-3P	2-3P
Steam Oxide	TiCN	Steam Oxide TiCN	Steam Oxide TiCN	Steam Oxide Hardslick	Steam Oxide Hardslick	Steam Oxide Hardslick	Steam Oxide Hardslick	Steam Oxide TiCN Hardslick	Steam Oxide TiCN Hardslick
-		-	-	R40°	R40°	R40°	R40°	R15°	R15°
3.0D		3.0D	3.0D	2.5D	2.5D	2.5D	2.5D	2.5D	2.5D
Through		Through	Through	Blind	Blind	Blind	Blind	Blind	Blind
◎	◎	○	○	○	○	○	○		
◎	◎	○	○	◎	◎	◎	◎		
◎	◎			◎	◎	◎	◎	○	○
◎	◎							◎	◎
◎	◎	◎	◎	◎	◎	◎	◎		
◎	◎			○	○	○	○		
◎	◎								
◎	◎								
◎	◎								
◎	◎			○	○	○	○		
◎	◎								
◎	◎							◎	◎
◎	◎			○	○	○	○		
◎	◎			○	○	○	○		



HIGH PERFORMANCE TAPS RECOMMENDATION TABLE

Super HSS : Premium HSS Metallurgy
P-HSS : Powdered Metallurgy
HSSE-V3 : 3% Vanadium Alloy HSS-EX
HSS-V : Vanadium Alloy HSS

⊙ = RECOMMENDED
○ = SUITABLE

COOLANT
A = Cutting Oil
T = Oil Emulsion
X = Cutting Oil/Oil Emulsion

Material Group	Material Sub-Group	ISO	Hardness (HRc)	Hardness (BHN)	Cutting Speed (SFM)		COOLANT			
					Uncoated	Coated				
Steel	Low carbon steels Free machining carbon steels	P	<15	<180	25 - 50	50 - 80	T		○	○
	Medium to high carbon steels Low alloyed steels	P	<23	<240	25 - 50	50 - 80	T		⊙	⊙
	Steel castings & forgings Heat-treatable alloy steels	P	>24 ≤38	>250 ≤350	6 - 30	10 - 35	X			
	Alloyed tool steels Mold steels	P	>38 ≤44	>350 ≤420	6 - 12	-	A			
Stainless Steel	Free machining stainless steels	M	<23	<240	12 - 35	20 - 50	A		⊙	⊙
	Heat-and corrosion-resistant stainless steels Valve stainless steels	M	>24 ≤38	>250 ≤350	12 - 15	12 - 15	A			
	Stainless steel castings Precipitation hardening stainless steels	M	>38 ≤44	>350 ≤420	12 - 15	-	A			
	Pure Aluminum Aluminum alloys	N	-	-	50 - 65	-	T		○	○
Aluminum	Aluminum alloy castings	N	-	-	40 - 65	45 - 90	T			⊙
	Grey cast iron	K	-	≤220	35 - 50	50 - 65	T			
Cast Iron	Nodular cast iron / Chilled cast iron Meehanite iron / Ductile iron	K	-	≥250	12 - 45	25 - 55	X			
	718 & 625 INCON / Waspaloy Hastelloy / Invar Monel / Incoloy	S	≤38	≤350	10 - 15	-	A	⊙		
Nickel Alloys	718 Inconel A286	S	>38 ≤44	>350 ≤420	10 - 12	-	A	⊙		
	Titanium	S	≤38	≤350	3 - 15	-	A	⊙		
Copper	Pure and alloyed copper	N	-	-	50 - 60	65 - 100	T		○	○
Brass	Free machining brass Alloyed brass	N	-	-	30 - 65	-	T		○	○
Bronze		N	44	<420	12 - 20	35 - 80	T			
Zinc		N	-	-	25 - 65	50 - 80	T		○	○
Magnesium		N	-	-	-	45 - 100	T		○	○

VG	VA	VA	VA	VG	VG	VG	AI
BG/BG-GB	B1/B0/B2/D2	BS/BT	E6/E8/E9	D3/E0	BU/BV	E2/E4/E5	C0/D8
DIN-ANSI Shank	USCTI 302A	USCTI 302A	DIN-ANSI Shank	USCTI 302A	USCTI 302A	DIN-ANSI Shank	USCTI 302A
79	80	83	84	85	88	90	91
UNC/UN8	UNC/UNF	M/MF	M/MF	UNC/UNF	M/MF	M/MF	UNC/UNF
HSSE-V3	HSSE-V3	HSSE-V3	HSSE-V3	HSSE-V3	HSSE-V3	HSSE-V3	HSSE-V3
2-3P	2-3P	2-3P	2-3P	2-3P	2-3P	2-3P	2-3P
Hardslick Gold & Black	Bright Steam Oxide TiN Hardslick	Steam Oxide Hardslick	Steam Oxide TiCN Hardslick	Steam Oxide Hardslick	Steam Oxide Hardslick	Steam Oxide TiCN Hardslick	Bright Hardslick
R40°	R45°	R45°	R45°	R45°	R45°	R45°	R50°
2.5D	2.5D	2.5D	2.5D	2.5D	2.5D	2.5D	2.5D
Blind	Blind	Blind	Blind	Blind	Blind	Blind	Blind
	○	○	○	○	○	○	
○	⊙	⊙	⊙	⊙	⊙	⊙	
⊙				○	○	○	
○	○	○	○				⊙
							⊙



HIGH PERFORMANCE TAPS RECOMMENDATION TABLE

Super HSS : Premium HSS Metallurgy
 P-HSS : Powdered Metallurgy
 HSSE-V3 : 3% Vanadium Alloy HSS-EX
 HSS-V : Vanadium Alloy HSS

⊙ = RECOMMENDED
 ○ = SUITABLE

COOLANT
 A = Cutting Oil
 T = Oil Emulsion
 X = Cutting Oil/Oil Emulsion

Material Group	Material Sub-Group	ISO	Hardness (HRc)	Hardness (BHN)	Cutting Speed (SFM)		COOLANT	VG	VG	HR
					Uncoated	Coated				
Steel	Low carbon steels Free machining carbon steels	P	<15	<180	25 - 50	50 - 80	T	○	○	
	Medium to high carbon steels Low alloyed steels	P	<23	<240	25 - 50	50 - 80	T	⊙	⊙	
	Steel castings & forgings Heat-treatable alloy steels	P	>24 ≤38	>250 ≤350	6 - 30	10 - 35	X	⊙	⊙	○
	Alloyed tool steels Mold steels	P	>38 ≤44	>350 ≤420	6 - 12	-	A			⊙
Stainless Steel	Free machining stainless steels	M	<23	<240	12 - 35	20 - 50	A	⊙	⊙	
	Heat-and corrosion-resistant stainless steels Valve stainless steels	M	>24 ≤38	>250 ≤350	12 - 15	12 - 15	A	⊙	⊙	○
	Stainless steel castings Precipitation hardening stainless steels	M	>38 ≤44	>350 ≤420	12 - 15	-	A			⊙
Aluminum	Pure Aluminum Aluminum alloys	N	-	-	50 - 65	-	T	○	○	
	Aluminum alloy castings	N	-	-	40 - 65	45 - 90	T			
Cast Iron	Grey cast iron	K	-	≤220	35 - 50	50 - 65	T			
	Nodular cast iron / Chilled cast iron Meehanite iron / Ductile iron	K	-	≥250	12 - 45	25 - 55	X			
Nickel Alloys	718 & 625 INCON / Waspaloy Hastelloyn / Invar Monel / Incoloy	S	≤38	≤350	10 - 15	-	A			○
	718 Inconel A286	S	>38 ≤44	>350 ≤420	10 - 12	-	A			○
Titanium		S	≤38	≤350	3 - 15	-	A			○
Copper	Pure and alloyed copper	N	-	-	50 - 60	65 - 100	T	○	○	
Brass	Free machining brass Alloyed brass	N	-	-	30 - 65	-	T	○	○	
Bronze		N	44	<420	12 - 20	35 - 80	T			⊙
Zinc		N	-	-	25 - 65	50 - 80	T	○	○	
Magnesium		N	-	-	-	45 - 100	T	○	○	

HR	Ti / Ni	VA	VA	VA	VA	VG	VG	VG
TQ808/ TK808/ TR808	I3/I5/J6	M2/M3	I0/I2/J2	O9/I1A	K3/K5/K6	J3/J8	IB/IC	J9/K7/K2
USCTI 302A	USCTI 302A	USCTI Long Shank	USCTI 302A	USCTI 302A	DIN-ANSI Shank	USCTI 302A	USCTI 302A	DIN-ANSI Shank
112	113	115	116	119	120	121	125	127
M/MF	UNC/UNF	UNC/UNF	UNC/UNF	M/MF	M/MF	UNC/UNF	M/MF	M/MF
P-HSS	P-HSS	P-HSS	HSSE-V3	HSSE-V3	HSSE-V3	HSSE-V3	HSSE-V3	HSSE-V3
4-5P	4-5P	4-5P	4-5P	4-5P	4-5P	4-5P	4-5P	4-5P
Steam Oxide TiCN Hardslick	Steam Oxide TiCN Hardslick	Hardslick	Steam Oxide TiN Hardslick	Steam Oxide Hardslick	Steam Oxide TiCN Hardslick	Steam Oxide Hardslick	Steam Oxide Hardslick	Steam Oxide TiCN Hardslick
-	-	-	-	-	-	-	-	-
3.0D	3.0D	3.0D	3.0D	3.0D	3.0D	3.0D	3.0D	3.0D
Through	Through	Through	Through	Through	Through	Through	Through	Through
○		○	○	○	○			
		⊙	⊙	⊙	⊙	⊙	⊙	⊙
○						⊙	⊙	⊙
⊙								
		⊙	⊙	⊙	⊙	○	○	○
○						○	○	○
○								
○	⊙							
○	⊙							
○	⊙							
		○	○	○	○			
		○	○	○	○			
⊙								
		○	○	○	○			
		○	○	○	○			



HIGH PERFORMANCE TAPS RECOMMENDATION TABLE

Super HSS : Premium HSS Metallurgy
 P-HSS : Powdered Metallurgy
 HSSE-V3 : 3% Vanadium Alloy HSS-EX
 HSS-V : Vanadium Alloy HSS

⊙ = RECOMMENDED
 ○ = SUITABLE

COOLANT
 A = Cutting Oil
 T = Oil Emulsion
 X = Cutting Oil/Oil Emulsion

Material Group	Material Sub-Group	ISO	Hardness (HRc)	Hardness (BHN)	Cutting Speed (SFM)		COOLANT	AI	AI	GS
					Uncoated	Coated				
Steel	Low carbon steels Free machining carbon steels	P	<15	<180	25 - 50	50 - 80	T	⊙	⊙	⊙
	Medium to high carbon steels Low alloyed steels	P	<23	<240	25 - 50	50 - 80	T	⊙	⊙	⊙
	Steel castings & forgings Heat-treatable alloy steels	P	>24 ≤38	>250 ≤350	6 - 30	10 - 35	X	○	○	○
	Alloyed tool steels Mold steels	P	>38 ≤44	>350 ≤420	6 - 12	-	A	○	○	○
Stainless Steel	Free machining stainless steels	M	<23	<240	12 - 35	20 - 50	A	○	○	○
	Heat-and corrosion-resistant stainless steels Valve stainless steels	M	>24 ≤38	>250 ≤350	12 - 15	12 - 15	A	○	○	○
	Stainless steel castings Precipitation hardening stainless steels	M	>38 ≤44	>350 ≤420	12 - 15	-	A	○	○	○
Aluminum	Pure Aluminum Aluminum alloys	N	-	-	50 - 65	-	T	⊙	⊙	○
	Aluminum alloy castings	N	-	-	40 - 65	45 - 90	T	⊙	⊙	○
Cast Iron	Grey cast iron	K	-	≤220	35 - 50	50 - 65	T	○	○	○
	Nodular cast iron / Chilled cast iron Meehanite iron / Ductile iron	K	-	≥250	12 - 45	25 - 55	X	○	○	○
Nickel Alloys	718 & 625 INCON / Waspaloy Hastelloy / Invar Monel / Incoloy	S	≤38	≤350	10 - 15	-	A	○	○	○
	718 Inconel A286	S	>38 ≤44	>350 ≤420	10 - 12	-	A	○	○	○
Titanium		S	≤38	≤350	3 - 15	-	A	○	○	○
Copper	Pure and alloyed copper	N	-	-	50 - 60	65 - 100	T	○	○	○
Brass	Free machining brass Alloyed brass	N	-	-	30 - 65	-	T	○	○	○
Bronze		N	44	<420	12 - 20	35 - 80	T	○	○	○
Zinc		N	-	-	25 - 65	50 - 80	T	○	○	○
Magnesium		N	-	-	-	45 - 100	T	○	○	○

GS	GS	GS	GS	GS	GS	GS	GS
K9/L0/L1	L7/L8/L9	L3/L4/L5	T7216/T6216/T8216 T7C16/T6C16/T8C16	T7256 /T6256	T7217/T6217/ T8217	T7226/T6226/ T8226	T7B17/T6B17/ T8B17
USCTI 302A	USCTI 302A	DIN-ANSI Shank	USCTI 302	USCTI 302	USCTI 302	USCTI Oversize	USCTI Oversize
131	132	133	134	138	140	141	142
UNC/UNF	M/MF	UNC/UNF	UNC/UNF	UNC/UNF	M/MF	UNC/UNF	M/MF
HSS-V	HSS-V	HSS-V	HSS	HSS	HSS	HSS	HSS
4-5P	4-5P	4-5P	4-5P	1.5-2P	4-5P	4-5P	4-5P
Bright TiN Hardslick	Bright TiCN Hardslick	Bright TiN Hardslick	Bright Steam Oxide TiN	Bright Steam Oxide	Bright Steam Oxide TiN	Bright Steam Oxide TiN	Bright Steam Oxide TiN
-	-	-	-	-	-	-	-
3.0D	3.0D	3.0D	3.0D	3.0D	3.0D	3.0D	3.0D
Through	Through	Through	Through	Through	Through	Through	Through



HIGH PERFORMANCE TAPS RECOMMENDATION TABLE

Super HSS : Premium HSS Metallurgy
 P-HSS : Powdered Metallurgy
 HSSE-V3 : 3% Vanadium Alloy HSS-EX
 HSS-V : Vanadium Alloy HSS

⊙ = RECOMMENDED
 ○ = SUITABLE

COOLANT
 A = Cutting Oil
 T = Oil Emulsion
 X = Cutting Oil/Oil Emulsion

Material Group	Material Sub-Group	ISO	Hardness (HRc)	Hardness (BHN)	Cutting Speed (SFM)		COOLANT	Image 1	Image 2
					Uncoated	Coated			
Steel	Low carbon steels Free machining carbon steels	P	<15	<180	25 - 50	50 - 80	T	⊙	
	Medium to high carbon steels Low alloyed steels	P	<23	<240	25 - 50	50 - 80	T	⊙	
	Steel castings & forgings Heat-treatable alloy steels	P	>24 ≤38	>250 ≤350	6 - 30	10 - 35	X	○	
	Alloyed tool steels Mold steels	P	>38 ≤44	>350 ≤420	6 - 12	-	A		
Stainless Steel	Free machining stainless steels	M	<23	<240	12 - 35	20 - 50	A	○	
	Heat-and corrosion-resistant stainless steels Valve stainless steels	M	>24 ≤38	>250 ≤350	12 - 15	12 - 15	A	○	
	Stainless steel castings Precipitation hardening stainless steels	M	>38 ≤44	>350 ≤420	12 - 15	-	A		
Aluminum	Pure Aluminum Aluminum alloys	N	-	-	50 - 65	-	T		
	Aluminum alloy castings	N	-	-	40 - 65	45 - 90	T	○	⊙
Cast Iron	Grey cast iron	K	-	≤220	35 - 50	50 - 65	T		⊙
	Nodular cast iron / Chilled cast iron Meehanite iron / Ductile iron	K	-	≥250	12 - 45	25 - 55	X	○	⊙
Nickel Alloys	718 & 625 INCON / Waspaloy Hastelloy / Invar Monel / Incoloy	S	≤38	≤350	10 - 15	-	A		
	718 Inconel A286	S	>38 ≤44	>350 ≤420	10 - 12	-	A		
Titanium		S	≤38	≤350	3 - 15	-	A		
Copper	Pure and alloyed copper	N	-	-	50 - 60	65 - 100	T		⊙
Brass	Free machining brass Alloyed brass	N	-	-	30 - 65	-	T		
Bronze		N	44	<420	12 - 20	35 - 80	T		
Zinc		N	-	-	25 - 65	50 - 80	T		
Magnesium		N	-	-	-	45 - 100	T		

GG	GG	GG	GG	GS	GS	GS	GS
TR		TR-A, TR-R		T7316/T6316/T8316 T7A16/T7B16	T7315/T6315/ T8315	T7326	T7B15
USCTI 302A	USCTI 302A	USCTI 302A	USCTI 302A	USCTI 302	USCTI 302	USCTI Oversize	USCTI Oversize
148		150		152	158	159	160
UNC/UNF	M	UNC/UNF	M	UNC/UNF/UNS	M/MF	UNC/UNF	UNC/UNF
Super HSS	Super HSS	Super HSS	Super HSS	HSS	HSS	HSS	HSS
2P~3P	2P~3P	2P~3P	2P~3P	9P / 5P / 2P	9P / 5P / 2P	5P / 2P	5P / 2P
TiAIN	TiAIN	TiAIN	TiAIN	Bright Steam Oxide TiN	Bright Steam Oxide TiN	Bright	Bright
-	-	-	-	-	-	-	-
2.0D	2.0D	2.0D	2.0D	2.0D	2.0D	2.0D	2.0D
Blind Through	Blind Through	Blind Through	Blind Through	Blind Through	Blind Through	Blind Through	Blind Through
				⊙	⊙	⊙	⊙
				⊙	⊙	⊙	⊙
				⊙	⊙	⊙	⊙
⊙	⊙	⊙	⊙	⊙	⊙	⊙	⊙
⊙	⊙	⊙	⊙				
				⊙	⊙	⊙	⊙
				⊙	⊙	⊙	⊙
				⊙	⊙	⊙	⊙
				⊙	⊙	⊙	⊙









HIGH PERFORMANCE TAPS RECOMMENDATION TABLE

Super HSS : Premium HSS Metallurgy
 P-HSS : Powdered Metallurgy
 HSSE-V3 : 3% Vanadium Alloy HSS-EX
 HSS-V : Vanadium Alloy HSS

◎ = RECOMMENDED
 ○ = SUITABLE

COOLANT
 A = Cutting Oil
 T = Oil Emulsion
 X = Cutting Oil/Oil Emulsion

Material Group	Material Sub-Group	ISO	Hardness (HRc)	Hardness (BHN)	Cutting Speed (SFM)		COOLANT	T7336 (LH)	T7A15 (LH)	T7616/T6616/T8616
					Uncoated	Coated				
Steel	Low carbon steels Free machining carbon steels	P	<15	<180	25 – 50	50 – 80	T	◎	◎	◎
	Medium to high carbon steels Low alloyed steels	P	<23	<240	25 – 50	50 – 80	T	◎	◎	◎
	Steel castings & forgings Heat-treatable alloy steels	P	>24 ≤38	>250 ≤350	6 – 30	10 – 35	X			
	Alloyed tool steels Mold steels	P	>38 ≤44	>350 ≤420	6 – 12	–	A			
Stainless Steel	Free machining stainless steels	M	<23	<240	12 – 35	20 – 50	A	◎	◎	◎
	Heat-and corrosion-resistant stainless steels Valve stainless steels	M	>24 ≤38	>250 ≤350	12 – 15	12 – 15	A			
	Stainless steel castings Precipitation hardening stainless steels	M	>38 ≤44	>350 ≤420	12 – 15	–	A			
Aluminum	Pure Aluminum Aluminum alloys	N	–	–	50 – 65	–	T	◎	◎	◎
	Aluminum alloy castings	N	–	–	40 – 65	45 – 90	T	◎	◎	◎
Cast Iron	Grey cast iron	K	–	≤220	35 – 50	50 – 65	T			
	Nodular cast iron / Chilled cast iron Meehanite iron / Ductile iron	K	–	≥250	12 – 45	25 – 55	X			
Nickel Alloys	718 & 625 INCON / Waspaloy Hastelloy / Invar Monel / Incoloy	S	≤38	≤350	10 – 15	–	A			
	718 Inconel A286	S	>38 ≤44	>350 ≤420	10 – 12	–	A			
Titanium		S	≤38	≤350	3 – 15	–	A			
Copper	Pure and alloyed copper	N	–	–	50 – 60	65 – 100	T	◎	◎	◎
Brass	Free machining brass Alloyed brass	N	–	–	30 – 65	–	T	◎	◎	◎
Bronze		N	44	<420	12 – 20	35 – 80	T			
Zinc		N	–	–	25 – 65	50 – 80	T	◎	◎	◎
Magnesium		N	–	–	–	45 – 100	T	◎	◎	◎

GV	GV	GV	GV	GV	GV	GS	GS
TKR03	ZF	Z0/Z1/Z2/Z3	Z4/Z5/Z6/Z7	Z8/Z9/ZC/ZD	T7R01/T8R01/THR01 T7R02/T8R02/THR02	ST/SI	T7406
USCTI 302A	USCTI 302	USCTI 302A	USCTI 302A	USCTI 302A	USCTI 302A	USCTI 322	USCTI 322
167	168	169	171	173	174	177	178
UNC/UNF	UNC/UNF	UNC/UNF	UNC/UNF	M/MF	UNC/UNF	UNC/UNF	UNC/UNF
Super HSS	HSSE-V3	HSSE-V3	HSSE-V3	HSSE-V3	HSS	HSSE-V3	HSS
2-3P	1.5-2P	4-5P 1.5-2P	4-5P 1.5-2P	4-5P 1.5-2P	4-5P 1.5-2P	1.5-2P	1.5-2P
TiCN	Bright	Bright TiN	Bright TiN	Bright TiN TiCN	Bright TiN TiCN	Hardstick	Bright
-	-	-	-	-	-	R40°	R50°
3.0D	3.0D	3.0D	3.0D	3.0D	3.0D	2.5D	2.5D
Blind Through	Blind Through	Blind Through	Blind Through	Blind Through	Blind Through	Blind	Blind
							
◎	◎	◎	◎	◎	◎	◎	○
◎		◎	◎	◎	◎	◎	○
						○	
◎	◎	◎	◎	◎	○		
◎	◎	◎	◎	◎	◎	○	○
						○	○
◎		◎	◎	◎	○		
◎		◎	◎	◎	○		
◎		◎	◎	◎	○		
◎		◎	◎	◎	○		





HIGH PERFORMANCE TAPS RECOMMENDATION TABLE

Super HSS : Premium HSS Metallurgy
 P-HSS : Powdered Metallurgy
 HSSE-V3 : 3% Vanadium Alloy HSS-EX
 HSS-V : Vanadium Alloy HSS

◎ = RECOMMENDED
 ○ = SUITABLE

COOLANT
 A = Cutting Oil
 T = Oil Emulsion
 X = Cutting Oil/Oil Emulsion

Material Group	Material Sub-Group	ISO	Hardness (HRc)	Hardness (BHN)	Cutting Speed (SFM)		COOLANT			
					Uncoated	Coated				
Steel	Low carbon steels Free machining carbon steels	P	<15	<180	25 - 50	50 - 80	T	○	◎	○
	Medium to high carbon steels Low alloyed steels	P	<23	<240	25 - 50	50 - 80	T	○	◎	○
	Steel castings & forgings Heat-treatable alloy steels	P	>24 ≤38	>250 ≤350	6 - 30	10 - 35	X		○	
	Alloyed tool steels Mold steels	P	>38 ≤44	>350 ≤420	6 - 12	-	A			
Stainless Steel	Free machining stainless steels	M	<23	<240	12 - 35	20 - 50	A			
	Heat-and corrosion-resistant stainless steels Valve stainless steels	M	>24 ≤38	>250 ≤350	12 - 15	12 - 15	A			
	Stainless steel castings Precipitation hardening stainless steels	M	>38 ≤44	>350 ≤420	12 - 15	-	A			
Aluminum	Pure Aluminum Aluminum alloys	N	-	-	50 - 65	-	T	○	○	○
	Aluminum alloy castings	N	-	-	40 - 65	45 - 90	T	○	○	○
Cast Iron	Grey cast iron	K	-	≤220	35 - 50	50 - 65	T	○	○	○
	Nodular cast iron / Chilled cast iron Meehanite iron / Ductile iron	K	-	≥250	12 - 45	25 - 55	X			
Nickel Alloys	718 & 625 INCON / Waspaloy Hastelloy / Invar Monel / Incoloy	S	≤38	≤350	10 - 15	-	A			
	718 Inconel A286	S	>38 ≤44	>350 ≤420	10 - 12	-	A			
Titanium		S	≤38	≤350	3 - 15	-	A			
Copper	Pure and alloyed copper	N	-	-	50 - 60	65 - 100	T			
Brass	Free machining brass Alloyed brass	N	-	-	30 - 65	-	T			
Bronze		N	44	<420	12 - 20	35 - 80	T			
Zinc		N	-	-	25 - 65	50 - 80	T			
Magnesium		N	-	-	-	45 - 100	T			

GS	GS	GS	VA	GG	GG	GG	GS
T7415	T7426	T7405	Q1/Q0/Q6	Q9/R0/R1	R7/R8/R9/S0	S1/S2 (INTERRUPTED)	T7L36/T6L36 T7536/T6536
USCTI 322A	USCTI 322	USCTI 322A	USCTI 311	USCTI 311	USCTI 311	USCTI 311	USCTI 311
182	183	184	187	188	189	190	191
M/MF	UNC/UNF	M/MF	NPTF	NPTF	NPTF	NPTF	NPS/NPSF
HSS	HSS	HSS	HSSE-V3	HSSE-V3	HSSE-V3	HSSE-V3	HSS
4-5P	4-5P 1.5-2P	4-5P 1.5-2P	2-3P	2-3P	2-3P	2-3P	4-5P
Bright	Bright	Bright	Bright Steam Oxide Hardslick	Bright TiN Hardslick	Bright TiN Hardslick Nitrided-Steam Oxide	Bright TiCN	Bright Steam Oxide
-	-	-	R15°	R15°	-	-	-
3.0D	2.0D	2.0D	2.5D	2.5D	2.0D	2.0D	2.0D
Through	Blind Through	Blind Through	Blind	Blind Through	Blind Through	Blind Through	Blind Through
							
○	○	○	○	◎	◎	◎	○
○	○	○	◎	◎	◎	◎	○
			○	○	○	○	
			◎				
			○				
○	○	○					○
○	○	○	○				○
○	○	○		◎	◎	◎	○
			○	◎	◎	◎	



HIGH PERFORMANCE TAPS RECOMMENDATION TABLE

Super HSS : Premium HSS Metallurgy
 P-HSS : Powdered Metallurgy
 HSSE-V3 : 3% Vanadium Alloy HSS-EX
 HSS-V : Vanadium Alloy HSS

◎ = RECOMMENDED
 ○ = SUITABLE

COOLANT
 A = Cutting Oil
 T = Oil Emulsion
 X = Cutting Oil/Oil Emulsion

Material Group	Material Sub-Group	ISO	Hardness (HRc)	Hardness (BHN)	Cutting Speed (SFM)		COOLANT	Uncoated	Coated
					Uncoated	Coated			
Steel	Low carbon steels Free machining carbon steels	P	<15	<180	25 - 50	50 - 80	T	○	○
	Medium to high carbon steels Low alloyed steels	P	<23	<240	25 - 50	50 - 80	T	○	○
	Steel castings & forgings Heat-treatable alloy steels	P	>24 ≤38	>250 ≤350	6 - 30	10 - 35	X		
	Alloyed tool steels Mold steels	P	>38 ≤44	>350 ≤420	6 - 12	-	A		
Stainless Steel	Free machining stainless steels	M	<23	<240	12 - 35	20 - 50	A		
	Heat-and corrosion-resistant stainless steels Valve stainless steels	M	>24 ≤38	>250 ≤350	12 - 15	12 - 15	A		
	Stainless steel castings Precipitation hardening stainless steels	M	>38 ≤44	>350 ≤420	12 - 15	-	A		
Aluminum	Pure Aluminum Aluminum alloys	N	-	-	50 - 65	-	T	○	○
	Aluminum alloy castings	N	-	-	40 - 65	45 - 90	T	○	○
Cast Iron	Grey cast iron	K	-	≤220	35 - 50	50 - 65	T	○	○
	Nodular cast iron / Chilled cast iron Meehanite iron / Ductile iron	K	-	≥250	12 - 45	25 - 55	X		
Nickel Alloys	718 & 625 INCON / Waspaloy Hastelloy / Invar Monel / Incoloy	S	≤38	≤350	10 - 15	-	A		
	718 Inconel A286	S	>38 ≤44	>350 ≤420	10 - 12	-	A		
Titanium		S	≤38	≤350	3 - 15	-	A		
Copper	Pure and alloyed copper	N	-	-	50 - 60	65 - 100	T		
Brass	Free machining brass Alloyed brass	N	-	-	30 - 65	-	T		
Bronze		N	44	<420	12 - 20	35 - 80	T		
Zinc		N	-	-	25 - 65	50 - 80	T		
Magnesium		N	-	-	-	45 - 100	T		



CARBIDE

Being the best through innovation





SOLID CARBIDE THREAD MILL

- For blind holes and through holes with one single tool.
- Higher cutting speed and feed than taps.

SELECTION GUIDE

- For blind holes and through holes with one single tool.
- Higher cutting speed and feed than taps.

INCH

EDP No.	MODEL	Description	Page
TE		Solid Carbide Thread mill for Unified Internal Threads - ANSI B 1.1	33
TD		Solid Carbide Thread mill for Metric Internal Threads - DIN 13	34
TF TG		Solid Carbide Thread mill for Unified Internal Threads - ANSI B 1.20.1(NPT) / ANSI B1.20.3(NPTF)	35

YG SOLID CARBIDE THREAD MILLS

TE SERIES

SOLID CARBIDE THREAD MILL FOR UNIFIED INTERNAL THREADS - ANSI B 1.1

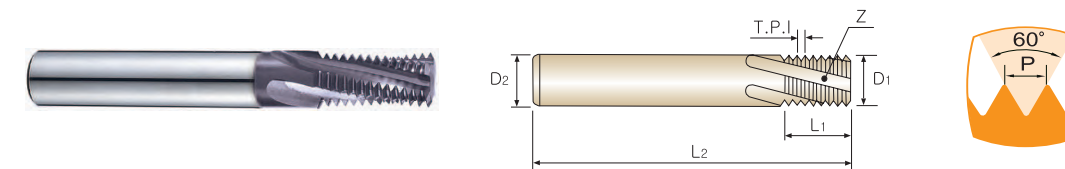

- ▶ Material : Solid Carbide
- ▶ Shank : Plain Straight
- ▶ Spiral Angle : 15°

Unit : Inch

EDP No.	SIZE	Pitch	Cutter Diameter	Shank Diameter	Thread Length	Overall Length	No. of Flute
TiAlN		TPI	D ₁	D ₂	L ₁	L ₂	Z
TE080	#2	56	.065	.125	.125	2.000	3
TE120	#3	48	.075	.125	.167	2.000	3
TE220	#5	44	.095	.125	.228	2.000	3
TE160	#4	40	.085	.125	.175	2.000	3
TE300	#8	36	.115	.125	.250	2.000	3
TE240	#6	32	.100	.125	.218	2.000	3
TE280	#8	32	.115	.125	.250	2.000	3
TE340	#10	32	.120	.125	.312	2.000	3
TEF90	1/2	32	.370	.375	1.000	3.500	4
TEK90	#10	28	.120	.125	.312	2.000	3
TE420	1/4	28	.180	.187	.500	2.500	3
TE590	1/2	28	.370	.375	1.000	3.500	4
TE320	#10	24	.120	.125	.312	2.000	3
TE460	5/16	24	.235	.250	.625	2.500	3
TE500	3/8	24	.285	.312	.750	3.000	4
TE570	1/2	24	.370	.375	1.000	3.500	4
TE400	1/4	20	.180	.187	.500	2.500	3
TE540	7/16	20	.335	.375	.875	3.500	4
TE580	1/2	20	.370	.375	1.000	3.500	4
TE440	5/16	18	.235	.250	.625	2.500	3
TE620	9/16	18	.370	.375	.875	3.500	4
TE480	3/8	16	.285	.312	.750	3.000	4
TE720	3/4	16	.490	.500	1.250	3.500	4
TE520	7/16	14	.305	.312	.750	3.000	4
TE760	7/8	14	.490	.500	1.250	3.500	4
TE560	1/2	13	.350	.375	.875	3.500	4
TE600	9/16	12	.370	.375	.875	3.500	4
TE710	3/4	12	.495	.500	1.250	3.500	4
TE640	5/8	11	.470	.500	1.250	3.500	4
TE700	3/4	10	.495	.500	1.250	3.500	4
TE740	7/8	9	.620	.625	1.375	4.000	4
TE780	1	8	.620	.625	1.375	4.000	4
TE800	1	12	.745	.750	1.500	4.000	5
TE820	1-1/8 & 1-1/4	7	.745	.750	1.572	4.500	5

◎ : Excellent ○ : Good

Carbon Steels	Alloy Steels	Heat Treated Steels	Cast Iron	Stainless Steels	Titanium Alloy	Chrome-Nickel Alloy	Non Ferrous Materials
◎	◎	◎	◎	○	○	○	◎

- HSS
- CARBIDE
- SOLID CARBIDE THREAD MILLS
- COMBO TAPS
- SPIRAL FLUTE TAPS
- SPIRAL POINT TAPS
- STRAIGHT FLUTE TAPS
- FORMING TAPS
- SCREW THREAD INSERT TAPS
- PIPE TAPS
- TECHNICAL DATA

Y/G SOLID CARBIDE THREAD MILLS

TD SERIES

SOLID CARBIDE THREAD MILL FOR METRIC INTERNAL THREADS - DIN 13

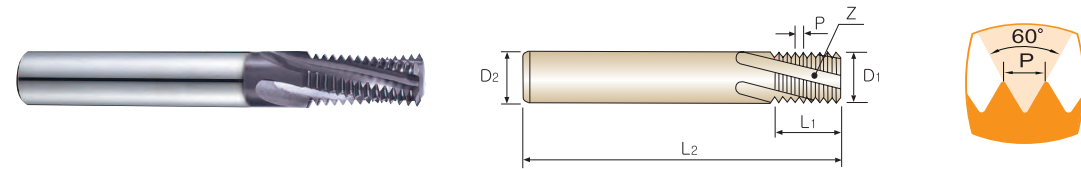

- Material : Solid Carbide
- Shank : Plain Straight
- Spiral Angle : 15°

Unit : Inch

EDP No.	SIZE	Pitch (mm)	Cutter Diameter	Shank Diameter	Thread Length	Overall Length	No. of Flute
TiAlN		P	D ₁	D ₂	L ₁	L ₂	Z
TD200	M3	0.50	.085	.125	.178	2.000	3
TD240	M4	0.70	.115	.125	.276	2.000	3
TD260	M4.5	0.75	.120	.125	.250	2.000	3
TD380	M8	0.75	.235	.250	.625	2.500	3
TD280	M5	0.80	.120	.125	.312	2.000	3
TD310	M6	1.00	.170	.187	.500	2.500	3
TD530	M12	1.00	.360	.375	.875	3.500	4
TD360	M8	1.25	.235	.250	.625	2.500	3
TD420	M10	1.50	.300	.312	.750	3.000	4
TD550	M14	1.50	.370	.375	.875	3.500	4
TD670	M18	1.50	.490	.500	1.250	3.500	4
TD500	M12	1.75	.360	.375	.875	3.500	4
TD600	M16	2.00	.470	.500	1.250	3.500	4
TD700	M20	2.50	.495	.500	1.250	3.500	4
TD780	M24	3.00	.620	.625	1.375	4.000	4

◎ : Excellent ○ : Good

Carbon Steels	Alloy Steels	Heat Treated Steels	Cast Iron	Stainless Steels	Titanium Alloy	Chrome-Nickel Alloy	Non Ferrous Materials
◎	◎	◎	◎	○	○	○	◎

Y/G SOLID CARBIDE THREAD MILLS

TF/TG SERIES

SOLID CARBIDE THREAD MILL FOR UNIFIED INTERNAL THREADS - ANSI B 1.20.1(NPT) / ANSI B1.20.3(NPTF)

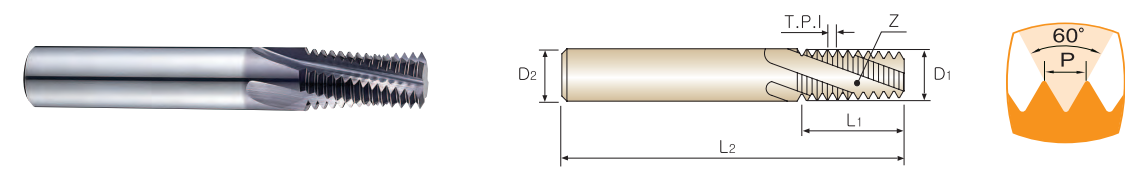

- Material : Solid Carbide
- Shank : Plain Straight
- Spiral Angle : 15°

TF Series (NPT)

Unit : Inch

EDP No.	SIZE	Pitch	Cutter Diameter	Shank Diameter	Thread Length	Overall Length	No. of Flute
TiAlN		T.P.I	D ₁	D ₂	L ₁	L ₂	Z
TF020	1/16 & 1/8	27	.245	.250	.437	2.500	3
TF400	1/4 & 3/8	18	.305	.312	.625	3.000	4
TF480	1/4 & 3/8	18	.363	.375	.680	3.500	4
TF560	1/2 & 3/4	14	.495	.500	.875	3.500	4
TF780	1" - 2"	11.5	.620	.625	1.125	4.000	4
TFF40	2-1/2" - 6"	8	.745	.750	1.500	5.000	4

TG Series (NPTF)

Unit : Inch

EDP No.	SIZE	Pitch	Cutter Diameter	Shank Diameter	Thread Length	Overall Length	No. of Flute
TiAlN		T.P.I	D ₁	D ₂	L ₁	L ₂	Z
TG020	1/16 & 1/8	27	.245	.250	.437	2.500	3
TG400	1/4 & 3/8	18	.305	.312	.625	3.000	4
TG560	1/2 & 3/4	14	.495	.500	.875	3.500	4
TG780	1" - 2"	11.5	.620	.625	1.125	4.000	4
TGF40	2-1/2" - 6"	8	.745	.750	1.500	5.000	4

◎ : Excellent ○ : Good

Carbon Steels	Alloy Steels	Heat Treated Steels	Cast Iron	Stainless Steels	Titanium Alloy	Chrome-Nickel Alloy	Non Ferrous Materials
◎	◎	◎	◎	○	○	○	◎

Y/G SOLID CARBIDE THREAD MILLS

Y/G SOLID CARBIDE THREAD MILLS

RECOMMENDED CUTTING SPEED

PROGRAMING OF THREAD MILLING

Application Program Available

Application Program Available

Unit : Inch

Material	Cutting Speed (SFM)	Feed per Tooth (fz)	
		Cutter Diameter < 5/16	Cutter Diameter > 5/16
Low Carbon Steels Medium Carbon Steels	250 - 400	.0008 - .0016	.0016 - .0040
High Carbon Steels	250 - 350	.0008 - .0016	.0016 - .0040
Alloy Steels	250 - 300	.0008 - .0016	.0016 - .0040
Heat Treated Steels	200 - 300	.0008 - .0016	.0016 - .0040
Stainless Steels	150 - 250	.0004 - .0008	.0008 - .0024
Cast Iron	200 - 350	.0008 - .0016	.0016 - .0040
Chrome-Nickel Alloys Titanium Alloys	70 - 200	.0004 - .0008	.0008 - .0024
Non Ferrous Material	350 - 1000	.0012 - .0020	.0020 - .0040

Program Data

G Codes for Thread Milling

- | | |
|--|--|
| G00 Fast Feed Linear | G90 Absolute Command |
| G01 Linear Movement | G91 Incremental Command |
| G02 Circular/Helical Interpolation C.W. | M03 Clockwise Rotation of Spindle |
| G03 Circular/Helical Interpolation A.C.W. | M05 Spindle Stop |
| G17 X, Y Plane (Vertical Machining) | M08 Coolant On |
| G18 Z, X Plane (Horizontal Machining) | X Horizontal Co-ordinate |
| G19 Y, Z Plane (Using 90° Head) | Y Horizontal Co-ordinate |
| G40 Cutter Radius Compensation Cancel | Z Vertical Co-ordinate |
| G41 Cutter Radius Compensation Left | I X Co-ordinate to Center of Arc Travel |
| G42 Cutter Radius Compensation Right | J Y Co-ordinate to Center of Arc Travel |
| G43 Tool Length Compensation Plus | S Spindle Speed R.P.M. |
| G49 Tool Length Compensation Cancel | F Feed inch/min |

CNC Internal Thread Milling

```

N10 G54 G90 G00 X... Y...
N20 G43 H10 Z0.250 M0.3 S...
N30 G91 G00 Z...(A3+0.250)
N40 G41 G01 D26 X...(A6) Y...(A5) F...
N50 G03 X...(A6) Y...(A6) Z...(A4) I...(A6) J0
N60 G03 X0 Y0 Z...(A2) I0 J...(A1)
N70 G03 X...(A6) Y...(A6) Z...(A4) I0 J...(A6)
N80 G00 G40 X...(A6) Y...(A5)
N90 G00 Z...(A7)
N100 G90 G49 G00 Z8.0 M5
N110 M30
    
```

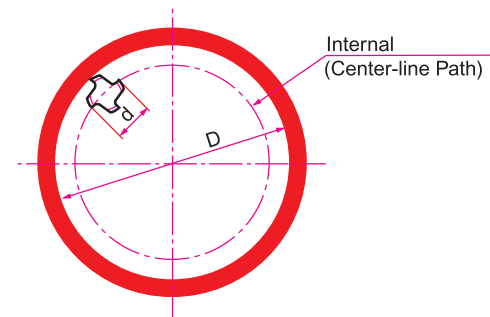

RECOMMENDED CUTTING SPEED

Calculate R.P.M of cutter

$$N = \frac{12 \times \text{SFM}}{d \times \pi}$$

- N** : R.P.M
- SFM** : Recommended Cutting Speed
- d** : Diameter of Cutter
- fz** : Recommended Feed per Tooth
- Z** : Number of Teeth
- F₁** : Feed at Cutting Edge
- F₂** : Feed at Center Line of Cutting
- D** : Major Diameter of Component

Calculate Feed per Revolution

$$F_1 = fz \times Z \times N$$

Calculate Feed at Tool Center Line

$$F_2 = \frac{F_1 \times (D - d)}{D}$$

<Explanation of Parameters>

- A1** : 1/2 Nominal Thread Diameter (D/2)
- A2** : Thread Pitch(P)
- A3** : Thread Depth
- A4** : P/4(for climb milling and right-hand thread)
- A5** : Beginning of Contour in Y (P/2)
- A6** : Arc Off (A1 - A5)
- A7** : A3 + 0.250 - P/2
- H10** : Tool length compensation number
- D26** : Tool radius compensation number

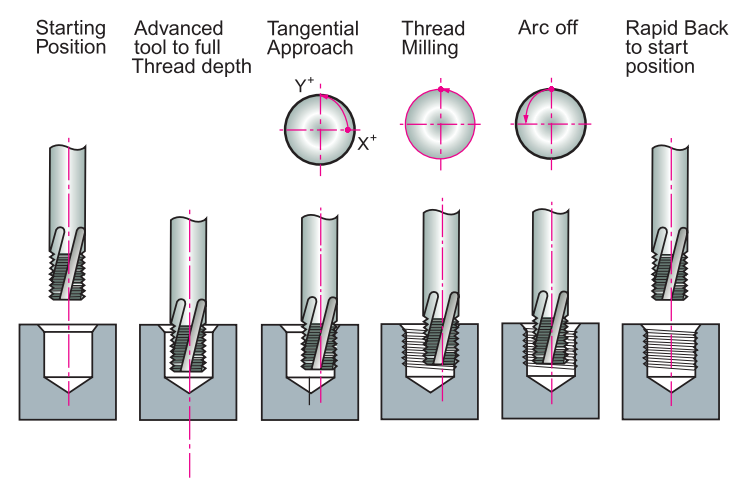

HARD *slick*

ULTIMATE TAP PERFORMANCE

Application Range

SOFT 70 BHN ————— HARD 340 BHN

**STEEL • STAINLESS STEEL
NICKEL ALLOYS
ALUMINUM**

- Reduces Galling & Seizing
- Extends Life with Minimal Coolant
- Reduces Tap Inventory

TAP SUBSTRATE -
67Rc .8 Coefficient of Friction

TIALN - 90Rc

WC/C - .2 Coefficient of Friction



Being the best through innovation

HSS



COMBO TAPS

- Spiral Point and Spiral Flute Taps



















Multi Purpose tapping / YG-1's Patent / Super HSS & HSS-E for Prevention of Oversized Threads

SELECTION GUIDE

Spiral Point and Spiral Flute Taps

Multi Purpose tapping / YG-1's Patent / Super HSS & HSS-E for Prevention of Oversized Threads

INCH

EDP No.	MODEL	Tool Material	Standard	Work Material	Dimensions	Tolerance	Chamfer	Thread Depth	Surface Treatment	Page
T2 T2-S T2-C		HSS-EX	UNC/UNF	MU	USCTI 302A	H2~H6	2 ~ 3P	2.5D	Bright Steam Oxide TiCN	41
T5 T5-S T5-C		HSS-EX	M	MU	USCTI 302A	D3~D8	2 ~ 3P		Bright Steam Oxide TiCN	43
T6 T6-N	with Internal Coolant 	HSS-EX	UNC/UNF	MU	USCTI 302A	H4~H6	2 ~ 3P		Bright TiN	44
T8 T8-N	with Internal Coolant 	HSS-EX	M	MU	USCTI 302A	D5~D7	2 ~ 3P		Bright TiN	45
T7 T7-C	Short Chamfer 	HSS-EX	UNC/UNF	MU	USCTI 302A	H2~H6	1 ~ 2P		Bright TiCN	46
T9 T9-C	Short Chamfer 	HSS-EX	M	MU	USCTI 302A	D3~D8	1 ~ 2P		Bright TiCN	48
T1-S T1-C		HSS-EX	UNC/UNF	MU	DIN-ANSI Shank	H2~H6	2 ~ 3P		Steam Oxide TiCN	49
TA-S TA-C		HSS-EX	M	MU	DIN-ANSI Shank	D3~D7	2 ~ 3P		Steam Oxide TiCN	50
TCA-S/C TCB-S/C		Super HSS HSS-EX	UNC/UNF	VA	USCTI 302A	H2~H6	2 ~ 3P		Steam Oxide TiCN	51
TCC-S/C TCD-S/C		Super HSS HSS-EX	M	VA	USCTI 302A	D3~D7	2 ~ 3P		Steam Oxide TiCN	53
T4 T4-S T4-C		HSS-EX	UNC/UNF	MU	USCTI 302A	H2~H6	4 ~ 5P	3.0D	Bright Steam Oxide TiCN	54
T3 T3-S T3-C		HSS-EX	M	MU	USCTI 302A	D3~D8	4 ~ 5P		Bright Steam Oxide TiCN	56
TB TB-N	with Internal Coolant 	HSS-EX	UNC/UNF	MU	USCTI 302A	H4~H6	4 ~ 5P		Bright TiN	57
TH TH-N	with Internal Coolant 	HSS-EX	M	MU	USCTI 302A	D5~D7	4 ~ 5P		Bright TiN	58
TC-S TC-C		HSS-EX	UNC/UNF	MU	DIN-ANSI Shank	H2~H6	4 ~ 5P		Steam Oxide TiCN	59
TK-S TK-C		HSS-EX	M	MU	DIN-ANSI Shank	D3~D7	4 ~ 5P		Steam Oxide TiCN	60
TCE-S/C TCF-S/C		Super HSS HSS-EX	UNC/UNF	VA	USCTI 302A	H2~H6	4P		Steam Oxide TiCN	61
TCE-S/C TCF-S/C		Super HSS HSS-EX	M	VA	USCTI 302A	D3~D7	4P		Steam Oxide TiCN	63

COMBO TAPS

Combo TAP

T2/T2-S/T2-C SERIES

SPIRAL FLUTE TAPS for Multi-Purpose

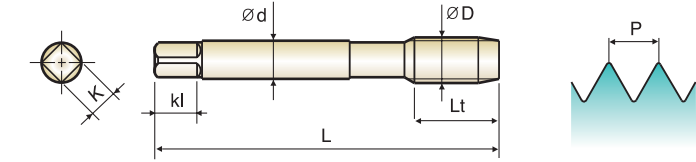
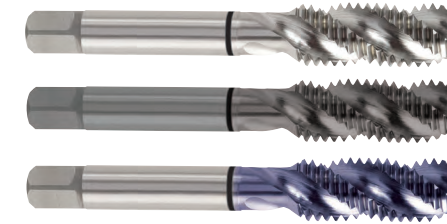

Hole type

2.5xD

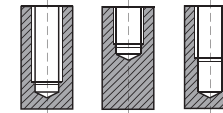

MU HSS-EX UNC UNF USCTI 302A H2~H6 60° 2P~3P Bright Steam Oxide TiCN R40

Unit : Inch

EDP No.			SIZE & TPI	Limit	Overall Length L	Thread Length Lt	Shank Diameter D	Square Size K	Square Length kl	No. of Flute
Bright	Steam Oxide	TiCN								
T2162	T2162S	T2162C	#4 - 40 UNC	H2	1.88	.236	.141	.110	.188	2
T2182	T2182S	T2182C	#4 - 48 UNF	H2	1.88	.236	.141	.110	.188	2
T2202	T2202S	T2202C	#5 - 40 UNC	H2	1.94	.236	.141	.110	.188	3
T2222	T2222S	T2222C	#5 - 44 UNF	H2	1.94	.236	.141	.110	.188	3
T2243	T2243S	T2243C	#6 - 32 UNC	H3	2.00	.276	.141	.110	.188	3
T2262	T2262S	T2262C	#6 - 40 UNF	H2	2.00	.276	.141	.110	.188	3
T2283	T2283S	T2283C	#8 - 32 UNC	H3	2.13	.276	.168	.131	.250	3
T2302	T2302S	T2302C	#8 - 36 UNF	H2	2.13	.276	.168	.131	.250	3
T2323	T2323S	T2323C	#10 - 24 UNC	H3	2.38	.354	.194	.152	.250	3
T2343	T2343S	T2343C	#10 - 32 UNF	H3	2.38	.276	.194	.152	.250	3
T2363	T2363S	T2363C	#12 - 24 UNC	H3	2.38	.354	.220	.165	.281	3
T2383	T2383S	T2383C	#12 - 28 UNF	H3	2.38	.276	.220	.165	.281	3
T2403	T2403S	T2403C	1/4 - 20 UNC	H3	2.50	.433	.255	.191	.312	3
T2405	T2405S	T2405C	1/4 - 20 UNC	H5	2.50	.433	.255	.191	.312	3
T2423	T2423S	T2423C	1/4 - 28 UNF	H3	2.50	.354	.255	.191	.312	3
T2424	T2424S	T2424C	1/4 - 28 UNF	H4	2.50	.354	.255	.191	.312	3
T2443	T2443S	T2443C	5/16 - 18 UNC	H3	2.72	.472	.318	.238	.375	3
T2445	T2445S	T2445C	5/16 - 18 UNC	H5	2.72	.472	.318	.238	.375	3
T2463	T2463S	T2463C	5/16 - 24 UNF	H3	2.72	.394	.318	.238	.375	3
T2465	T2465S	T2465C	5/16 - 24 UNF	H5	2.72	.394	.318	.238	.375	3

▶ Coating (TiN, TiAlN or Hardslick) is available on your request.

▶ Coating Codes for Combo Tap
Bright Finish No. + N(TiN), F(TiAlN), H(Hardslick)

▶ NEXT PAGE

▶ Steam Oxide is not recommended for Aluminum and Aluminum alloys.

◎ : Excellent ○ : Good

Low carbon steels/ Free machining carbon steels	Medium to high carbon steels/ Low alloyed steels	Steel castings & forgings / Heat-treatable alloy steels	Alloyed tool steels / Mold steels	Free machining stainless steels	Heat-and corrosionresistant stainless steels / Valve stainless steels	Stainless steel castings / Precipitation hardening stainless steels	Pure Aluminum/ Aluminum alloys			
◎	◎	◎	◎	◎	◎	◎	◎			
Aluminum alloy castings	Grey cast iron	Nodular cast iron / Chilled cast iron / Meehanite iron / Ductile iron	718 & 625 INCO / Waspalloy / Hastelloy / Invar / Monel / Incoloy	718 Inconel / A286	Titanium	Pure and alloyed copper	Free machining brass / Alloyed brass	Bronze	Zinc	Magnesium
◎	◎	◎	○	○	◎	◎	◎	◎	◎	◎

Y/G COMBO TAPS



T2/T2-S/T2-C SERIES

Y/G COMBO TAPS



T5/T5-S/T5-C SERIES

SPIRAL FLUTE TAPS for Multi-Purpose

SPIRAL FLUTE TAPS for Multi-Purpose

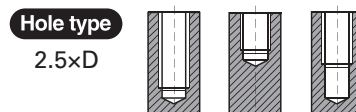
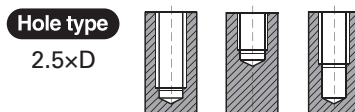
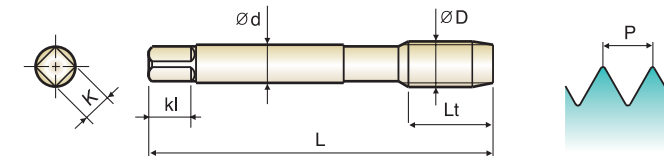
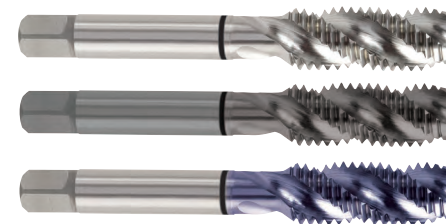
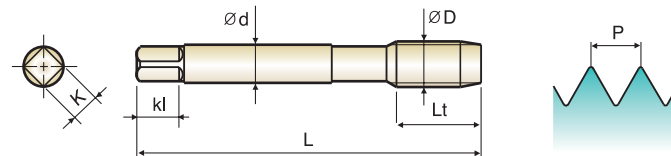

MU HSS-EX UNC UNF USCTI 302A H2-H6 60° 2P~3P Bright Steam Oxide TiCN R40

MU HSS-EX M USCTI 302A D3-D8 60° 2P~3P Bright Steam Oxide TiCN R40

Unit : Inch

EDP No.			SIZE & TPI	Limit	Overall Length L	Thread Length Lt	Shank Diameter D	Square Size K	Square Length kl	No. of Flute
Bright	Steam Oxide	TiCN								
T2483	T2483S	T2483C	3/8 - 16 UNC	H3	2.94	.551	.381	.286	.438	3
T2485	T2485S	T2485C	3/8 - 16 UNC	H5	2.94	.551	.381	.286	.438	3
T2503	T2503S	T2503C	3/8 - 24 UNF	H3	2.94	.394	.381	.286	.438	3
T2504	T2504S	T2504C	3/8 - 24 UNF	H4	2.94	.394	.381	.286	.438	3
T2523	T2523S	T2523C	7/16 - 14 UNC	H3	3.16	.591	.323	.242	.406	3
T2525	T2525S	T2525C	7/16 - 14 UNC	H5	3.16	.591	.323	.242	.406	3
T2543	T2543S	T2543C	7/16 - 20 UNF	H3	3.16	.472	.323	.242	.406	3
T2545	T2545S	T2545C	7/16 - 20 UNF	H5	3.16	.472	.323	.242	.406	3
T2565	T2565S	T2565C	1/2 - 13 UNC	H5	3.38	.630	.367	.275	.438	3
T2585	T2585S	T2585C	1/2 - 20 UNF	H5	3.38	.472	.367	.275	.438	3
T2605	T2605S	T2605C	9/16 - 12 UNC	H5	3.59	.709	.429	.322	.500	3
T2625	T2625S	T2625C	9/16 - 18 UNF	H5	3.59	.512	.429	.322	.500	3
T2645	T2645S	T2645C	5/8 - 11 UNC	H5	3.81	.748	.480	.360	.562	4
T2665	T2665S	T2665C	5/8 - 18 UNF	H5	3.81	.512	.480	.360	.562	4
T2705	T2705S	T2705C	3/4 - 10 UNC	H5	4.25	.827	.590	.442	.688	4
T2725	T2725S	T2725C	3/4 - 16 UNF	H5	4.25	.591	.590	.442	.688	4
T2746	T2746S	T2746C	7/8 - 9 UNC	H6	4.69	.827	.697	.523	.750	4
T2766	T2766S	T2766C	7/8 - 14 UNF	H6	4.69	.709	.697	.523	.750	4
T2786	T2786S	T2786C	1" - 8 UNC	H6	5.13	.984	.800	.600	.812	4
T2806	T2806S	T2806C	1" - 12 UNF	H6	5.13	.709	.800	.600	.812	4

▶ Coating(TiN, TiAlN or Hardslick) is available on your request.
 ▶ Coating Codes for Combo Tap
 Bright Finish No. + N(TiN), F(TiAlN), H(Hardslick)

Unit : Inch

EDP No.			SIZE & TPI	Limit	Overall Length L	Thread Length Lt	Shank Diameter D	Square Size K	Square Length kl	No. of Flute
Bright	Steam Oxide	TiCN								
T5203	T5203S	T5203C	M3 x 0.5	D3	1.94	.197	.141	.110	.188	3
T5224	T5224S	T5224C	M3.5 x 0.6	D4	2.00	.276	.141	.110	.188	3
T5244	T5244S	T5244C	M4 x 0.7	D4	2.13	.276	.168	.131	.250	3
T5284	T5284S	T5284C	M5 x 0.8	D4	2.38	.354	.194	.152	.250	3
T5315	T5315S	T5315C	M6 x 1.0	D5	2.50	.433	.255	.191	.312	3
T5345	T5345S	T5345C	M7 x 1.0	D5	2.72	.433	.318	.238	.375	3
T5365	T5365S	T5365C	M8 x 1.25	D5	2.72	.472	.318	.238	.375	3
T5375	T5375S	T5375C	M8 x 1.0	D5	2.72	.433	.318	.238	.375	3
T5426	T5426S	T5426C	M10 x 1.5	D6	2.94	.512	.381	.286	.438	3
T5435	T5435S	T5435C	M10 x 1.25	D5	2.94	.472	.381	.286	.438	3
T5506	T5506S	T5506C	M12 x 1.75	D6	3.38	.591	.367	.275	.438	3
T5525	T5525S	T5525C	M12 x 1.25	D5	3.38	.551	.367	.275	.438	3
T5547	T5547S	T5547C	M14 x 2.0	D7	3.59	.709	.429	.322	.500	3
T5556	T5556S	T5556C	M14 x 1.5	D6	3.59	.551	.429	.322	.500	3
T5607	T5607S	T5607C	M16 x 2.0	D7	3.81	.709	.480	.360	.562	3
T5616	T5616S	T5616C	M16 x 1.5	D6	3.81	.551	.480	.360	.562	3
T5657	T5657S	T5657C	M18 x .5	D7	4.03	.787	.542	.406	.625	4
T5676	T5676S	T5676C	M18 x 1.5	D6	4.03	.551	.542	.406	.625	4
T5707	T5707S	T5707C	M20 x 2.5	D7	4.47	.787	.652	.489	.688	4
T5726	T5726S	T5726C	M20 x 1.5	D6	4.47	.551	.652	.489	.688	4
T5747	T5747S	T5747C	M22 x 2.5	D7	4.69	.787	.697	.523	.750	4
T5766	T5766S	T5766C	M22 x 1.5	D6	4.69	.551	.697	.523	.750	4
T5788	T5788S	T5788C	M24 x 3.0	D8	4.91	.945	.760	.570	.750	4

▶ Coating(TiN, TiAlN or Hardslick) is available on your request.
 ▶ Coating Codes for Combo Tap
 Bright Finish No. + N(TiN), F(TiAlN), H(Hardslick)

▶ Steam Oxide is not recommended for Aluminum and Aluminum alloys. ◎ : Excellent ○ : Good

▶ Steam Oxide is not recommended for Aluminum and Aluminum alloys. ◎ : Excellent ○ : Good

Low carbon steels/ Free machining carbon steels	Medium to high carbon steels/ Low alloyed steels	Steel castings & forgings / Heat-treatable alloy steels	Alloyed tool steels / Mold steels	Free machining stainless steels	Heat-and corrosionresistant stainless steels / Valve stainless steels	Stainless steel castings / Precipitation hardening stainless steels	Pure Aluminum/ Aluminum alloys			
◎	◎	◎	◎	◎	◎	◎	◎			
Aluminum alloy castings	Grey cast iron	Nodular cast iron / Chilled cast iron / Meehanite iron / Ductile iron	718 & 625 INCO / Waspaloy / Hastelloy / Invar / Monel / Incoloy	718 Inconel / A286	Titanium	Pure and alloyed copper	Free machining brass / Alloyed brass	Bronze	Zinc	Magnesium
◎	◎	◎	○	○	◎	◎	◎	◎	◎	◎

Low carbon steels/ Free machining carbon steels	Medium to high carbon steels/ Low alloyed steels	Steel castings & forgings / Heat-treatable alloy steels	Alloyed tool steels / Mold steels	Free machining stainless steels	Heat-and corrosionresistant stainless steels / Valve stainless steels	Stainless steel castings / Precipitation hardening stainless steels	Pure Aluminum/ Aluminum alloys			
◎	◎	◎	◎	◎	◎	◎	◎			
Aluminum alloy castings	Grey cast iron	Nodular cast iron / Chilled cast iron / Meehanite iron / Ductile iron	718 & 625 INCO / Waspaloy / Hastelloy / Invar / Monel / Incoloy	718 Inconel / A286	Titanium	Pure and alloyed copper	Free machining brass / Alloyed brass	Bronze	Zinc	Magnesium
◎	◎	◎	○	○	◎	◎	◎	◎	◎	◎

Y/G COMBO TAPS



T6/T6-N SERIES

Y/G COMBO TAPS



T8/T8-N SERIES

SPIRAL FLUTE TAPS for Multi-Purpose

SPIRAL FLUTE TAPS for Multi-Purpose

with Internal Coolant

with Internal Coolant

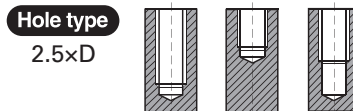
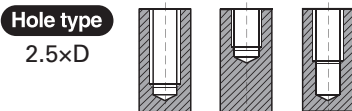
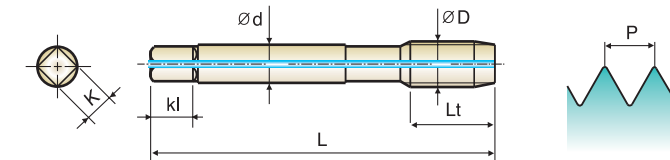
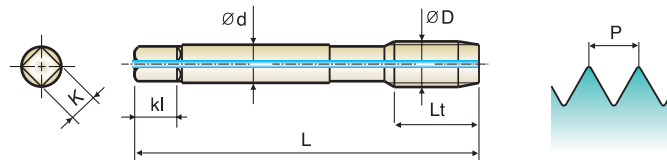

MU **HSS-EX** **UNC UNF** **USCTI 302A** **H4-H6** **60°** **2P~3P** **Bright** **TiN** **R40**

MU **HSS-EX** **M** **USCTI 302A** **D5-D7** **60°** **2P~3P** **Bright** **TiN** **R40**

Unit : Inch

EDP No.		SIZE & TPI	Limit	Overall Length L	Thread Length Lt	Shank Diameter D	Square Size K	Square Length kl	No. of Flute
Bright	TiN								
T6405	T6405N	1/4 - 20 UNC	H5	2.50	.433	.255	.191	.312	3
T6424	T6424N	1/4 - 28 UNF	H4	2.50	.354	.255	.191	.312	3
T6445	T6445N	5/16 - 18 UNC	H5	2.72	.472	.318	.238	.375	3
T6464	T6464N	5/16 - 24 UNF	H4	2.72	.394	.318	.238	.375	3
T6485	T6485N	3/8 - 16 UNC	H5	2.94	.551	.381	.286	.438	3
T6504	T6504N	3/8 - 24 UNF	H4	2.94	.394	.381	.286	.438	3
T6525	T6525N	7/16 - 14 UNC	H5	3.16	.591	.323	.242	.406	3
T6545	T6545N	7/16 - 20 UNF	H5	3.16	.472	.323	.242	.406	3
T6565	T6565N	1/2 - 13 UNC	H5	3.38	.630	.367	.275	.438	3
T6585	T6585N	1/2 - 20 UNF	H5	3.38	.472	.367	.275	.438	3
T6605	T6605N	9/16 - 12 UNC	H5	3.59	.709	.429	.322	.500	3
T6625	T6625N	9/16 - 18 UNF	H5	3.59	.512	.429	.322	.500	3
T6645	T6645N	5/8 - 11 UNC	H5	3.81	.748	.480	.360	.562	4
T6665	T6665N	5/8 - 18 UNF	H5	3.81	.512	.480	.360	.562	4
T6705	T6705N	3/4 - 10 UNC	H5	4.25	.827	.590	.442	.688	4
T6725	T6725N	3/4 - 16 UNF	H5	4.25	.591	.590	.442	.688	4
T6746	T6746N	7/8 - 9 UNC	H6	4.69	.827	.697	.523	.750	4
T6766	T6766N	7/8 - 14 UNF	H6	4.69	.709	.697	.523	.750	4
T6786	T6786N	1" - 8 UNC	H6	5.13	.984	.800	.600	.812	4
T6806	T6806N	1" - 12 UNF	H6	5.13	.709	.800	.600	.812	4

Unit : Inch

EDP No.		SIZE & TPI	Limit	Overall Length L	Thread Length Lt	Shank Diameter D	Square Size K	Square Length kl	No. of Flute
Bright	TiN								
T8315	T8315N	M6 x 1.0	D5	2.50	.433	.255	.191	.312	3
T8365	T8365N	M8 x 1.25	D5	2.72	.472	.318	.238	.375	3
T8426	T8426N	M10 x 1.5	D6	2.94	.512	.381	.286	.438	3
T8506	T8506N	M12 x 1.75	D6	3.38	.591	.367	.275	.438	3
T8547	T8547N	M14 x 2.0	D7	3.59	.709	.429	.322	.500	3
T8607	T8607N	M16 x 2.0	D7	3.81	.709	.480	.360	.562	3
T8657	T8657N	M18 x 2.5	D7	4.03	.787	.542	.406	.625	4
T8707	T8707N	M20 x 2.5	D7	4.47	.787	.652	.489	.688	4

► Coating(TiCN, TiAlN or Hardslick) or Surface Treatment(Steam Oxide) is available on your request.
Coating Codes for Combo Tap
Bright Finish No. + C(TiCN), F(TiAlN), H(Hardslick), S(Steam Oxide)

► Coating(TiCN, TiAlN or Hardslick) or Surface Treatment(Steam Oxide) is available on your request.
Coating Codes for Combo Tap
Bright Finish No. + C(TiCN), F(TiAlN), H(Hardslick), S(Steam Oxide)

◎ : Excellent ○ : Good

Low carbon steels/ Free machining carbon steels	Medium to high carbon steels/ Low alloyed steels	Steel castings & forgings / Heat-treatable alloy steels	Alloyed tool steels / Mold steels	Free machining stainless steels	Heat-and corrosionresistant stainless steels / Valve stainless steels	Stainless steel castings / Precipitation hardening stainless steels	Pure Aluminum/ Aluminum alloys			
◎	◎	◎	◎	◎	◎	◎	◎			
Aluminum alloy castings	Grey cast iron	Nodular cast iron / Chilled cast iron / Meehanite iron / Ductile iron	718 & 625 INCO / Waspaloy / Hastelloy / Invar / Monel / Incoloy	718 Inconel / A286	Titanium	Pure and alloyed copper	Free machining brass / Alloyed brass	Bronze	Zinc	Magnesium
◎	◎	◎	○	○	◎	◎	◎	◎	◎	◎

◎ : Excellent ○ : Good

Low carbon steels/ Free machining carbon steels	Medium to high carbon steels/ Low alloyed steels	Steel castings & forgings / Heat-treatable alloy steels	Alloyed tool steels / Mold steels	Free machining stainless steels	Heat-and corrosionresistant stainless steels / Valve stainless steels	Stainless steel castings / Precipitation hardening stainless steels	Pure Aluminum/ Aluminum alloys			
◎	◎	◎	◎	◎	◎	◎	◎			
Aluminum alloy castings	Grey cast iron	Nodular cast iron / Chilled cast iron / Meehanite iron / Ductile iron	718 & 625 INCO / Waspaloy / Hastelloy / Invar / Monel / Incoloy	718 Inconel / A286	Titanium	Pure and alloyed copper	Free machining brass / Alloyed brass	Bronze	Zinc	Magnesium
◎	◎	◎	○	○	◎	◎	◎	◎	◎	◎



T7/T7-C SERIES



T7/T7-C SERIES

SPIRAL FLUTE TAPS for Multi-Purpose

SPIRAL FLUTE TAPS for Multi-Purpose

Short Chamfer

Short Chamfer

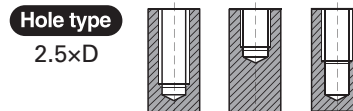
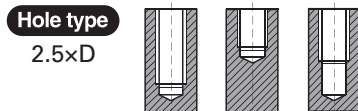
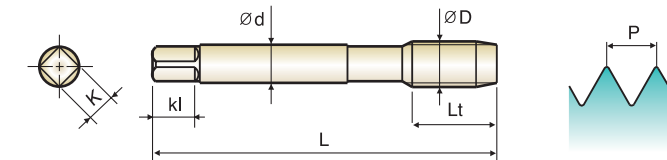
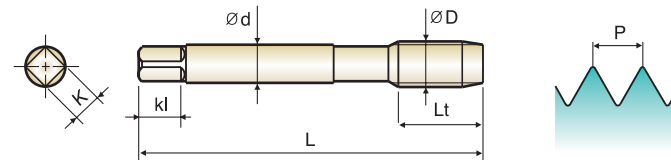
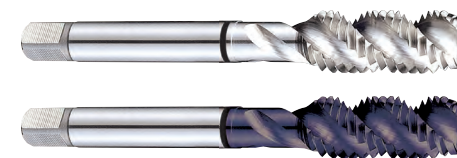
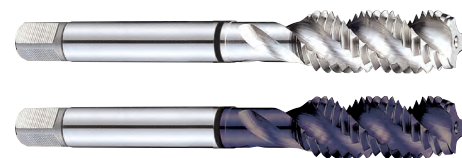

MU HSS-EX UNC UNF USCTI 302A H2-H6 60° 1P~2P Bright TiCN R40

MU HSS-EX UNC UNF USCTI 302A H2-H6 60° 1P~2P Bright TiCN R40

Unit : Inch

EDP No.		SIZE & TPI	Limit	Overall Length L	Thread Length Lt	Shank Diameter D	Square Size K	Square Length kl	No. of Flute
Bright	TiCN								
T7162	T7162C	#4 - 40 UNC	H2	1.88	.236	.141	.110	.188	2
T7182	T7182C	#4 - 48 UNF	H2	1.88	.236	.141	.110	.188	2
T7202	T7202C	#5 - 40 UNC	H2	1.94	.236	.141	.110	.188	3
T7222	T7222C	#5 - 44 UNF	H2	1.94	.236	.141	.110	.188	3
T7243	T7243C	#6 - 32 UNC	H3	2.00	.276	.141	.110	.188	3
T7262	T7262C	#6 - 40 UNF	H2	2.00	.276	.141	.110	.188	3
T7283	T7283C	#8 - 32 UNC	H3	2.13	.276	.168	.131	.250	3
T7302	T7302C	#8 - 36 UNF	H2	2.13	.276	.168	.131	.250	3
T7323	T7323C	#10 - 24 UNC	H3	2.38	.354	.194	.152	.250	3
T7343	T7343C	#10 - 32 UNF	H3	2.38	.276	.194	.152	.250	3
T7363	T7363C	#12 - 24 UNC	H3	2.38	.354	.220	.165	.281	3
T7383	T7383C	#12 - 28 UNF	H3	2.38	.276	.220	.165	.281	3
T7405	T7405C	1/4 - 20 UNC	H5	2.50	.433	.255	.191	.312	3
T7424	T7424C	1/4 - 28 UNF	H4	2.50	.354	.255	.191	.312	3
T7445	T7445C	5/16 - 18 UNC	H5	2.72	.472	.318	.238	.375	3
T7464	T7464C	5/16 - 24 UNF	H4	2.72	.394	.318	.238	.375	3
T7485	T7485C	3/8 - 16 UNC	H5	2.94	.551	.381	.286	.438	3
T7504	T7504C	3/8 - 24 UNF	H4	2.94	.394	.381	.286	.438	3
T7525	T7525C	7/16 - 14 UNC	H5	3.16	.591	.323	.242	.406	3
T7545	T7545C	7/16 - 20 UNF	H5	3.16	.472	.323	.242	.406	3
T7565	T7565C	1/2 - 13 UNC	H5	3.38	.630	.367	.275	.438	3
T7585	T7585C	1/2 - 20 UNF	H5	3.38	.472	.367	.275	.438	3

Unit : Inch

EDP No.		SIZE & TPI	Limit	Overall Length L	Thread Length Lt	Shank Diameter D	Square Size K	Square Length kl	No. of Flute
Bright	TiCN								
T7605	T7605C	9/16 - 12 UNC	H5	3.59	.709	.429	.322	.500	3
T7625	T7625C	9/16 - 18 UNF	H5	3.59	.512	.429	.322	.500	3
T7645	T7645C	5/8 - 11 UNC	H5	3.81	.748	.480	.360	.562	4
T7665	T7665C	5/8 - 18 UNF	H5	3.81	.512	.480	.360	.562	4
T7705	T7705C	3/4 - 10 UNC	H5	4.25	.827	.590	.442	.688	4
T7725	T7725C	3/4 - 16 UNF	H5	4.25	.591	.590	.442	.688	4
T7746	T7746C	7/8 - 9 UNC	H6	4.69	.827	.697	.523	.750	4
T7766	T7766C	7/8 - 14 UNF	H6	4.69	.709	.697	.523	.750	4
T7786	T7786C	1" - 8 UNC	H6	5.13	.984	.800	.600	.812	4
T7806	T7806C	1" - 12 UNF	H6	5.13	.709	.800	.600	.812	4

► Coating(TiN, TiAlN or Hardslick) or Surface Treatment(Steam Oxide) is available on your request.
Coating Codes for Combo Tap
Bright Finish No. + N(TiN), F(TiAlN), H(Hardslick), S(Steam Oxide)

► Coating(TiN, TiAlN or Hardslick) or Surface Treatment(Steam Oxide) is available on your request.
Coating Codes for Combo Tap
Bright Finish No. + N(TiN), F(TiAlN), H(Hardslick), S(Steam Oxide)

► NEXT PAGE

◎ : Excellent ○ : Good

Low carbon steels/ Free machining carbon steels	Medium to high carbon steels/ Low alloyed steels	Steel castings & forgings / Heat-treatable alloy steels	Alloyed tool steels / Mold steels	Free machining stainless steels	Heat-and corrosionresistant stainless steels / Valve stainless steels	Stainless steel castings / Precipitation hardening stainless steels	Pure Aluminum/ Aluminum alloys				
◎	◎	◎	◎	◎	◎	◎	◎				
Aluminum alloy castings	Grey cast iron	Nodular cast iron / Chilled cast iron / Meehanite iron / Ductile iron	718 & 625 INCO / Waspaloy / Hastelloy / Invar / Monel / Incoloy	718 Inconel / A286	Titanium	Pure and alloyed copper	Free machining brass / Alloyed brass	Bronze	Zinc	Magnesium	
◎	◎	◎	○		○	◎	◎	◎	◎	◎	

◎ : Excellent ○ : Good

Low carbon steels/ Free machining carbon steels	Medium to high carbon steels/ Low alloyed steels	Steel castings & forgings / Heat-treatable alloy steels	Alloyed tool steels / Mold steels	Free machining stainless steels	Heat-and corrosionresistant stainless steels / Valve stainless steels	Stainless steel castings / Precipitation hardening stainless steels	Pure Aluminum/ Aluminum alloys				
◎	◎	◎	◎	◎	◎	◎	◎				
Aluminum alloy castings	Grey cast iron	Nodular cast iron / Chilled cast iron / Meehanite iron / Ductile iron	718 & 625 INCO / Waspaloy / Hastelloy / Invar / Monel / Incoloy	718 Inconel / A286	Titanium	Pure and alloyed copper	Free machining brass / Alloyed brass	Bronze	Zinc	Magnesium	
◎	◎	◎	○		○	◎	◎	◎	◎	◎	



T9/T9-C SERIES



T1-S/T1-C SERIES

SPIRAL FLUTE TAPS for Multi-Purpose

SPIRAL FLUTE TAPS for Multi-Purpose

Short Chamfer

DIN-ANSI Shank

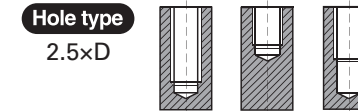
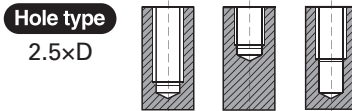
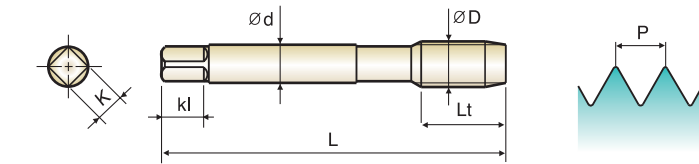
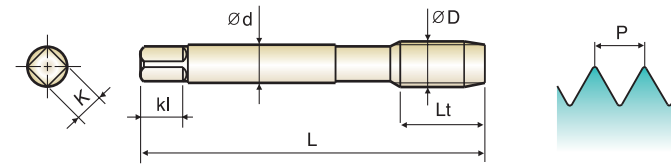
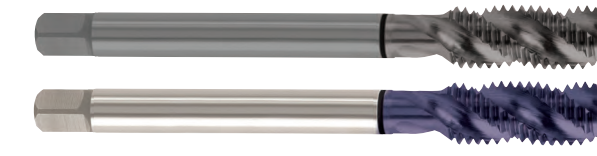
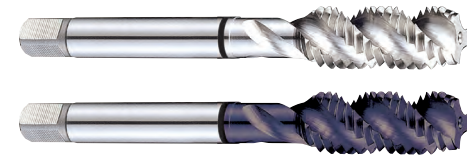

MU HSS-EX M USCTI 302A D3-D8 60° 1P~2P Bright TiCN R40

MU HSS-EX UNC UNF H2-H6 60° 2P~3P Steam Oxide TiCN R40

Unit : Inch

EDP No.		SIZE & TPI	Limit	Overall Length L	Thread Length L _t	Shank Diameter D	Square Size K	Square Length kl	No. of Flute
Bright	TiCN								
T9203	T9203C	M3 x 0.5	D3	1.94	.197	.141	.110	.188	3
T9224	T9224C	M3.5 x 0.6	D4	2.00	.276	.141	.110	.188	3
T9244	T9244C	M4 x 0.7	D4	2.13	.276	.168	.131	.250	3
T9284	T9284C	M5 x 0.8	D4	2.38	.354	.194	.152	.250	3
T9315	T9315C	M6 x 1.0	D5	2.50	.433	.255	.191	.312	3
T9345	T9345C	M7 x 1.0	D5	2.72	.433	.318	.238	.375	3
T9365	T9365C	M8 x 1.2	D5	2.72	.472	.318	.238	.375	3
T9375	T9375C	M8 x 1.0	D5	2.72	.433	.318	.238	.375	3
T9426	T9426C	M10 x 1.5	D6	2.94	.512	.381	.286	.438	3
T9435	T9435C	M10 x 1.25	D5	2.94	.472	.381	.286	.438	3
T9506	T9506C	M12 x 1.75	D6	3.38	.591	.367	.275	.438	3
T9525	T9525C	M12 x 1.25	D5	3.38	.551	.367	.275	.438	3
T9547	T9547C	M14 x 2.0	D7	3.59	.709	.429	.322	.500	3
T9556	T9556C	M14 x 1.5	D6	3.59	.551	.429	.322	.500	3
T9607	T9607C	M16 x 2.0	D7	3.81	.709	.480	.360	.562	3
T9616	T9616C	M16 x 1.5	D6	3.81	.551	.480	.360	.562	3
T9657	T9657C	M18 x 2.5	D7	4.03	.787	.542	.406	.625	4
T9676	T9676C	M18 x 1.5	D6	4.03	.551	.542	.406	.625	4
T9707	T9707C	M20 x 2.5	D7	4.47	.787	.652	.489	.688	4
T9726	T9726C	M20 x 1.5	D6	4.47	.551	.652	.489	.688	4
T9747	T9747C	M22 x 2.5	D7	4.69	.787	.697	.523	.750	4
T9766	T9766C	M22 x 1.5	D6	4.69	.551	.697	.523	.750	4
T9788	T9788C	M24 x 3.0	D8	4.91	.945	.760	.570	.750	4

Unit : Inch

EDP No.		SIZE & TPI	Limit	Overall Length L	Thread Length L _t	Shank Diameter D	Square Size K	Square Length kl	No. of Flute
Steam Oxide	TiCN								
T1162S	T1162C	#4 - 40 UNC	H2	2.21	.236	.141	.110	.188	2
T1202S	T1202C	#5 - 40 UNC	H2	2.21	.236	.141	.110	.188	3
T1243S	T1243C	#6 - 32 UNC	H3	2.21	.276	.141	.110	.188	3
T1283S	T1283C	#8 - 32 UNC	H3	2.48	.276	.168	.131	.250	3
T1323S	T1323C	#10 - 24 UNC	H3	2.76	.354	.194	.152	.250	3
T1343S	T1343C	#10 - 32 UNF	H3	2.76	.276	.194	.152	.250	3
T1363S	T1363C	#12 - 24 UNC	H3	3.15	.354	.220	.165	.281	3
T1383S	T1383C	#12 - 28 UNF	H3	3.15	.276	.220	.165	.281	3
T1405S	T1405C	1/4 - 20 UNC	H5	3.15	.433	.255	.191	.312	3
T1424S	T1424C	1/4 - 28 UNF	H4	3.15	.354	.255	.191	.312	3
T1445S	T1445C	5/16 - 18 UNC	H5	3.54	.472	.318	.238	.375	3
T1464S	T1464C	5/16 - 24 UNF	H4	3.54	.394	.318	.238	.375	3
T1485S	T1485C	3/8 - 16 UNC	H5	3.94	.551	.381	.286	.438	3
T1504S	T1504C	3/8 - 24 UNF	H4	3.94	.394	.381	.286	.438	3
T1525S	T1525C	7/16 - 14 UNC	H5	3.94	.591	.323	.242	.406	3
T1545S	T1545C	7/16 - 20 UNF	H5	3.94	.472	.323	.242	.406	3
T1565S	T1565C	1/2 - 13 UNC	H5	4.33	.630	.367	.275	.438	3
T1585S	T1585C	1/2 - 20 UNF	H5	3.94	.472	.367	.275	.438	3
T1605S	T1605C	9/16 - 12 UNC	H5	4.33	.709	.429	.322	.500	3
T1625S	T1625C	9/16 - 18 UNF	H5	3.94	.512	.429	.322	.500	3
T1645S	T1645C	5/8 - 11 UNC	H5	4.33	.748	.480	.360	.562	4
T1665S	T1665C	5/8 - 18 UNF	H5	3.94	.512	.480	.360	.562	4
T1705S	T1705C	3/4 - 10 UNC	H5	4.92	.827	.590	.442	.688	4
T1725S	T1725C	3/4 - 16 UNF	H5	4.33	.591	.590	.442	.688	4
T1746S	T1746C	7/8 - 9 UNC	H6	5.51	.827	.697	.523	.750	4
T1766S	T1766C	7/8 - 14 UNF	H6	4.92	.709	.697	.523	.750	4
T1786S	T1786C	1" - 8 UNC	H6	6.30	.984	.800	.600	.812	4
T1806S	T1806C	1" - 12 UNF	H6	5.51	.709	.800	.600	.812	4

► Coating(TiN, TiAlN or Hardslick) or Surface Treatment(Steam Oxide) is available on your request.
Coating Codes for Combo Tap
Bright Finish No. + N(TiN), F(TiAlN), H(Hardslick), S(Steam Oxide)

► Steam Oxide is not recommended for Aluminum and Aluminum alloys.

◎ : Excellent ○ : Good

Low carbon steels/ Free machining carbon steels	Medium to high carbon steels/ Low alloyed steels	Steel castings & forgings / Heat-treatable alloy steels	Alloyed tool steels / Mold steels	Free machining stainless steels	Heat-and corrosionresistant stainless steels / Valve stainless steels	Stainless steel castings / Precipitation hardening stainless steels	Pure Aluminum/ Aluminum alloys			
◎	◎	◎	◎	◎	◎	◎	◎			
Aluminum alloy castings	Grey cast iron	Nodular cast iron / Chilled cast iron / Meehanite iron / Ductile iron	718 & 625 INCO / Waspaloy / Hastelloy / Invar / Monel / Incoloy	718 Inconel / A286	Titanium	Pure and alloyed copper	Free machining brass / Alloyed brass	Bronze	Zinc	Magnesium
◎	◎	◎	○	○	◎	◎	◎	◎	◎	◎

◎ : Excellent ○ : Good

Low carbon steels/ Free machining carbon steels	Medium to high carbon steels/ Low alloyed steels	Steel castings & forgings / Heat-treatable alloy steels	Alloyed tool steels / Mold steels	Free machining stainless steels	Heat-and corrosionresistant stainless steels / Valve stainless steels	Stainless steel castings / Precipitation hardening stainless steels	Pure Aluminum/ Aluminum alloys			
◎	◎	◎	◎	◎	◎	◎	◎			
Aluminum alloy castings	Grey cast iron	Nodular cast iron / Chilled cast iron / Meehanite iron / Ductile iron	718 & 625 INCO / Waspaloy / Hastelloy / Invar / Monel / Incoloy	718 Inconel / A286	Titanium	Pure and alloyed copper	Free machining brass / Alloyed brass	Bronze	Zinc	Magnesium
◎	◎	◎	○	○	◎	◎	◎	◎	◎	◎

Y/G COMBO TAPS



TA-S/TA-C SERIES

Y/G COMBO TAPS



TCA-S/TCB-S/TCA-C/TCB-C SERIES

SPIRAL FLUTE TAPS for Multi-Purpose

SPIRAL FLUTE TAPS for Stainless Steels

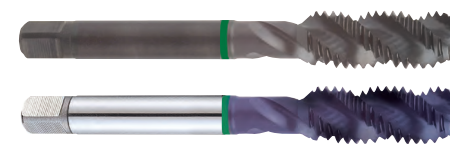
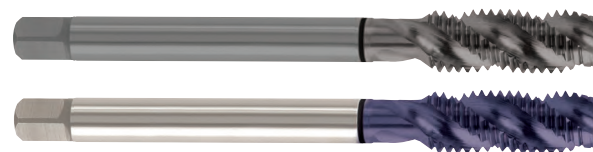

DIN-ANSI Shank

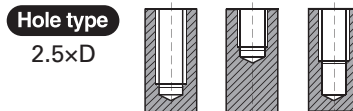
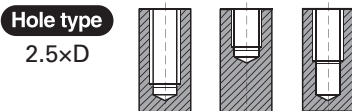
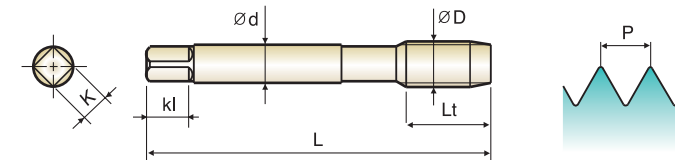
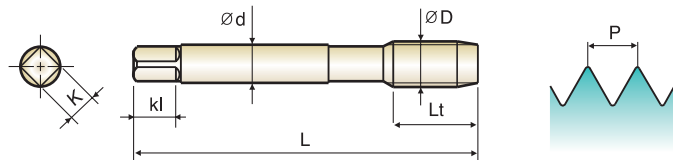

MU **HSS-EX** **M** **D3-D7** **60°** **2P~3P** **Steam Oxide** **TiCN** **R40**

VA **Super HSS** **HSS-EX** **UNC UNF** **USCTI 302A** **H2-H6** **60°** **2P~3P** **Steam Oxide** **TiCN** **R45**

Unit : Inch

Unit : Inch

EDP No.		SIZE & TPI	Limit	Overall Length L	Thread Length Lt	Shank Diameter D	Square Size K	Square Length kl	No. of Flute
Steam Oxide	TiCN								
TA203S	TA203C	M3 x 0.5	D3	2.21	.197	.141	.110	.188	3
TA224S	TA224C	M3.5 x 0.6	D4	2.21	.276	.141	.110	.188	3
TA244S	TA244C	M4 x 0.7	D4	2.48	.276	.168	.131	.250	3
TA284S	TA284C	M5 x 0.8	D4	2.76	.354	.194	.152	.250	3
TA315S	TA315C	M6 x 1.0	D5	3.15	.433	.255	.191	.312	3
TA365S	TA365C	M8 x 1.25	D5	3.54	.472	.318	.238	.375	3
TA426S	TA426C	M10 x 1.5	D6	3.94	.512	.381	.286	.438	3
TA435S	TA435C	M10 x 1.25	D5	3.94	.472	.381	.286	.438	3
TA506S	TA506C	M12 x 1.75	D6	4.33	.591	.367	.275	.438	3
TA525S	TA525C	M12 x 1.25	D5	3.94	.551	.367	.275	.438	3
TA547S	TA547C	M14 x 2.0	D7	4.33	.709	.429	.322	.500	3
TA556S	TA556C	M14 x 1.5	D6	3.94	.551	.429	.322	.500	3
TA607S	TA607C	M16 x 2.0	D7	4.33	.709	.480	.360	.562	3
TA616S	TA616C	M16 x 1.5	D6	3.94	.551	.480	.360	.562	3
TA657S	TA657C	M18 x 2.5	D7	4.92	.787	.542	.406	.625	4
TA676S	TA676C	M18 x 1.5	D6	4.33	.551	.542	.406	.625	4

EDP No.		SIZE & TPI	Limit	Overall Length L	Thread Length Lt	Shank Diameter D	Square Size K	Square Length kl	No. of Flute
Steam Oxide	TiCN								
TCA202S	TCA202C	#5 - 40 UNC	H2	1.94	.236	.141	.110	.188	3
TCA243S	TCA243C	#6 - 32 UNC	H3	2.00	.276	.141	.110	.188	3
TCA283S	TCA283C	#8 - 32 UNC	H3	2.13	.276	.141	.131	.250	3
TCA323S	TCA323C	#10 - 24 UNC	H3	2.38	.354	.141	.152	.250	3
TCA343S	TCA343C	#10 - 32 UNF	H3	2.38	.276	.141	.152	.250	3
TCA403S	TCA403C	1/4 - 20 UNC	H3	2.50	.433	.141	.191	.312	3
TCA405S	TCA405C	1/4 - 20 UNC	H5	2.50	.433	.168	.191	.312	3
TCA423S	TCA423C	1/4 - 28 UNF	H3	2.50	.354	.168	.191	.312	3
TCA443S	TCA443C	5/16 - 18 UNC	H3	2.72	.472	.194	.238	.375	3
TCA445S	TCA445C	5/16 - 18 UNC	H5	2.72	.472	.194	.238	.375	3
TCA463S	TCA463C	5/16 - 24 UNF	H3	2.72	.394	.220	.238	.375	3
TCA483S	TCA483C	3/8 - 16 UNC	H3	2.94	.551	.220	.286	.438	3
TCA485S	TCA485C	3/8 - 16 UNC	H5	2.94	.551	.255	.286	.438	3
TCA503S	TCA503C	3/8 - 24 UNF	H3	2.94	.394	.255	.286	.438	3
TCA523S	TCA523C	7/16 - 14 UNC	H3	3.16	.591	.255	.242	.406	3
TCA525S	TCA525C	7/16 - 14 UNC	H5	3.16	.591	.255	.242	.406	3
TCA543S	TCA543C	7/16 - 20 UNF	H3	3.16	.472	.318	.242	.406	3
TCA545S	TCA545C	7/16 - 20 UNF	H5	3.16	.472	.318	.242	.406	3
TCA563S	TCA563C	1/2 - 13 UNC	H3	3.38	.630	.318	.275	.438	3
TCA565S	TCA565C	1/2 - 13 UNC	H5	3.38	.630	.318	.275	.438	3
TCA583S	TCA583C	1/2 - 20 UNF	H3	3.38	.472	.381	.275	.438	3
TCB603S	TCB603C	9/16 - 12 UNC	H3	3.59	.709	.381	.322	.500	3
TCB623S	TCB623C	9/16 - 18 UNF	H3	3.59	.512	.381	.322	.500	3
TCB625S	TCB625C	9/16 - 18 UNF	H5	3.59	.512	.381	.322	.500	3
TCB643S	TCB643C	5/8 - 11 UNC	H3	3.81	.748	.323	.360	.562	4
TCB645S	TCB645C	5/8 - 11 UNC	H5	3.81	.748	.323	.360	.562	4
TCB663S	TCB663C	5/8 - 18 UNF	H3	3.81	.512	.323	.360	.562	4

► Steam Oxide is not recommended for Aluminum and Aluminum alloys.

◎ : Excellent ○ : Good

Low carbon steels/ Free machining carbon steels	Medium to high carbon steels/ Low alloyed steels	Steel castings & forgings / Heat-treatable alloy steels	Alloyed tool steels / Mold steels	Free machining stainless steels	Heat-and corrosionresistant stainless steels / Valve stainless steels	Stainless steel castings / Precipitation hardening stainless steels	Pure Aluminum/ Aluminum alloys				
◎	◎	◎	◎	◎	◎	◎	◎				
Aluminum alloy castings	Grey cast iron	Nodular cast iron / Chilled cast iron / Meehanite iron / Ductile iron	718 & 625 INCO / Waspaloy / Hastelloy / Invar / Monel / Incoloy	718 Inconel / A286	Titanium	Pure and alloyed copper	Free machining brass / Alloyed brass	Bronze	Zinc	Magnesium	
◎	◎	◎	○		○	◎	◎	◎	◎	◎	

► Super HSS(#5~1/2) and HSS-EX(9/16~1")

► NEXT PAGE

◎ : Excellent ○ : Good

Low carbon steels/ Free machining carbon steels	Medium to high carbon steels/ Low alloyed steels	Steel castings & forgings / Heat-treatable alloy steels	Alloyed tool steels / Mold steels	Free machining stainless steels	Heat-and corrosionresistant stainless steels / Valve stainless steels	Stainless steel castings / Precipitation hardening stainless steels	Pure Aluminum/ Aluminum alloys				
○	○			◎							
Aluminum alloy castings	Grey cast iron	Nodular cast iron / Chilled cast iron / Meehanite iron / Ductile iron	718 & 625 INCO / Waspaloy / Hastelloy / Invar / Monel / Incoloy	718 Inconel / A286	Titanium	Pure and alloyed copper	Free machining brass / Alloyed brass	Bronze	Zinc	Magnesium	

Y/G COMBO TAPS



TCA-S/TCB-S/TCA-C/TCB-C SERIES

Y/G COMBO TAPS



TCC-S/TCD-S/TCC-C/TCD-C SERIES

SPIRAL FLUTE TAPS for Stainless Steels

SPIRAL FLUTE TAPS for Stainless Steels

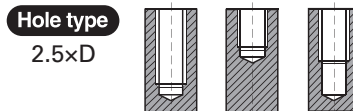
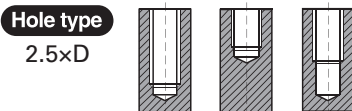
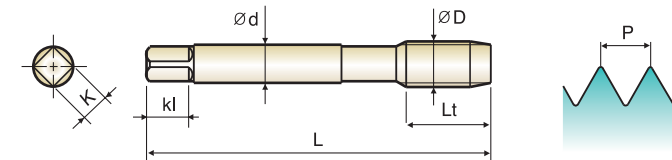
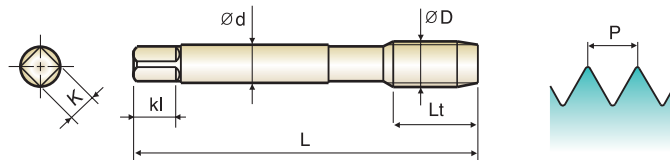
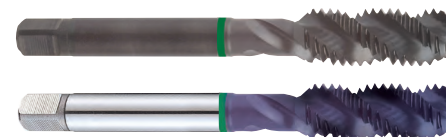

VA Super HSS HSS-EX UNC UNF USCTI 302A H2-H6 60° 2P~3P Steam Oxide TiCN R45

VA Super HSS HSS-EX M USCTI 302A D3-D7 60° 2P~3P Steam Oxide TiCN R45

Unit : Inch

Unit : Inch

EDP No.		SIZE & TPI	Limit	Overall Length L	Thread Length Lt	Shank Diameter D	Square Size K	Square Length kl	No. of Flute
Steam Oxide	TiCN								
TCB665S	TCB665C	5/8 - 18 UNF	H5	3.81	.512	.323	.360	.562	4
TCB703S	TCB703C	3/4 - 10 UNC	H3	4.25	.827	.367	.442	.688	4
TCB705S	TCB705C	3/4 - 10 UNC	H5	4.25	.827	.367	.442	.688	4
TCB723S	TCB723C	3/4 - 16 UNF	H3	4.25	.591	.429	.442	.688	4
TCB725S	TCB725C	3/4 - 16 UNF	H5	4.25	.591	.429	.442	.688	4
TCB744S	TCB744C	7/8 - 9 UNC	H4	4.69	.827	.480	.523	.750	4
TCB746S	TCB746C	7/8 - 9 UNC	H6	4.69	.827	.480	.523	.750	4
TCB764S	TCB764C	7/8 - 14 UNF	H4	4.69	.709	.590	.523	.750	4
TCB766S	TCB766C	7/8 - 14 UNF	H6	4.69	.709	.590	.523	.750	4
TCB784S	TCB784C	1" - 8 UNC	H4	5.13	.984	.697	.600	.812	4
TCB786S	TCB786C	1" - 8 UNC	H6	5.13	.984	.697	.600	.812	4
TCB804S	TCB804C	1" - 12 UNF	H4	5.13	.709	.800	.600	.812	4
TCB806S	TCB806C	1" - 12 UNF	H6	5.13	.709	.800	.600	.812	4

► Super HSS(#5~1/2) and HSS-EX(9/16~1")

EDP No.		SIZE & TPI	Limit	Overall Length L	Thread Length Lt	Shank Diameter D	Square Size K	Square Length kl	No. of Flute
Steam Oxide	TiCN								
TCC203S	TCC203C	M3 x 0.5	D3	1.94	.197	.141	.110	.188	3
TCC224S	TCC224C	M3.5 x 0.6	D4	2.00	.276	.141	.110	.188	3
TCC244S	TCC244C	M4 x 0.7	D4	2.13	.276	.168	.131	.250	3
TCC284S	TCC284C	M5 x 0.8	D4	2.38	.354	.194	.152	.250	3
TCC315S	TCC315C	M6 x 1.0	D5	2.50	.433	.255	.191	.312	3
TCC345S	TCC345C	M7 x 1.0	D5	2.72	.433	.318	.238	.375	3
TCC365S	TCC365C	M8 x 1.25	D5	2.72	.472	.318	.238	.375	3
TCC375S	TCC375C	M8 x 1.0	D5	2.72	.433	.318	.238	.375	3
TCC426S	TCC426C	M10 x 1.5	D6	2.94	.512	.381	.286	.438	3
TCC435S	TCC435C	M10 x 1.25	D5	2.94	.472	.381	.286	.438	3
TCC506S	TCC506C	M12 x 1.75	D6	3.38	.591	.367	.275	.438	3
TCC525S	TCC525C	M12 x 1.25	D5	3.38	.551	.367	.275	.438	3
TCD547S	TCD547C	M14 x 2.0	D7	3.59	.709	.429	.322	.500	3
TCD556S	TCD556C	M14 x 1.5	D6	3.59	.551	.429	.322	.500	3
TCD607S	TCD607C	M16 x 2.0	D7	3.81	.709	.480	.360	.562	3
TCD616S	TCD616C	M16 x 1.5	D6	3.81	.551	.480	.360	.562	3
TCD657S	TCD657C	M18 x 2.5	D7	4.03	.787	.542	.406	.625	4
TCD676S	TCD676C	M18 x 1.5	D6	4.03	.551	.542	.406	.625	4

► Super HSS(M3-M12) and HSS-EX(M14-M18)

◎ : Excellent ○ : Good

◎ : Excellent ○ : Good

Low carbon steels/ Free machining carbon steels	Medium to high carbon steels/ Low alloyed steels	Steel castings & forgings / Heat-treatable alloy steels	Alloyed tool steels / Mold steels	Free machining stainless steels	Heat-and corrosionresistant stainless steels / Valve stainless steels	Stainless steel castings / Precipitation hardening stainless steels	Pure Aluminum/ Aluminum alloys				
○	○			◎							
Aluminum alloy castings	Grey cast iron	Nodular cast iron / Chilled cast iron / Meehanite iron / Ductile iron	718 & 625 INCO / Waspaloy / Hastelloy / Invar / Monel / Incoloy	718 Inconel / A286	Titanium	Pure and alloyed copper	Free machining brass / Alloyed brass	Bronze	Zinc	Magnesium	

Low carbon steels/ Free machining carbon steels	Medium to high carbon steels/ Low alloyed steels	Steel castings & forgings / Heat-treatable alloy steels	Alloyed tool steels / Mold steels	Free machining stainless steels	Heat-and corrosionresistant stainless steels / Valve stainless steels	Stainless steel castings / Precipitation hardening stainless steels	Pure Aluminum/ Aluminum alloys				
○	○			◎							
Aluminum alloy castings	Grey cast iron	Nodular cast iron / Chilled cast iron / Meehanite iron / Ductile iron	718 & 625 INCO / Waspaloy / Hastelloy / Invar / Monel / Incoloy	718 Inconel / A286	Titanium	Pure and alloyed copper	Free machining brass / Alloyed brass	Bronze	Zinc	Magnesium	



T4/T4-S/T4-C SERIES



T4/T4-S/T4-C SERIES

SPIRAL POINT TAPS for Multi-Purpose

SPIRAL POINT TAPS for Multi-Purpose

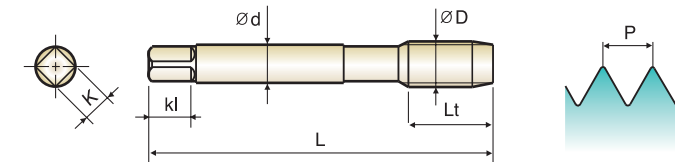
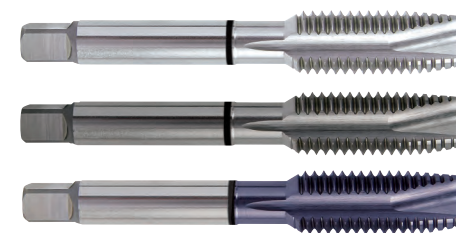
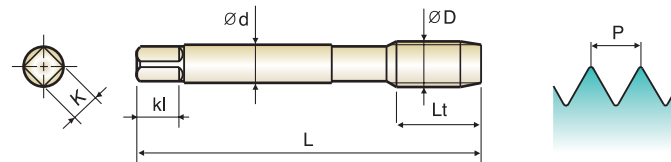
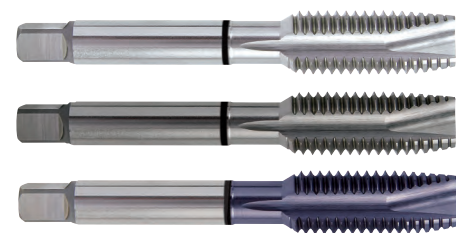

Hole type 3.0xD

Hole type 3.0xD

MU HSS-EX UNC UNF USCTI 302A H2-H6 60° 4P-5P Bright Steam Oxide TiCN

MU HSS-EX UNC UNF USCTI 302A H2-H6 60° 4P-5P Bright Steam Oxide TiCN

Unit : Inch

Unit : Inch

EDP No.			SIZE & TPI	Limit	Overall Length L	Thread Length Lt	Shank Diameter D	Square Size K	Square Length kl	No. of Flute
Bright	Steam Oxide	TiCN								
T4162	T4162S	T4162C	#4 - 40 UNC	H2	1.88	.335	.141	.110	.188	2
T4182	T4182S	T4182C	#4 - 48 UNF	H2	1.88	.335	.141	.110	.188	2
T4202	T4202S	T4202C	#5 - 40 UNC	H2	1.94	.374	.141	.110	.188	3
T4222	T4222S	T4222C	#5 - 44 UNF	H2	1.94	.374	.141	.110	.188	3
T4243	T4243S	T4243C	#6 - 32 UNC	H3	2.00	.413	.141	.110	.188	3
T4262	T4262S	T4262C	#6 - 40 UNF	H2	2.00	.413	.141	.110	.188	3
T4283	T4283S	T4283C	#8 - 32 UNC	H3	2.13	.453	.168	.131	.250	3
T4302	T4302S	T4302C	#8 - 36 UNF	H2	2.13	.453	.168	.131	.250	3
T4323	T4323S	T4323C	#10 - 24 UNC	H3	2.38	.531	.194	.152	.250	3
T4343	T4343S	T4343C	#10 - 24 UNF	H3	2.38	.531	.194	.152	.250	3
T4363	T4363S	T4363C	#12 - 24 UNC	H3	2.38	.571	.220	.165	.281	3
T4383	T4383S	T4383C	#12 - 28 UNF	H3	2.38	.571	.220	.165	.281	3
T4403	T4403S	T4403C	1/4 - 20 UNC	H3	2.50	.591	.255	.191	.312	3
T4405	T4405S	T4405C	1/4 - 20 UNC	H5	2.50	.591	.255	.191	.312	3
T4423	T4423S	T4423C	1/4 - 28 UNF	H3	2.50	.591	.255	.191	.312	3
T4424	T4424S	T4424C	1/4 - 28 UNF	H4	2.50	.591	.255	.191	.312	3
T4443	T4443S	T4443C	5/16 - 18 UNC	H3	2.72	.669	.318	.238	.375	3
T4445	T4445S	T4445C	5/16 - 18 UNC	H5	2.72	.669	.318	.238	.375	3
T4463	T4463S	T4463C	5/16 - 24 UNF	H3	2.72	.669	.318	.238	.375	3
T4465	T4465S	T4465C	5/16 - 24 UNF	H5	2.72	.669	.318	.238	.375	3
T4483	T4483S	T4483C	3/8 - 16 UNC	H3	2.94	.748	.381	.286	.438	3
T4485	T4485S	T4485C	3/8 - 16 UNC	H5	2.94	.748	.381	.286	.438	3
T4503	T4503S	T4503C	3/8 - 24 UNF	H3	2.94	.748	.381	.286	.438	3
T4504	T4504S	T4504C	3/8 - 24 UNF	H4	2.94	.748	.381	.286	.438	3
T4523	T4523S	T4523C	7/16 - 14 UNC	H3	3.16	.866	.323	.242	.406	3
T4525	T4525S	T4525C	7/16 - 14 UNC	H5	3.16	.866	.323	.242	.406	3

EDP No.			SIZE & TPI	Limit	Overall Length L	Thread Length Lt	Shank Diameter D	Square Size K	Square Length kl	No. of Flute
Bright	Steam Oxide	TiCN								
T4543	T4543S	T4543C	7/16 - 20 UNF	H3	3.16	.866	.323	.242	.406	3
T4545	T4545S	T4545C	7/16 - 20 UNF	H5	3.16	.866	.323	.242	.406	3
T4565	T4565S	T4565C	1/2 - 13 UNC	H5	3.38	.984	.367	.275	.438	3
T4585	T4585S	T4585C	1/2 - 20 UNF	H5	3.38	.984	.367	.275	.438	3
T4605	T4605S	T4605C	9/16 - 12 UNC	H5	3.59	.984	.429	.322	.500	3
T4625	T4625S	T4625C	9/16 - 18 UNF	H5	3.59	.984	.429	.322	.500	3
T4645	T4645S	T4645C	5/8 - 11 UNC	H5	3.81	1.083	.480	.360	.562	3
T4665	T4665S	T4665C	5/8 - 18 UNF	H5	3.81	1.083	.480	.360	.562	3
T4705	T4705S	T4705C	3/4 - 10 UNC	H5	4.25	1.201	.590	.442	.688	3
T4725	T4725S	T4725C	3/4 - 16 UNF	H5	4.25	1.201	.590	.442	.688	3
T4746	T4746S	T4746C	7/8 - 9 UNC	H6	4.69	1.339	.697	.523	.750	3
T4766	T4766S	T4766C	7/8 - 14 UNF	H6	4.69	1.339	.697	.523	.750	3
T4786	T4786S	T4786C	1" - 8 UNC	H6	5.13	1.496	.800	.600	.812	3
T4806	T4806S	T4806C	1" - 12 UNF	H6	5.13	1.496	.800	.600	.812	3

► Coating(TiN, TiAlN or Hardslick) is available on your request.
Coating Codes for Combo Tap
Bright Finish No. + N(TiN), F(TiAlN), H(Hardslick)

► NEXT PAGE

► Steam Oxide is not recommended for Aluminum and Aluminum alloys.

◎ : Excellent ○ : Good

Low carbon steels/ Free machining carbon steels	Medium to high carbon steels/ Low alloyed steels	Steel castings & forgings / Heat-treatable alloy steels	Alloyed tool steels / Mold steels	Free machining stainless steels	Heat-and corrosionresistant stainless steels / Valve stainless steels	Stainless steel castings / Precipitation hardening stainless steels	Pure Aluminum/ Aluminum alloys			
◎	◎	◎	◎	◎	◎	◎	◎			
Aluminum alloy castings	Grey cast iron	Nodular cast iron / Chilled cast iron / Meehanite iron / Ductile iron	718 & 625 INCO / Waspaloy / Hastelloy / Invar / Monel / Incoloy	718 Inconel / A286	Titanium	Pure and alloyed copper	Free machining brass / Alloyed brass	Bronze	Zinc	Magnesium
◎	◎	◎	○	○	◎	◎	◎	◎	◎	◎

► Coating(TiN, TiAlN or Hardslick) is available on your request.
Coating Codes for Combo Tap
Bright Finish No. + N(TiN), F(TiAlN), H(Hardslick)

► Steam Oxide is not recommended for Aluminum and Aluminum alloys.

◎ : Excellent ○ : Good

Low carbon steels/ Free machining carbon steels	Medium to high carbon steels/ Low alloyed steels	Steel castings & forgings / Heat-treatable alloy steels	Alloyed tool steels / Mold steels	Free machining stainless steels	Heat-and corrosionresistant stainless steels / Valve stainless steels	Stainless steel castings / Precipitation hardening stainless steels	Pure Aluminum/ Aluminum alloys			
◎	◎	◎	◎	◎	◎	◎	◎			
Aluminum alloy castings	Grey cast iron	Nodular cast iron / Chilled cast iron / Meehanite iron / Ductile iron	718 & 625 INCO / Waspaloy / Hastelloy / Invar / Monel / Incoloy	718 Inconel / A286	Titanium	Pure and alloyed copper	Free machining brass / Alloyed brass	Bronze	Zinc	Magnesium
◎	◎	◎	○	○	◎	◎	◎	◎	◎	◎



T3/T3-S/T3-C SERIES

SPIRAL POINT TAPS for Multi-Purpose

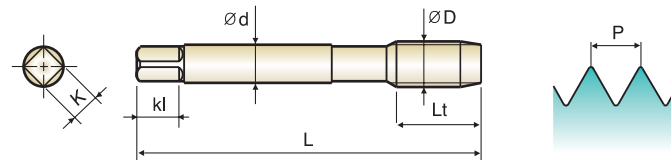

Hole type 3.0xD

MU HSS-EX M USCTI 302A D3-D8 60° 4P-5P Bright Steam Oxide TiCN

Unit : Inch

EDP No.		Limit	SIZE & TPI	Overall Length L	Thread Length Lt	Shank Diameter D	Square Size K	Square Length kl	No. of Flute
Bright	Steam Oxide								
T3203	T3203S	D3	M3 x 0.5	1.94	.374	.141	.110	.188	3
T3224	T3224S	D4	M3.5 x 0.6	2.00	.413	.141	.110	.188	3
T3244	T3244S	D4	M4 x 0.7	2.13	.453	.168	.131	.250	3
T3284	T3284S	D4	M5 x 0.8	2.38	.531	.194	.152	.250	3
T3315	T3315S	D5	M6 x 1.0	2.50	.591	.255	.191	.312	3
T3345	T3345S	D5	M7 x 1.0	2.72	.669	.318	.238	.375	3
T3365	T3365S	D5	M8 x 1.25	2.72	.669	.318	.238	.375	3
T3375	T3375S	D5	M8 x 1.0	2.72	.669	.318	.238	.375	3
T3426	T3426S	D6	M10 x 1.5	2.94	.748	.381	.286	.438	3
T3435	T3435S	D5	M10 x 1.25	2.94	.748	.381	.286	.438	3
T3506	T3506S	D6	M12 x 1.75	3.38	.984	.367	.275	.438	3
T3525	T3525S	D5	M12 x 1.25	3.38	.984	.367	.275	.438	3
T3547	T3547S	D7	M14 x 2.0	3.59	.984	.429	.322	.500	3
T3556	T3556S	D6	M14 x 1.5	3.59	.984	.429	.322	.500	3
T3607	T3607S	D7	M16 x 2.0	3.81	1.083	.480	.360	.562	3
T3616	T3616S	D6	M16 x 1.5	3.81	1.083	.480	.360	.562	3
T3657	T3657S	D7	M18 x 2.5	4.03	1.083	.542	.406	.625	3
T3676	T3676S	D6	M18 x 1.5	4.03	1.083	.542	.406	.625	3
T3707	T3707S	D7	M20 x 2.5	4.47	1.201	.652	.489	.688	3
T3726	T3726S	D6	M20 x 1.5	4.47	1.201	.652	.489	.688	3
T3747	T3747S	D7	M22 x 2.5	4.69	1.339	.697	.523	.750	3
T3766	T3766S	D6	M22 x 1.5	4.69	1.339	.697	.523	.750	3
T3788	T3788S	D8	M24 x 3.0	4.91	1.339	.760	.570	.750	3

► Coating(TiN, TiAlN or Hardslick) is available on your request. Coating Codes for Combo Tap Bright Finish No. + N(TiN), F(TiAlN), H(Hardslick), S(Steam Oxide)

► Steam Oxide is not recommended for Aluminum and Aluminum alloys.

◎ : Excellent ○ : Good

Low carbon steels/Free machining carbon steels	Medium to high carbon steels/Low alloyed steels	Steel castings & forgings/Heat-treatable alloy steels	Alloyed tool steels/Mold steels	Free machining stainless steels	Heat-and corrosionresistant stainless steels/Valve stainless steels	Stainless steel castings/Precipitation hardening stainless steels	Pure Aluminum/Aluminum alloys			
◎	◎	◎	◎	◎	◎	◎	◎			
Aluminum alloy castings	Grey cast iron	Nodular cast iron/Chilled cast iron/Meehanite iron/Ductile iron	718 & 625 INCO/Waspaloy/Hastelloy/Invar/Monel/Incoloy	718 Inconel/A286	Titanium	Pure and alloyed copper	Free machining brass/Alloyed brass	Bronze	Zinc	Magnesium
◎	◎	◎	○	○	◎	◎	◎	◎	◎	◎



TB/TB-N SERIES

SPIRAL POINT TAPS for Multi-Purpose



with Internal Coolant

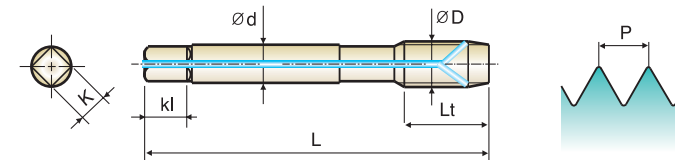

Hole type 3.0xD

MU HSS-EX UNC UNF USCTI 302A H4-H6 60° 4P-5P Bright TiN

Unit : Inch

EDP No.		Limit	SIZE & TPI	Overall Length L	Thread Length Lt	Shank Diameter D	Square Size K	Square Length kl	No. of Flute
Bright	TiN								
TB405	TB405N	H5	1/4 - 20 UNC	2.50	.591	.255	.191	.312	2
TB424	TB424N	H4	1/4 - 28 UNF	2.50	.591	.255	.191	.312	2
TB445	TB445N	H5	5/16 - 18 UNC	2.72	.669	.318	.238	.375	3
TB464	TB464N	H4	5/16 - 24 UNF	2.72	.669	.318	.238	.375	3
TB485	TB485N	H5	3/8 - 16 UNC	2.94	.748	.381	.286	.438	3
TB504	TB504N	H4	3/8 - 24 UNF	2.94	.748	.381	.286	.438	3
TB525	TB525N	H5	7/16 - 14 UNC	3.16	.866	.323	.242	.406	3
TB545	TB545N	H5	7/16 - 20 UNF	3.16	.866	.323	.242	.406	3
TB565	TB565N	H5	1/2 - 13 UNC	3.38	.984	.367	.275	.438	3
TB585	TB585N	H5	1/2 - 20 UNF	3.38	.984	.367	.275	.438	3
TB605	TB605N	H5	9/16 - 12 UNC	3.59	.984	.429	.322	.500	3
TB625	TB625N	H5	9/16 - 18 UNF	3.59	.984	.429	.322	.500	3
TB645	TB645N	H5	5/8 - 11 UNC	3.81	1.083	.480	.360	.562	3
TB665	TB665N	H5	5/8 - 18 UNF	3.81	1.083	.480	.360	.562	3
TB705	TB705N	H5	3/4 - 10 UNC	4.25	1.201	.590	.442	.688	3
TB725	TB725N	H5	3/4 - 16 UNF	4.25	1.201	.590	.442	.688	3
TB746	TB746N	H6	7/8 - 9 UNC	4.69	1.339	.697	.523	.750	3
TB766	TB766N	H6	7/8 - 14 UNF	4.69	1.339	.697	.523	.750	3
TB786	TB786N	H6	1" - 8 UNC	5.13	1.496	.800	.600	.812	3
TB806	TB806N	H6	1" - 12 UNF	5.13	1.496	.800	.600	.812	3

► Coating(TiCN, TiAlN or Hardslick) or Surface Treatment(Steam Oxide) is available on your request. Coating Codes for Combo Tap Bright Finish No. + C(TiCN), F(TiAlN), H(Hardslick), S(Steam Oxide)

◎ : Excellent ○ : Good

Low carbon steels/Free machining carbon steels	Medium to high carbon steels/Low alloyed steels	Steel castings & forgings/Heat-treatable alloy steels	Alloyed tool steels/Mold steels	Free machining stainless steels	Heat-and corrosionresistant stainless steels/Valve stainless steels	Stainless steel castings/Precipitation hardening stainless steels	Pure Aluminum/Aluminum alloys			
◎	◎	◎	◎	◎	◎	◎	◎			
Aluminum alloy castings	Grey cast iron	Nodular cast iron/Chilled cast iron/Meehanite iron/Ductile iron	718 & 625 INCO/Waspaloy/Hastelloy/Invar/Monel/Incoloy	718 Inconel/A286	Titanium	Pure and alloyed copper	Free machining brass/Alloyed brass	Bronze	Zinc	Magnesium
◎	◎	◎	○	○	◎	◎	◎	◎	◎	◎

Y/G COMBO TAPS



TH/TH-N SERIES

Y/G COMBO TAPS



TC-S/TC-C SERIES

SPIRAL POINT TAPS for Multi-Purpose

SPIRAL POINT TAPS for Multi-Purpose

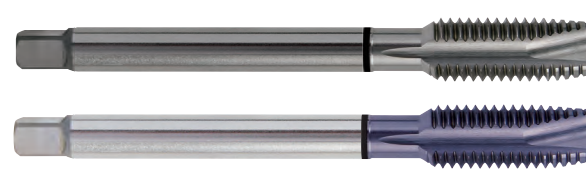

with Internal Coolant

DIN-ANSI Shank

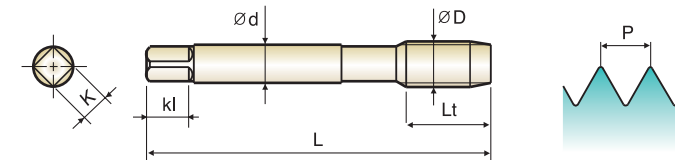
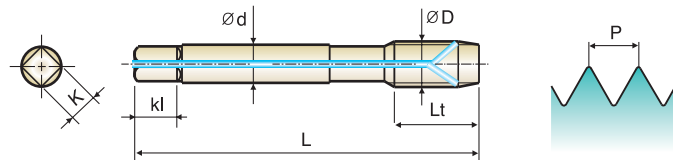

Hole type 3.0xD

Hole type 3.0xD

MU HSS-EX M USCTI 302A D5-D7 60° 4P-5P Bright TiN

MU HSS-EX UNC UNF H2-H6 60° 4P-5P Steam Oxide TiCN

Unit : Inch

Unit : Inch

EDP No.		SIZE & TPI	Limit	Overall Length L	Thread Length Lt	Shank Diameter D	Square Size K	Square Length kl	No. of Flute
Bright	TiN								
TH315	TH315N	M6 x 1.0	D5	2.50	.591	.255	.191	.312	3
TH365	TH365N	M8 x 1.25	D5	2.72	.669	.318	.238	.375	3
TH426	TH426N	M10 x 1.5	D6	2.94	.748	.381	.286	.438	3
TH506	TH506N	M12 x 1.75	D6	3.38	.984	.367	.275	.438	3
TH547	TH547N	M14 x 2.0	D7	3.59	.984	.429	.322	.500	3
TH607	TH607N	M16 x 2.0	D7	3.81	1.083	.480	.360	.562	3
TH657	TH657N	M18 x 2.5	D7	4.03	1.083	.542	.406	.625	3
TH707	TH707N	M20 x 2.5	D7	4.47	1.201	.652	.489	.688	3

EDP No.		SIZE & TPI	Limit	Overall Length L	Thread Length Lt	Shank Diameter D	Square Size K	Square Length kl	No. of Flute
Steam Oxide	TiCN								
TC162S	TC162C	#4 - 40 UNC	H2	2.21	.335	.141	.110	.188	2
TC202S	TC202C	#5 - 40 UNC	H2	2.21	.374	.141	.110	.188	3
TC243S	TC243C	#6 - 32 UNC	H3	2.21	.413	.141	.110	.188	3
TC283S	TC283C	#8 - 32 UNC	H3	2.48	.453	.168	.131	.250	3
TC323S	TC323C	#10 - 24 UNC	H3	2.76	.531	.194	.152	.250	3
TC343S	TC343C	#10 - 32 UNF	H3	2.76	.531	.194	.152	.250	3
TC363S	TC363C	#12 - 24 UNC	H3	3.15	.571	.220	.165	.281	3
TC383S	TC383C	#12 - 28 UNF	H3	3.15	.571	.220	.165	.281	3
TC405S	TC405C	1/4 - 20 UNC	H5	3.15	.591	.255	.191	.312	3
TC424S	TC424C	1/4 - 28 UNF	H4	3.15	.591	.255	.191	.312	3
TC445S	TC445C	5/16 - 18 UNC	H5	3.54	.669	.318	.238	.375	3
TC464S	TC464C	5/16 - 24 UNF	H4	3.54	.669	.318	.238	.375	3
TC485S	TC485C	3/8 - 16 UNC	H5	3.94	.748	.381	.286	.438	3
TC504S	TC504C	3/8 - 24 UNF	H4	3.94	.748	.381	.286	.438	3
TC525S	TC525C	7/16 - 14 UNC	H5	3.94	.866	.323	.242	.406	3
TC545S	TC545C	7/16 - 20 UNF	H5	3.94	.866	.323	.242	.406	3
TC565S	TC565C	1/2 - 13 UNC	H5	4.33	.984	.367	.275	.438	3
TC585S	TC585C	1/2 - 20 UNF	H5	3.94	.984	.367	.275	.438	3
TC605S	TC605C	9/16 - 12 UNC	H5	4.33	.984	.429	.322	.500	3
TC625S	TC625C	9/16 - 18 UNF	H5	3.94	.984	.429	.322	.500	3
TC645S	TC645C	5/8 - 11 UNC	H5	4.33	1.083	.480	.360	.562	3
TC665S	TC665C	5/8 - 18 UNF	H5	3.94	1.083	.480	.360	.562	3
TC705S	TC705C	3/4 - 10 UNC	H5	4.92	1.201	.590	.442	.688	3
TC725S	TC725C	3/4 - 16 UNF	H5	4.33	1.201	.590	.442	.688	3
TC746S	TC746C	7/8 - 9 UNC	H6	5.51	1.339	.697	.523	.750	3
TC766S	TC766C	7/8 - 14 UNF	H6	4.92	1.339	.697	.523	.750	3
TC786S	TC786C	1" - 8 UNC	H6	6.30	1.496	.800	.600	.812	3
TC806S	TC806C	1" - 12 UNF	H6	5.51	1.496	.800	.600	.812	3

► Coating(TiCN, TiAlN or Hardslick) or Surface Treatment(Steam Oxide) is available on your request.
Coating Codes for Combo Tap
Bright Finish No. + C(TiCN), F(TiAlN), H(Hardslick), S(Steam Oxide)

► Steam Oxide is not recommended for Aluminum and Aluminum alloys.

◎ : Excellent ○ : Good

Low carbon steels/ Free machining carbon steels	Medium to high carbon steels/ Low alloyed steels	Steel castings & forgings / Heat-treatable alloy steels	Alloyed tool steels / Mold steels	Free machining stainless steels	Heat-and corrosionresistant stainless steels / Valve stainless steels	Stainless steel castings / Precipitation hardening stainless steels	Pure Aluminum/ Aluminum alloys			
◎	◎	◎	◎	◎	◎	◎	◎			
Aluminum alloy castings	Grey cast iron	Nodular cast iron / Chilled cast iron / Meehanite iron / Ductile iron	718 & 625 INCO / Waspaloy / Hastelloy / Invar / Monel / Incoloy	718 Inconel / A286	Titanium	Pure and alloyed copper	Free machining brass / Alloyed brass	Bronze	Zinc	Magnesium
◎	◎	◎	○	○	◎	◎	◎	◎	◎	◎

◎ : Excellent ○ : Good

Low carbon steels/ Free machining carbon steels	Medium to high carbon steels/ Low alloyed steels	Steel castings & forgings / Heat-treatable alloy steels	Alloyed tool steels / Mold steels	Free machining stainless steels	Heat-and corrosionresistant stainless steels / Valve stainless steels	Stainless steel castings / Precipitation hardening stainless steels	Pure Aluminum/ Aluminum alloys			
◎	◎	◎	◎	◎	◎	◎	◎			
Aluminum alloy castings	Grey cast iron	Nodular cast iron / Chilled cast iron / Meehanite iron / Ductile iron	718 & 625 INCO / Waspaloy / Hastelloy / Invar / Monel / Incoloy	718 Inconel / A286	Titanium	Pure and alloyed copper	Free machining brass / Alloyed brass	Bronze	Zinc	Magnesium
◎	◎	◎	○	○	◎	◎	◎	◎	◎	◎



TK-S/TK-C SERIES



TCE-S/TCF-S/TCE-C/TCF-C SERIES

SPIRAL POINT TAPS for Multi-Purpose

SPIRAL POINT TAPS for Stainless Steels

DIN-ANSI Shank

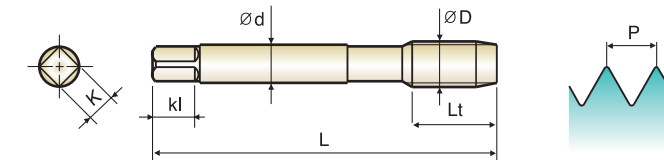
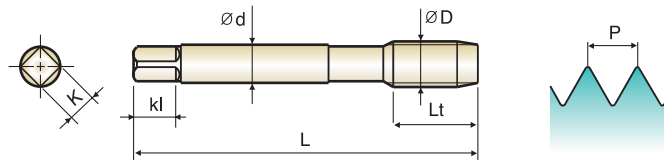
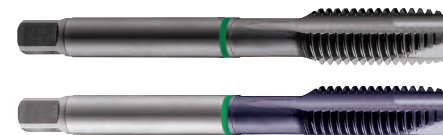
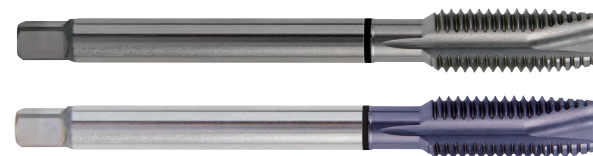

Hole type 3.0xD

Hole type 3.0xD

MU HSS-EX M D3-D7 60° 4P~5P Steam Oxide TiCN

VA Super HSS HSS-EX UNC UNF USCTI 302A H2-H6 60° 4P Steam Oxide TiCN

Unit : Inch

Unit : Inch

EDP No.		SIZE & TPI	Limit	Overall Length L	Thread Length Lt	Shank Diameter D	Square Size K	Square Length kl	No. of Flute
Steam Oxide	TiCN								
TK203S	TK203C	M3 x 0.5	D3	.374	.374	.141	.110	.188	3
TK224S	TK224C	M3.5 x 0.6	D4	.413	.413	.141	.110	.188	3
TK244S	TK244C	M4 x 0.7	D4	.453	.453	.168	.131	.250	3
TK284S	TK284C	M5 x 0.8	D4	.531	.531	.194	.152	.250	3
TK315S	TK315C	M6 x 1.0	D5	.591	.591	.255	.191	.312	3
TK365S	TK365C	M8 x 1.25	D5	.669	.669	.318	.238	.375	3
TK426S	TK426C	M10 x 1.5	D6	.748	.748	.381	.286	.438	3
TK435S	TK435C	M10 x 1.25	D5	.748	.748	.381	.286	.438	3
TK506S	TK506C	M12 x 1.75	D6	.984	.984	.367	.275	.438	3
TK525S	TK525C	M12 x 1.25	D5	.984	.984	.367	.275	.438	3
TK547S	TK547C	M14 x 2.0	D7	.984	.984	.429	.322	.500	3
TK556S	TK556C	M14 x 1.5	D6	.984	.984	.429	.322	.500	3
TK607S	TK607C	M16 x 2.0	D7	1.083	1.083	.480	.360	.562	3
TK616S	TK616C	M16 x 1.5	D6	1.083	1.083	.480	.360	.562	3
TK657S	TK657C	M18 x 2.5	D7	1.083	1.083	.542	.406	.625	3
TK676S	TK676C	M18 x 1.5	D6	1.083	1.083	.542	.406	.625	3

EDP No.		SIZE & TPI	Limit	Overall Length L	Thread Length Lt	Shank Diameter D	Square Size K	Square Length kl	No. of Flute
Steam Oxide	TiCN								
TCE202S	TCE202C	#5 - 40 UNC	H2	1.94	.374	.141	.110	.188	3
TCE203S	TCE203C	#5 - 40 UNC	H3	1.94	.374	.141	.110	.188	3
TCE243S	TCE243C	#6 - 32 UNC	H3	2.00	.413	.141	.110	.188	3
TCE283S	TCE283C	#8 - 32 UNC	H3	2.13	.453	.168	.131	.250	3
TCE323S	TCE323C	#10 - 24 UNC	H3	2.38	.531	.194	.152	.250	3
TCE343S	TCE343C	#10 - 32 UNF	H3	2.38	.531	.194	.152	.250	3
TCE403S	TCE403C	1/4 - 20 UNC	H3	2.50	.591	.255	.191	.312	3
TCE405S	TCE405C	1/4 - 20 UNC	H5	2.50	.591	.255	.191	.312	3
TCE423S	TCE423C	1/4 - 28 UNF	H3	2.50	.591	.255	.191	.312	3
TCE443S	TCE443C	5/16 - 18 UNC	H3	2.72	.669	.318	.238	.375	3
TCE445S	TCE445C	5/16 - 18 UNC	H5	2.72	.669	.318	.238	.375	3
TCE463S	TCE463C	5/16 - 24 UNF	H3	2.72	.669	.318	.238	.375	3
TCE483S	TCE483C	3/8 - 16 UNC	H3	2.94	.748	.381	.286	.438	3
TCE485S	TCE485C	3/8 - 16 UNC	H5	2.94	.748	.381	.286	.438	3
TCE503S	TCE503C	3/8 - 24 UNF	H3	2.94	.748	.381	.286	.438	3
TCE523S	TCE523C	7/16 - 14 UNC	H3	3.16	.866	.323	.242	.406	3
TCE525S	TCE525C	7/16 - 14 UNC	H5	3.16	.866	.323	.242	.406	3
TCE543S	TCE543C	7/16 - 20 UNF	H3	3.16	.866	.323	.242	.406	3
TCE545S	TCE545C	7/16 - 20 UNF	H5	3.16	.866	.323	.242	.406	3
TCE563S	TCE563C	1/2 - 13 UNC	H3	3.38	.984	.367	.275	.438	3
TCE565S	TCE565C	1/2 - 13 UNC	H5	3.38	.984	.367	.275	.438	3
TCE583S	TCE583C	1/2 - 20 UNF	H3	3.38	.984	.367	.275	.438	3
TCF603S	TCF603C	9/16 - 12 UNC	H3	3.59	.984	.429	.322	.500	3
TCF623S	TCF623C	9/16 - 18 UNF	H3	3.59	.984	.429	.322	.500	3
TCF643S	TCF643C	5/8 - 11 UNC	H3	3.81	1.083	.480	.360	.562	3
TCF645S	TCF645C	5/8 - 11 UNC	H5	3.81	1.083	.480	.360	.562	3

► Super HSS(#5~1/2) and HSS-EX(9/16~1")

► NEXT PAGE

► Steam Oxide is not recommended for Aluminum and Aluminum alloys.

◎ : Excellent ○ : Good

Low carbon steels/ Free machining carbon steels	Medium to high carbon steels/ Low alloyed steels	Steel castings & forgings / Heat-treatable alloy steels	Alloyed tool steels / Mold steels	Free machining stainless steels	Heat-and corrosionresistant stainless steels / Valve stainless steels	Stainless steel castings / Precipitation hardening stainless steels	Pure Aluminum/ Aluminum alloys				
◎	◎	◎	◎	◎	◎	◎	◎				
Aluminum alloy castings	Grey cast iron	Nodular cast iron / Chilled cast iron / Meehanite iron / Ductile iron	718 & 625 INCO / Waspaloy / Hastelloy / Invar / Monel / Incoloy	718 Inconel / A286	Titanium	Pure and alloyed copper	Free machining brass / Alloyed brass	Bronze	Zinc	Magnesium	
◎	◎	◎	○		○	◎	◎	◎	◎	◎	

◎ : Excellent ○ : Good

Low carbon steels/ Free machining carbon steels	Medium to high carbon steels/ Low alloyed steels	Steel castings & forgings / Heat-treatable alloy steels	Alloyed tool steels / Mold steels	Free machining stainless steels	Heat-and corrosionresistant stainless steels / Valve stainless steels	Stainless steel castings / Precipitation hardening stainless steels	Pure Aluminum/ Aluminum alloys				
○	○			◎							
Aluminum alloy castings	Grey cast iron	Nodular cast iron / Chilled cast iron / Meehanite iron / Ductile iron	718 & 625 INCO / Waspaloy / Hastelloy / Invar / Monel / Incoloy	718 Inconel / A286	Titanium	Pure and alloyed copper	Free machining brass / Alloyed brass	Bronze	Zinc	Magnesium	

Y/G COMBO TAPS



TCE-S/TCF-S/TCE-C/TCF-C SERIES

Y/G COMBO TAPS



TCG-S/TCH-S/TCG-C/TCH-C SERIES

SPIRAL POINT TAPS for Stainless Steels

SPIRAL POINT TAPS for Stainless Steels

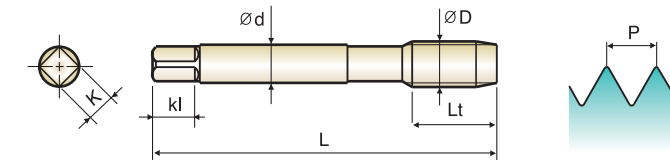
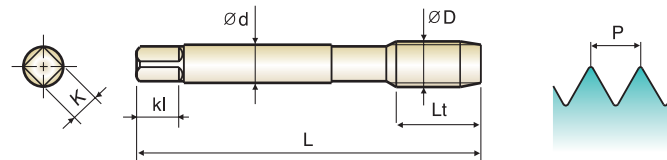
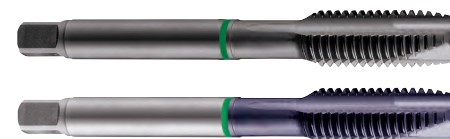
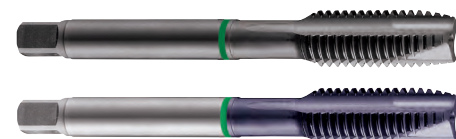

Hole type 3.0xD

Hole type 3.0xD

- VA
- Super HSS
- HSS-EX
- UNC UNF
- USCTI 302A
- H2-H6
- 60°
- 4P
- Steam Oxide
- TiCN

- VA
- Super HSS
- HSS-EX
- M
- USCTI 302A
- D3-D7
- 60°
- 4P
- Steam Oxide
- TiCN

Unit : Inch

Unit : Inch

EDP No.		SIZE & TPI	Limit	Overall Length L	Thread Length Lt	Shank Diameter D	Square Size K	Square Length kl	No. of Flute
Steam Oxide	TiCN								
TCF665S	TCF665C	5/8 - 18 UNF	H5	3.81	1.083	.480	.360	.562	3
TCF703S	TCF703C	3/4 - 10 UNC	H3	4.25	1.201	.590	.442	.688	3
TCF705S	TCF705C	3/4 - 10 UNC	H5	4.25	1.201	.590	.442	.688	3
TCF744S	TCF744C	7/8 - 9 UNC	H4	4.69	1.339	.697	.523	.750	3
TCF746S	TCF746C	7/8 - 9 UNC	H6	4.69	1.339	.697	.523	.750	3
TCF766S	TCF766C	7/8 - 14 UNF	H6	4.69	1.339	.697	.523	.750	3
TCF784S	TCF784C	1" - 8 UNC	H4	5.13	1.496	.800	.600	.812	3
TCF786S	TCF786C	1" - 8 UNC	H6	5.13	1.496	.800	.600	.812	3
TCF806S	TCF806C	1" - 12 UNF	H6	5.13	1.496	.800	.600	.812	3

► Super HSS(#5~1/2) and HSS-EX(9/16~1")

EDP No.		SIZE & TPI	Limit	Overall Length L	Thread Length Lt	Shank Diameter D	Square Size K	Square Length kl	No. of Flute
Steam Oxide	TiCN								
TCG203S	TCG203C	M3 x 0.5	D3	1.94	.374	.141	.110	.188	3
TCG224S	TCG224C	M3.5 x 0.6	D4	2.00	.413	.141	.110	.188	3
TCG244S	TCG244C	M4 x 0.7	D4	2.13	.453	.168	.131	.250	3
TCG284S	TCG284C	M5 x 0.8	D4	2.38	.531	.194	.152	.250	3
TCG315S	TCG315C	M6 x 1.0	D5	2.50	.591	.255	.191	.312	3
TCG345S	TCG345C	M7 x 1.0	D5	2.72	.669	.318	.238	.375	3
TCG365S	TCG365C	M8 x 1.25	D5	2.72	.669	.318	.238	.375	3
TCG375S	TCG375C	M8 x 1.0	D5	2.72	.669	.318	.238	.375	3
TCG426S	TCG426C	M10 x 1.5	D6	2.94	.748	.381	.286	.438	3
TCG435S	TCG435C	M10 x 1.25	D5	2.94	.748	.381	.286	.438	3
TCG506S	TCG506C	M12 x 1.75	D6	3.38	.984	.367	.275	.438	3
TCG525S	TCG525C	M12 x 1.25	D5	3.38	.984	.367	.275	.438	3
TCH547S	TCH547C	M14 x 2.0	D7	3.59	.984	.429	.322	.500	3
TCH556S	TCH556C	M14 x 1.5	D6	3.59	.984	.429	.322	.500	3
TCH607S	TCH607C	M16 x 2.0	D7	3.81	1.083	.480	.360	.562	3
TCH616S	TCH616C	M16 x 1.5	D6	3.81	1.083	.480	.360	.562	3
TCH657S	TCH657C	M18 x 2.5	D7	4.03	1.083	.542	.406	.625	3
TCH676S	TCH676C	M18 x 1.5	D6	4.03	1.083	.542	.406	.625	3

► Super HSS(M3-M12) and HSS-EX(M14-M18)

◎ : Excellent ○ : Good

◎ : Excellent ○ : Good

Low carbon steels/ Free machining carbon steels	Medium to high carbon steels/ Low alloyed steels	Steel castings & forgings / Heat-treatable alloy steels	Alloyed tool steels / Mold steels	Free machining stainless steels	Heat-and corrosionresistant stainless steels / Valve stainless steels	Stainless steel castings / Precipitation hardening stainless steels	Pure Aluminum/ Aluminum alloys				
○	○			◎							
Aluminum alloy castings	Grey cast iron	Nodular cast iron / Chilled cast iron / Meehanite iron / Ductile iron	718 & 625 INCO / Waspaloy / Hastelloy / Invar / Monel / Incoloy	718 Inconel / A286	Titanium	Pure and alloyed copper	Free machining brass / Alloyed brass	Bronze	Zinc	Magnesium	

Low carbon steels/ Free machining carbon steels	Medium to high carbon steels/ Low alloyed steels	Steel castings & forgings / Heat-treatable alloy steels	Alloyed tool steels / Mold steels	Free machining stainless steels	Heat-and corrosionresistant stainless steels / Valve stainless steels	Stainless steel castings / Precipitation hardening stainless steels	Pure Aluminum/ Aluminum alloys				
○	○			◎							
Aluminum alloy castings	Grey cast iron	Nodular cast iron / Chilled cast iron / Meehanite iron / Ductile iron	718 & 625 INCO / Waspaloy / Hastelloy / Invar / Monel / Incoloy	718 Inconel / A286	Titanium	Pure and alloyed copper	Free machining brass / Alloyed brass	Bronze	Zinc	Magnesium	

HSS

CARBIDE



COMBO TAPS

Combo TAP

SPIRAL FLUTE COMBO TAP SETS



TAP SETS SPIRAL FLUTE COMBO

Series	Series	Standard	Surface Treatment	Size	Q'ty
T2836SET8	T2	UNC/F	Bright	1/4-20, 1/4-28, 5/16-18, 5-16-24, 3/8-16, 3/8-24, 7/16-14, 7/16-20	8 pcs
TG836SET8	T2-C	UNC/F	TiCN	1/4-20, 1/4-28, 5/16-18, 5-16-24, 3/8-16, 3/8-24, 7/16-14, 7/16-20	8 pcs
T2836SET8 -1	T2	UNC/F	Bright	1/4-20, 1/4-28, 5/16-18, 5-16-24, 3/8-16, 3/8-24, 1/2-13, 1/2-20	8 pcs
TG836SET8 -1	T2-C	UNC/F	TiCN	1/4-20, 1/4-28, 5/16-18, 5-16-24, 3/8-16, 3/8-24, 1/2-13, 1/2-20	8 pcs
T2805SET7	T5	M	Bright	M3, M4, M5, M6, M8, M10, M12	7 pcs
TG805SET7	T5-C	M	TiCN	M3, M4, M5, M6, M8, M10, M12	7 pcs

* Hardslick Coated Set available upon request

HSS



Being the best through innovation



SPIRAL FLUTE TAPS



- Tapping Blind Holes / Super HSS, HSS-E, HSS-PM, HSS-V & HSS

SELECTION GUIDE

SPIRAL FLUTE TAPS

Tapping Blind Holes / Super HSS, HSS-E, HSS-PM, HSS-V & HSS

INCH

EDP No.	MODEL	Tool Material	Standard	Work Material	Dimensions	Tolerance	Chamfer	Thread Depth	Surface Treatment	Page
BB/BI		Super HSS	UNC/UNF	VG	USCTI 302A	H2~H6	2 ~ 3P	2.5D	Steam Oxide Hardslick	68
BH/BM		Super HSS	M/MF	VG	USCTI 302A	D3~D7	2 ~ 3P		Steam Oxide Hardslick	70
BF/BK		Super HSS	UNC/UNF	VG	DIN-ANSI Shank	H2~H6	2 ~ 3P		Steam Oxide Hardslick	71
BD/BO		Super HSS	M/MF	VG	DIN-ANSI Shank	D3~D7	2 ~ 3P		Steam Oxide Hardslick	72
H5/H7/H8		P-HSS	UNC/UNF	HR	USCTI 302A	H2~H5	2 ~ 3P		Steam Oxide TiCN Hardslick	73
TQ858/TK858/TR858		P-HSS	M/MF	HR	USCTI 302A	H2~H5	2 ~ 3P		Steam Oxide TiCN Hardslick	74
B3/B5/D6		P-HSS	UNC/UNF	Ti Ni	USCTI 302A	H2~H5	2 ~ 3P		Steam Oxide TiCN Hardslick	75
G9/H0		P-HSS	UNC/UNF	VA	USCTI Long Shank	H2~H3	2 ~ 3P		Hardslick	77
H2/H4		P-HSS	UNC/UNF	VA	USCTI Long Shank	H3	4 ~ 5P		3.0D TiN Hardslick	78
BG/BG-GB		HSSE-V3	UNC/UN8	VG	DIN-ANSI Shank	2B	2 ~ 3P		Hardslick Gold & Black	79
B1/B0/B2/D2		HSSE-V3	UNC/UNF	VA	USCTI 302A	H2~H7	2 ~ 3P	Bright Steam Oxide TiN/Hardslick	80	
BS/BT		HSSE-V3	M/MF	VA	USCTI 302A	D3~D7	2 ~ 3P	Steam Oxide Hardslick	83	
E6/E8/E9		HSSE-V3	M/MF	VA	DIN-ANSI Shank	D3~D7	2 ~ 3P	Steam Oxide TiCN Hardslick	84	
D3/E0		HSSE-V3	UNC/UNF	VG	USCTI 302A	H2~H11	2 ~ 3P	2.5D Hardslick Steam Oxide	85	
BU/BV		HSSE-V3	M/MF	VG	USCTI 302A	D3~D11	2 ~ 3P	Steam Oxide Hardslick	88	
E2/E4/E5		HSSE-V3	M/MF	VG	DIN-ANSI Shank	D3~D7	2 ~ 3P	Steam Oxide TiCN Hardslick	90	
C0/D8		HSSE-V3	UNC/UNF	AI	USCTI 302A	H2~H5	2 ~ 3P	Bright Hardslick	91	
BW/BX		HSSE-V3	M/MF	AI	USCTI 302A	D3~D6	2 ~ 3P	Bright Hardslick	92	

EDP No.	MODEL	Tool Material	Standard	Work Material	Dimensions	Tolerance	Chamfer	Thread Depth	Surface Treatment	Page
C2/C3/C4/D9		HSSE-V3	UNC/UNF	GS	USCTI 302	H2~H6	1.5 ~ 2P	2.5D	Steam Oxide Bright/TiN Hardslick	93
F4/F8/F6		HSS-V	UNC/UNF	GS	USCTI 302A	H2~H6	1.5 ~ 2P		Steam Oxide TiN Hardslick	94
G4/G5/G6		HSS-V	M/MF	GS	USCTI 302A	D3~D6	1.5 ~ 2P		Bright TiCN Hardslick	96
G0/G1/G2		HSS-V	UNC/UNF	GS	DIN-ANSI Shank	H2~H6	2 ~ 3P		Bright TiN Hardslick	97
T7A96/T6A96/T8A96		HSS	UNC/UNF	GS	USCTI 302	H2~H5	4 ~ 5P 1.5 ~ 2P		Bright Steam Oxide TiN	99
T7A86/T6A86/T8A86		HSS	M/MF	GS	USCTI 302	D3~D6	4 ~ 5P 1.5 ~ 2P		Bright Steam Oxide TiN	100
T7A85/T6A85/T8A85		HSS	M/MF	GS	USCTI 302	D3~D6	4 ~ 5P 1.5 ~ 2P		Bright Steam Oxide TiN	100
T7D01/T8D01/T7D02/T8D02		HSS	UNC/UNF	GS	USCTI Long Shank	H3	4 ~ 5P 1.5 ~ 2P		Bright TiN	101

SPIRAL FLUTE TAPS

BB/BI SERIES

SPIRAL FLUTE TAPS

BB/BI SERIES

SPIRAL FLUTE TAPS MODIFIED BOTTOMING STYLE for Steels & Stainless Steels up to 35HRc

SPIRAL FLUTE TAPS MODIFIED BOTTOMING STYLE for Steels & Stainless Steels up to 35HRc

Hole type 2.5xD

Hole type 2.5xD

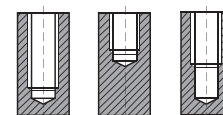
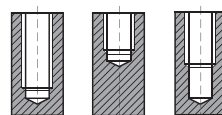

USCTI

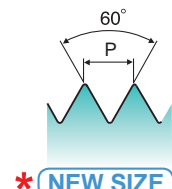

* NEW SIZE



USCTI

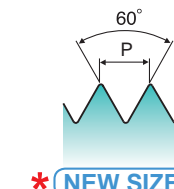

* NEW SIZE

VG Super HSS UNC UNF USCTI 302A H2-H6 60° 2P~3P Steam Oxide Hardslick R40

VG Super HSS UNC UNF USCTI 302A H2-H6 60° 2P~3P Steam Oxide Hardslick R40

EDP No.	Thread Per Inch		Limit	No. of Flute
	UNC	UNF		
BB082	2	56	H2	2
BB162	4	40	H2	2
* BB163	4	40	H3	2
* BB164	4	40	H4	2
BB202	5	40	H2	3
* BB242	6	32	H2	3
BB243	6	32	H3	3
* BB244	6	32	H4	3
* BB245	6	32	H5	3
* BB282	8	32	H2	3
BB283	8	32	H3	3
* BB284	8	32	H4	3
* BB285	8	32	H5	3
* BB286	8	32	H6	3
BB323	10	24	H3	3
* BB325	10	24	H5	3
* BB342	10	32	H2	3
BB343	10	32	H3	3
* BB344	10	32	H4	3
* BB345	10	32	H5	3
* BB346	10	32	H6	3
BB403	1/4	20	H3	3
BB405	1/4	20	H5	3
BB423	1/4	28	H3	3
BB424	1/4	28	H4	3
* BB425	1/4	28	H5	3
* BB426	1/4	28	H6	3
* BB443	5/16	18	H3	3
BB445	5/16	18	H5	3
* BB463	5/16	24	H3	3
BB464	5/16	24	H4	3
* BB465	5/16	24	H5	3
* BB466	5/16	24	H6	3

EDP No.	Thread Per Inch		Limit	No. of Flute
	UNC	UNF		
* BB483	3/8	16	H3	3
BB485	3/8	16	H5	3
* BB503	3/8	24	H3	3
BB504	3/8	24	H4	3
* BB505	3/8	24	H5	3
* BB506	3/8	24	H6	3
* BB523	7/16	14	H3	3
BB525	7/16	14	H5	3
* BB543	7/16	20	H3	3
BB545	7/16	20	H5	3
* BB563	1/2	13	H3	3
BB565	1/2	13	H5	3
* BB583	1/2	20	H3	3
BB585	1/2	20	H5	3
BB605	9/16	12	H5	3
BB625	9/16	18	H5	3
* BB643	5/8	11	H3	4
BB645	5/8	11	H5	4
* BB663	5/8	18	H3	4
BB665	5/8	18	H5	4
* BB703	3/4	10	H3	4
BB705	3/4	10	H5	4
* BB723	3/4	16	H3	4
BB725	3/4	16	H5	4
BB746	7/8	9	H6	4
BB766	7/8	14	H6	4
BB786	1	8	H6	4
BB806	1	12	H6	4
BB836	1-1/8	8	H6	4
BB876	1-1/4	8	H6	4
BB916	1-3/8	8	H6	4
BB956	1-1/2	8	H6	4

► For tapping depth on ANSI Length Taps, refer to MCTI 302 on page 197.

► For tapping depth on ANSI Length Taps, refer to MCTI 302 on page 197.

► NEXT PAGE

◎ : Excellent ○ : Good

◎ : Excellent ○ : Good

Low carbon steels / Free machining carbon steels	Medium to high carbon steels / Low alloyed steels	Steel castings & forgings / Heat-treatable alloy steels	Alloyed tool steels / Mold steels	Free machining stainless steels	Heat-and corrosionresistant stainless steels / Valve stainless steels	Stainless steel castings / Precipitation hardening stainless steels	Pure Aluminum / Aluminum alloys			
○	◎	◎		◎	◎		○			
Aluminum alloy castings	Grey cast iron	Nodular cast iron / Chilled cast iron / Meehanite iron / Ductile iron	718 & 625 INCO / Waspaloy / Hastelloy / Invar / Monel / Incoloy	718 Inconel / A286	Titanium	Pure and alloyed copper	Free machining brass / Alloyed brass	Bronze	Zinc	Magnesium
						○	○		○	○

Low carbon steels / Free machining carbon steels	Medium to high carbon steels / Low alloyed steels	Steel castings & forgings / Heat-treatable alloy steels	Alloyed tool steels / Mold steels	Free machining stainless steels	Heat-and corrosionresistant stainless steels / Valve stainless steels	Stainless steel castings / Precipitation hardening stainless steels	Pure Aluminum / Aluminum alloys			
○	◎	◎		◎	◎		○			
Aluminum alloy castings	Grey cast iron	Nodular cast iron / Chilled cast iron / Meehanite iron / Ductile iron	718 & 625 INCO / Waspaloy / Hastelloy / Invar / Monel / Incoloy	718 Inconel / A286	Titanium	Pure and alloyed copper	Free machining brass / Alloyed brass	Bronze	Zinc	Magnesium
						○	○		○	○

SPIRAL FLUTE TAPS

BH/BM SERIES

SPIRAL FLUTE TAPS MODIFIED BOTTOMING STYLE for Steels & Stainless Steels up to 35HRc

Hole type 2.5xD

USCTI

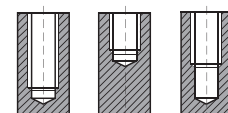
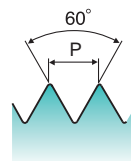

VG
Super HSS
M MF
USCTI 302A
D3~D7
60°
2P~3P
Steam Oxide
Hardslick
R40

EDP No.		SIZE	Pitch	Limit	No. of Flute
Steam Oxide	Hardslick				
BH203	BM203	M3	0.5	D3	3
BH224	BM224	M3.5	0.6	D4	3
BH244	BM244	M4	0.7	D4	3
BH284	BM284	M5	0.8	D4	3
BH315	BM315	M6	1.0	D5	3
BH345	BM345	M7	1.0	D5	3
BH365	BM365	M8	1.25	D5	3
BH375	BM375	M8	1.0	D5	3
BH426	BM426	M10	1.5	D6	3
BH435	BM435	M10	1.25	D5	3
BH506	BM506	M12	1.75	D6	3
BH525	BM525	M12	1.25	D5	3
BH547	BM547	M14	2.0	D7	3
BH556	BM556	M14	1.5	D6	3
BH607	BM607	M16	2.0	D7	3
BH616	BM616	M16	1.5	D6	3
BH657	BM657	M18	2.5	D7	4
BH676	BM676	M18	1.5	D6	4

► For tapping depth on ANSI Length Taps, refer to MCTI 302 on page 198.

◎ : Excellent ○ : Good

Low carbon steels/ Free machining carbon steels	Medium to high carbon steels/ Low alloyed steels	Steel castings & forgings / Heat-treatable alloy steels	Alloyed tool steels / Mold steels	Free machining stainless steels	Heat-and corrosionresistant stainless steels / Valve stainless steels	Stainless steel castings / Precipitation hardening stainless steels	Pure Aluminum/ Aluminum alloys				
○	◎	◎		◎	◎		○				
Aluminum alloy castings	Grey cast iron	Nodular cast iron / Chilled cast iron / Meehanite iron / Ductile iron	718 & 625 INCO / Waspaloy / Hastelloy / Invar / Monel / Incoloy	718 Inconel / A286	Titanium	Pure and alloyed copper	Free machining brass / Alloyed brass	Bronze	Zinc	Magnesium	
						○	○		○	○	

SPIRAL FLUTE TAPS

BF/BK SERIES

SPIRAL FLUTE TAPS MODIFIED BOTTOMING STYLE for Steels & Stainless Steels up to 35HRc

Hole type 2.5xD

DIN-ANSI Shank

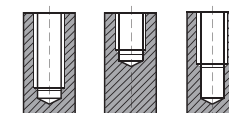
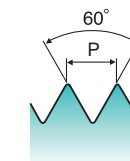

VG
Super HSS
UNC UNF
H2~H6
60°
2P~3P
Steam Oxide
Hardslick
R40

EDP No.		SIZE	Thread Per Inch		Limit	No. of Flute
Steam Oxide	Hardslick		UNC	UNF		
BF082	BK082	2	56	—	H2	2
BF162	BK162	4	40	—	H2	2
BF202	BK202	5	40	—	H2	3
BF243	BK243	6	32	—	H3	3
BF283	BK283	8	32	—	H3	3
BF323	BK323	10	24	—	H3	3
BF343	BK343	10	—	32	H3	3
BF403	BK403	1/4	20	—	H3	3
BF405	BK405	1/4	20	—	H5	3
BF423	BK423	1/4	—	28	H3	3
BF424	BK424	1/4	—	28	H4	3
BF445	BK445	5/16	18	—	H5	3
BF464	BK464	5/16	—	24	H4	3
BF485	BK485	3/8	16	—	H5	3
BF504	BK504	3/8	—	24	H4	3
BF525	BK525	7/16	14	—	H5	3
BF545	BK545	7/16	—	20	H5	3
BF565	BK565	1/2	13	—	H5	3
BF585	BK585	1/2	—	20	H5	3
BF605	BK605	9/16	12	—	H5	3
BF625	BK625	9/16	—	18	H5	3
BF645	BK645	5/8	11	—	H5	4
BF665	BK665	5/8	—	18	H5	4
BF705	BK705	3/4	10	—	H5	4
BF725	BK725	3/4	—	16	H5	4
BF746	BK746	7/8	9	—	H6	4
BF766	BK766	7/8	—	14	H6	4
BF786	BK786	1	8	—	H6	4
BF806	BK806	1	—	12	H6	4
BF836	BK836	1-1/8	8	—	H6	4
BF876	BK876	1-1/4	8	—	H6	4
BF916	BK916	1-3/8	8	—	H6	4
BF956	BK956	1-1/2	8	—	H6	4

► For tapping depth on DIN / ANSI Shank Taps, refer to DIN Table on page 199 & 200.

◎ : Excellent ○ : Good

Low carbon steels/ Free machining carbon steels	Medium to high carbon steels/ Low alloyed steels	Steel castings & forgings / Heat-treatable alloy steels	Alloyed tool steels / Mold steels	Free machining stainless steels	Heat-and corrosionresistant stainless steels / Valve stainless steels	Stainless steel castings / Precipitation hardening stainless steels	Pure Aluminum/ Aluminum alloys				
○	◎	◎		◎	◎		○				
Aluminum alloy castings	Grey cast iron	Nodular cast iron / Chilled cast iron / Meehanite iron / Ductile iron	718 & 625 INCO / Waspaloy / Hastelloy / Invar / Monel / Incoloy	718 Inconel / A286	Titanium	Pure and alloyed copper	Free machining brass / Alloyed brass	Bronze	Zinc	Magnesium	
						○	○		○	○	

SPIRAL FLUTE TAPS

BD/BO SERIES

SPIRAL FLUTE TAPS

H5/H7/H8 SERIES

METRIC SPIRAL FLUTE TAPS MODIFIED BOTTOMING STYLE for Steels & Stainless Steels up to 35HRc

SPIRAL FLUTE TAPS MODIFIED BOTTOMING STYLE Steels up to 45HRc

Hole type 2.5xD

Hole type 2.5xD

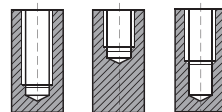

DIN-ANSI Shank

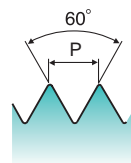

USCTI

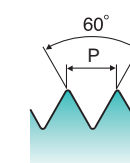

* New Surface Treatment

VG Super HSS M MF D3-D7 60° 2P~3P Steam Oxide Hardslick R40

HR P-HSS UNC UNF USCTI 302A H2-H5 60° 2P~3P Steam Oxide TiCN Hardslick R15

EDP No.	SIZE		Pitch	Limit	No. of Flute
	Steam Oxide	Hardslick			
BD203	BO203	M3	0.5	D3	3
BD224	BO224	M3.5	0.6	D4	3
BD244	BO244	M4	0.7	D4	3
BD284	BO284	M5	0.8	D4	3
BD315	BO315	M6	1.0	D5	3
BD345	BO345	M7	1.0	D5	3
BD365	BO365	M8	1.25	D5	3
BD375	BO375	M8	1.0	D5	3
BD426	BO426	M10	1.5	D6	3
BD435	BO435	M10	1.25	D5	3
BD506	BO506	M12	1.75	D6	3
BD525	BO525	M12	1.25	D5	3
BD547	BO547	M14	2.0	D7	3
BD556	BO556	M14	1.5	D6	3
BD607	BO607	M16	2.0	D7	3
BD616	BO616	M16	1.5	D6	3
BD657	BO657	M18	2.5	D7	4
BD676	BO676	M18	1.5	D6	4

► For tapping depth on DIN / ANSI Shank Taps, refer to DIN Table on page 199 & 200.

EDP No.	Thread Per Inch		SIZE	Limit	No. of Flute
	UNC	UNF			
* H5082	H7082	H8082	2	H2	3
* H5162	H7162	H8162	4	H2	3
* H5202	H7202	H8202	5	H2	3
* H5243	H7243	H8243	6	H3	3
* H5283	H7283	H8283	8	H3	3
* H5323	H7323	H8323	10	H3	3
* H5343	H7343	H8343	10	H3	3
* H5405	H7405	H8405	1/4	H5	3
* H5424	H7424	H8424	1/4	H4	3
* H5445	H7445	H8445	5/16	H5	3
* H5464	H7464	H8464	5/16	H4	3
* H5485	H7485	H8485	3/8	H5	3
* H5504	H7504	H8504	3/8	H4	3
* H5525	H7525	H8525	7/16	H5	3
* H5545	H7545	H8545	7/16	H5	3
* H5565	H7565	H8565	1/2	H5	3
* H5585	H7585	H8585	1/2	H5	3
* H5645	H7645	H8645	5/8	H5	4
* H5665	H7665	H8665	5/8	H5	4
* H5705	H7705	H8705	3/4	H5	4
* H5725	H7725	H8725	3/4	H5	4

► Bright Finish Available: H6 Series

► For tapping depth on ANSI Length Taps, refer to MCTI 302 on page 197.

◎ : Excellent ○ : Good

Low carbon steels / Free machining carbon steels	Medium to high carbon steels / Low alloyed steels	Steel castings & forgings / Heat-treatable alloy steels	Alloyed tool steels / Mold steels	Free machining stainless steels	Heat-and corrosionresistant stainless steels / Valve stainless steels	Stainless steel castings / Precipitation hardening stainless steels	Pure Aluminum / Aluminum alloys			
○	◎	◎		◎	◎		○			
Aluminum alloy castings	Grey cast iron	Nodular cast iron / Chilled cast iron / Meehanite iron / Ductile iron	718 & 625 INCO / Waspaloy / Hastelloy / Invar / Monel / Incoloy	718 Inconel / A286	Titanium	Pure and alloyed copper	Free machining brass / Alloyed brass	Bronze	Zinc	Magnesium
					○	○		○	○	○

◎ : Excellent ○ : Good

Low carbon steels / Free machining carbon steels	Medium to high carbon steels / Low alloyed steels	Steel castings & forgings / Heat-treatable alloy steels	Alloyed tool steels / Mold steels	Free machining stainless steels	Heat-and corrosionresistant stainless steels / Valve stainless steels	Stainless steel castings / Precipitation hardening stainless steels	Pure Aluminum / Aluminum alloys			
		○	◎		○	◎				
Aluminum alloy castings	Grey cast iron	Nodular cast iron / Chilled cast iron / Meehanite iron / Ductile iron	718 & 625 INCO / Waspaloy / Hastelloy / Invar / Monel / Incoloy	718 Inconel / A286	Titanium	Pure and alloyed copper	Free machining brass / Alloyed brass	Bronze	Zinc	Magnesium
			○	○	○			◎		

SPIRAL FLUTE TAPS

TQ858/TK858/TR858 SERIES

SPIRAL FLUTE TAPS

B3/B5/D6 SERIES

SPIRAL FLUTE TAPS MODIFIED BOTTOMING STYLE Steels up to 45HRc

SPIRAL FLUTE TAPS MODIFIED BOTTOMING STYLE for Titanium Alloys & Nickel Base Alloys up to 44HRc

Hole type 2.5xD

Hole type 2.5xD

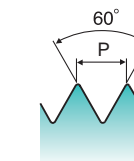
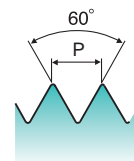
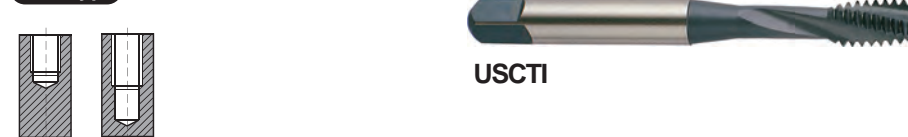

Call for Availability

HR P-HSS M MF USCTI 302A H2-H5 60° 2P~3P Steam Oxide TiCN Hardslick R15

Ti Ni P-HSS UNC UNF USCTI 302A H2-H5 60° 2P~3P Steam Oxide TiCN Hardslick R15

	EDP No.			SIZE	Pitch	Limit	No. of Flute
	Steam Oxide	TiCN	Hardslick				
	TQ858203	TK858203	TR858203HAR	M3	0.50	D3	3
	TQ858253	TK858253	TR858253HAR	M4	0.50	D3	3
	TQ858244	TK858244	TR858244HAR	M4	0.70	D4	3
	TQ858293	TK858293	TR858293HAR	M5	0.50	D3	3
	TQ858284	TK858284	TR858284HAR	M5	0.80	D4	3
	TQ858333	TK858333	TR858333HAR	M6	0.50	D3	3
	TQ858324	TK858324	TR858324HAR	M6	0.75	D4	3
	TQ858315	TK858315	TR858315HAR	M6	1.00	D5	3
	TQ858375	TK858375	TR858375HAR	M8	1.00	D5	3
	TQ858365	TK858365	TR858365HAR	M8	1.25	D5	3
	TQ858445	TK858445	TR858445HAR	M10	1.00	D5	3
	TQ858435	TK858435	TR858435HAR	M10	1.25	D5	3
	TQ858426	TK858426	TR858426HAR	M10	1.50	D6	3
	TQ858535	TK858535	TR858535HAR	M12	1.00	D5	3
	TQ858526	TK858526	TR858526HAR	M12	1.25	D6	3
	TQ858516	TK858516	TR858516HAR	M12	1.50	D6	3
	TQ858506	TK858506	TR858506HAR	M12	1.75	D6	3
	TQ858556	TK858556	TR858556HAR	M14	1.50	D6	3
	TQ858547	TK858547	TR858547HAR	M14	2.00	D7	3
	TQ858616	TK858616	TR858616HAR	M16	1.5	D6	4
	TQ858607	TK858607	TR858607HAR	M16	2.0	D7	4
	TQ858676	TK858676	TR858676HAR	M18	1.5	D6	4
	TQ858657	TK858657	TR858657HAR	M18	2.5	D7	4
	TQ858726	TK858726	TR858726HAR	M20	1.5	D6	4
	TQ858707	TK858707	TR858707HAR	M20	2.5	D7	4
	TQ858766	TK858766	TR858766HAR	M22	1.5	D6	4
	TQ858747	TK858747	TR858747HAR	M22	2.5	D7	4
	TQ858806	TK858806	TR858806HAR	M24	1.5	D6	4
	TQ858788	TK858788	TR858788HAR	M24	3.0	D8	4

For tapping depth on ANSI Length Taps, refer to MCTI 302 on page 198.

	EDP No.			SIZE	Thread Per Inch		Limit	No. of Flute
	Steam Oxide	TiCN	Hardslick		UNC	UNF		
	B3082	B5082	D6082	2	56	—	H2	3
	B3162	B5162	D6162	4	40	—	H2	3
	B3202	B5202	D6202	5	40	—	H2	3
	B3243	B5243	D6243	6	32	—	H3	3
	B3283	B5283	D6283	8	32	—	H3	3
	B3323	B5323	D6323	10	24	—	H3	3
	B3343	B5343	D6343	10	—	32	H3	3
	B3403	B5403	D6403	1/4	20	—	H3	3
	B3405	B5405	D6405	1/4	20	—	H5	3
	B3423	B5423	D6423	1/4	—	28	H3	3
	B3424	B5424	D6424	1/4	—	28	H4	3
	B3443	B5443	D6443	5/16	18	—	H3	3
	B3445	B5445	D6445	5/16	18	—	H5	3
	B3463	B5463	D6463	5/16	—	24	H3	3
	B3483	B5483	D6483	3/8	16	—	H3	3
	B3485	B5485	D6485	3/8	16	—	H5	3
	B3503	B5503	D6503	3/8	—	24	H3	3
	B3504	B5504	D6504	3/8	—	24	H4	3
	B3523	B5523	D6523	7/16	14	—	H3	3
	B3525	B5525	D6525	7/16	14	—	H5	3
	B3543	B5543	D6543	7/16	—	20	H3	3
	B3545	B5545	D6545	7/16	—	20	H5	3
	B3563	B5563	D6563	1/2	13	—	H3	3
	B3565	B5565	D6565	1/2	13	—	H5	3
	B3583	B5583	D6583	1/2	—	20	H3	3
	B3585	B5585	D6585	1/2	—	20	H5	3
	B3603	B5603	D6603	9/16	12	—	H3	3
	B3605	B5605	D6605	9/16	12	—	H5	3
	B3623	B5623	D6623	9/16	—	18	H3	3
	B3625	B5625	D6625	9/16	—	18	H5	3

TiN Coated Available: H9 Series
For tapping depth on ANSI Length Taps, refer to MCTI 302 on page 197.

NEXT PAGE

© : Excellent ○ : Good

© : Excellent ○ : Good

Low carbon steels / Free machining carbon steels	Medium to high carbon steels / Low alloyed steels	Steel castings & forgings / Heat-treatable alloy steels	Alloyed tool steels / Mold steels	Free machining stainless steels	Heat-and corrosionresistant stainless steels / Valve stainless steels	Stainless steel castings / Precipitation hardening stainless steels	Pure Aluminum / Aluminum alloys														
Aluminum alloy castings	Grey cast iron	Nodular cast iron / Chilled cast iron / Meehanite iron / Ductile iron	718 & 625 INCO / Waspaloy / Hastelloy / Invar / Monel / Incoloy	718 Inconel / A286	Titanium	Pure and alloyed copper	Free machining brass / Alloyed brass	Bronze	Zinc	Magnesium											

Low carbon steels / Free machining carbon steels	Medium to high carbon steels / Low alloyed steels	Steel castings & forgings / Heat-treatable alloy steels	Alloyed tool steels / Mold steels	Free machining stainless steels	Heat-and corrosionresistant stainless steels / Valve stainless steels	Stainless steel castings / Precipitation hardening stainless steels	Pure Aluminum / Aluminum alloys														
Aluminum alloy castings	Grey cast iron	Nodular cast iron / Chilled cast iron / Meehanite iron / Ductile iron	718 & 625 INCO / Waspaloy / Hastelloy / Invar / Monel / Incoloy	718 Inconel / A286	Titanium	Pure and alloyed copper	Free machining brass / Alloyed brass	Bronze	Zinc	Magnesium											

SPIRAL FLUTE TAPS

B3/B5/D6 SERIES

SPIRAL FLUTE TAPS MODIFIED BOTTOMING STYLE for Titanium Alloys & Nickel Base Alloys up to 44HRc

Hole type 2.5xD

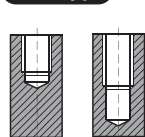

USCTI

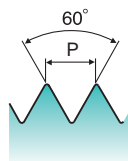

Ti Ni
P-HSS
UNC UNF
USCTI 302A
H2-H5
60°
2P~3P
Steam Oxide
TiCN
Hardslick
R15

	EDP No.			SIZE	Thread Per Inch		Limit	No. of Flute
	Steam Oxide	TiCN	Hardslick		UNC	UNF		
	B3643	B5643	D6643	5/8	11	—	H3	4
	B3645	B5645	D6645	5/8	11	—	H5	4
	B3663	B5663	D6663	5/8	—	18	H3	4
	B3665	B5665	D6665	5/8	—	18	H5	4
	B3703	B5703	D6703	3/4	10	—	H3	4
	B3705	B5705	D6705	3/4	10	—	H5	4
	B3723	B5723	D6723	3/4	—	16	H3	4
	B3725	B5725	D6725	3/4	—	16	H5	4

▶ TiN Coated Available: H9 Series
 ▶ For tapping depth on ANSI Length Taps, refer to MCT1 302 on page 197.

◎ : Excellent ○ : Good

Low carbon steels/ Free machining carbon steels	Medium to high carbon steels/ Low alloyed steels	Steel castings & forgings / Heat-treatable alloy steels	Alloyed tool steels / Mold steels	Free machining stainless steels	Heat-and corrosionresistant stainless steels / Valve stainless steels	Stainless steel castings / Precipitation hardening stainless steels	Pure Aluminum/ Aluminum alloys				
Aluminum alloy castings	Grey cast iron	Nodular cast iron / Chilled cast iron / Meehanite iron / Ductile iron	718 & 625 INCO / Waspaloy / Hastelloy / Invar / Monel / Incoloy	718 Inconel / A286	Titanium	Pure and alloyed copper	Free machining brass / Alloyed brass	Bronze	Zinc	Magnesium	
			◎	◎	◎						

SPIRAL FLUTE TAPS

G9/H0 SERIES

SPIRAL FLUTE TAPS MODIFIED BOTTOMING STYLE for Stainless Steels up to 28HRc

Maximum Tapping Depth is 50% Deeper than Standard USCTI Taps.

Hole type 2.5xD

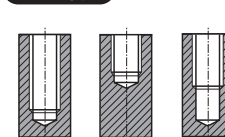

USCTI Long Shank

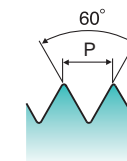

VA
P-HSS
UNC UNF
USCTI Long Shank
H2-H3
60°
2P~3P
Hardslick
R45

	EDP No.		SIZE	Thread Per Inch		Limit	No. of Flute
	Hardslick Coated 4" OAL	Hardslick Coated 6" OAL		UNC	UNF		
	G9162	—	4	40	—	H2	3
	G9243	H0243	6	32	—	H3	3
	G9283	H0283	8	32	—	H3	3
	G9323	H0323	10	24	—	H3	3
	G9343	H0343	10	—	32	H3	3
	G9403	H0403	1/4	20	—	H3	3
	—	H0423	1/4	—	28	H3	3
	—	H0443	5/16	18	—	H3	3
	—	H0463	5/16	—	24	H3	3
	—	H0483	3/8	16	—	H3	3
	—	H0503	3/8	—	24	H3	3
	—	H0523	7/16	14	—	H3	3
	—	H0543	7/16	—	20	H3	3
	—	H0563	1/2	13	—	H3	3
	—	H0583	1/2	—	20	H3	3
	—	H0643	5/8	11	—	H3	4

▶ TiN Coated Available: 4" OAL G7 Series & 6" OAL G8 Series
 ▶ For tapping depth on DIN / ANSI Shank Taps, refer to DIN Table on page 199 & 200.

◎ : Excellent ○ : Good

Low carbon steels/ Free machining carbon steels	Medium to high carbon steels/ Low alloyed steels	Steel castings & forgings / Heat-treatable alloy steels	Alloyed tool steels / Mold steels	Free machining stainless steels	Heat-and corrosionresistant stainless steels / Valve stainless steels	Stainless steel castings / Precipitation hardening stainless steels	Pure Aluminum/ Aluminum alloys				
Aluminum alloy castings	Grey cast iron	Nodular cast iron / Chilled cast iron / Meehanite iron / Ductile iron	718 & 625 INCO / Waspaloy / Hastelloy / Invar / Monel / Incoloy	718 Inconel / A286	Titanium	Pure and alloyed copper	Free machining brass / Alloyed brass	Bronze	Zinc	Magnesium	
						○	○		○	○	

SPIRAL FLUTE TAPS

H2/H4 SERIES

SPIRAL FLUTE TAPS

BG/BG-GB SERIES

SPIRAL FLUTE TAPS MODIFIED BOTTOMING STYLE Machining Center Tap (Left hand spiral)

SPIRAL FLUTE TAPS MODIFIED BOTTOMING STYLE for Stainless Steel up to 35HRc

Left hand spiral, right hand cut. Reduces chip packing in deep holes Maximum. Tapping Depth is 50% Deeper than Standard USCTI Taps.

Hole type 3.0xD

Oil Field

Hole type 2.5xD

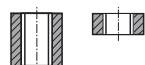

USCTI Long Shank

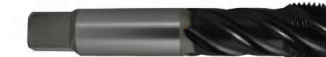
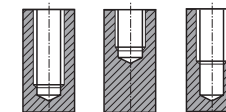
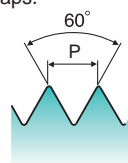

DIN-ANSI Shank

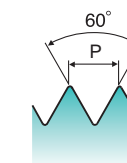

VA P-HSS UNC UNF USCTI Long Shank H3 60° 4P~5P TiN Hardslick L15

VG HSSE-V3 UNC UN8 2B 60° 2P~3P Hardslick Gold&Black R40

EDP No.	SIZE	Thread Per Inch		Limit	Overall	No. of Flute
		UNC	UNF			
H2403	1/4	20	—	H3	6"	2
H2423	1/4	—	28	H3	6"	3
H2443	5/16	18	—	H3	6"	3
H2483	3/8	16	—	H3	6"	3
H2523	7/16	14	—	H3	6"	3
H2563	1/2	13	—	H3	6"	3
H2643	5/8	11	—	H3	6"	3

EDP No.	SIZE	Thread Per Inch		Limit	No. of Flute
		UNC	UN		
BG562H	1/2	13	—	2B	3
BG642H	5/8	11	—	2B	3
BG702H	3/4	10	—	2B	3
BG742H	7/8	9	—	2B	4
BG782H	1	—	8	2B	4
BG822H	1-1/8	7	—	2B	4
BG832H	1-1/8	—	8	2B	4
BG862H	1-1/4	7	—	2B	4
BG872H	1-1/4	—	8	2B	4
BG912H	1-3/8	—	8	2B	5
BG952H	1-1/2	—	8	2B	5
BGB22H	1-5/8	—	8	2B	5
BGC02H	1-3/4	—	8	2B	6
BGC62H	1-7/8	—	8	2B	6
BGD42H	2	—	8	2B	6

► For tapping depth on DIN / ANSI Shank Taps, refer to DIN Table on page 199 & 200.

► For tapping depth on DIN / ANSI Shank Taps, refer to DIN Table on page 199 & 200.

◎ : Excellent ○ : Good

Low carbon steels/ Free machining carbon steels	Medium to high carbon steels/ Low alloyed steels	Steel castings & forgings / Heat-treatable alloy steels	Alloyed tool steels / Mold steels	Free machining stainless steels	Heat-and corrosionresistant stainless steels / Valve stainless steels	Stainless steel castings / Precipitation hardening stainless steels	Pure Aluminum/ Aluminum alloys			
○	◎			◎			○			
Aluminum alloy castings	Grey cast iron	Nodular cast iron / Chilled cast iron / Meehanite iron / Ductile iron	718 & 625 INCO / Waspaloy / Hastelloy / Invar / Monel / Incoloy	718 Inconel / A286	Titanium	Pure and alloyed copper	Free machining brass / Alloyed brass	Bronze	Zinc	Magnesium
					○	○		○	○	

◎ : Excellent ○ : Good

Low carbon steels/ Free machining carbon steels	Medium to high carbon steels/ Low alloyed steels	Steel castings & forgings / Heat-treatable alloy steels	Alloyed tool steels / Mold steels	Free machining stainless steels	Heat-and corrosionresistant stainless steels / Valve stainless steels	Stainless steel castings / Precipitation hardening stainless steels	Pure Aluminum/ Aluminum alloys			
	○	◎		◎	◎					
Aluminum alloy castings	Grey cast iron	Nodular cast iron / Chilled cast iron / Meehanite iron / Ductile iron	718 & 625 INCO / Waspaloy / Hastelloy / Invar / Monel / Incoloy	718 Inconel / A286	Titanium	Pure and alloyed copper	Free machining brass / Alloyed brass	Bronze	Zinc	Magnesium
◎										

YG SPIRAL FLUTE TAPS

B1/B0/B2/D2 SERIES

YG SPIRAL FLUTE TAPS

B1/B0/B2/D2 SERIES

SPIRAL FLUTE TAPS MODIFIED BOTTOMING STYLE for Stainless Steels up to 28HRc

SPIRAL FLUTE TAPS MODIFIED BOTTOMING STYLE for Stainless Steels up to 28HRc

Hole type 2.5xD

Hole type 2.5xD

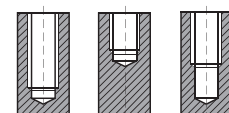
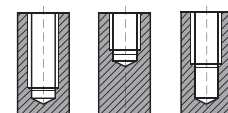

USCTI

USCTI

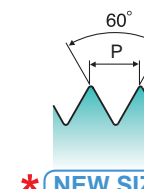
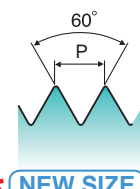

* NEW SIZE

* NEW SIZE

VA HSSE-V3 UNC UNF USCTI 302A H2-H7 60° 2P~3P Bright Steam Oxide TiN Hardslick R45

VA HSSE-V3 UNC UNF USCTI 302A H2-H7 60° 2P~3P Bright Steam Oxide TiN Hardslick R45

	EDP No.				SIZE	Thread Per Inch		Limit	No. of Flute
	Bright	Steam Oxide	TiN	Hardslick		UNC	UNF		
	B1082	B0082	B2082	D2082	2	56	—	H2	2
	—	* B0122	—	* D2122	3	48	—	H2	2
	B1162	B0162	B2162	D2162	4	40	—	H2	2
	—	* B0163	—	* D2163	4	40	—	H3	2
	—	* B0164	—	* D2164	4	40	—	H4	2
	B1162	B0162	B2162	D2162	4	40	—	H5	2
	B1162	B0162	B2162	D2162	4	40	—	H6	2
	—	* B0182	—	* D2182	4	—	48	H2	2
	B1202	B0202	B2202	D2202	5	40	—	H2	3
	—	* B0242	—	* D2242	6	32	—	H2	3
	B1243	B0243	B2243	D2243	6	32	—	H3	3
	—	* B0244	—	* D2244	6	32	—	H4	3
	—	* B0245	—	* D2245	6	32	—	H5	3
	—	* B0247	—	* D2247	6	32	—	H7	3
	—	* B0262	—	* D2262	6	—	40	H2	3
	—	* B0263	—	* D2263	6	—	40	H3	3
	—	* B0282	—	* D2282	8	32	—	H2	3
	B1283	B0283	B2283	D2283	8	32	—	H3	3
	—	* B0284	—	* D2284	8	32	—	H4	3
	—	* B0285	—	* D2285	8	32	—	H5	3
	—	* B0286	—	* D2286	8	32	—	H6	3
	—	* B0287	—	* D2287	8	32	—	H7	3
	—	* B0303	—	* D2303	8	—	36	H3	3
	—	* B0322	—	* D2322	10	24	—	H2	3
	B1323	B0323	B2323	D2323	10	24	—	H3	3
	—	* B0325	—	* D2325	10	24	—	H5	3
	—	* B0327	—	* D2327	10	24	—	H7	3
	—	* B0342	—	* D2342	10	—	32	H2	3
	B1343	B0343	B2343	D2343	10	—	32	H3	3
	—	* B0344	—	* D2344	10	—	32	H4	3
	—	* B0345	—	* D2345	10	—	32	H5	3

	EDP No.				SIZE	Thread Per Inch		Limit	No. of Flute
	Bright	Steam Oxide	TiN	Hardslick		UNC	UNF		
	—	* B0346	—	* D2346	10	—	32	H6	3
	—	* B0347	—	* D2347	10	—	32	H7	3
	—	* B0363	—	* D2363	12	24	—	H3	3
	—	* B0383	—	* D2383	12	28	—	H3	3
	—	* B0402	—	* D2402	1/4	20	—	H2	3
	B1403	B0403	B2403	D2403	1/4	20	—	H3	3
	B1405	B0405	B2405	D2405	1/4	20	—	H5	3
	—	* B0407	—	* D2407	1/4	20	—	H7	3
	—	* B0422	—	* D2422	1/4	—	28	H2	3
	B1423	B0423	B2423	D2423	1/4	—	28	H3	3
	—	* B0424	—	* D2424	1/4	—	28	H4	3
	—	* B0425	—	* D2425	1/4	—	28	H5	3
	—	* B0426	—	* D2426	1/4	—	28	H6	3
	—	* B0427	—	* D2427	1/4	—	28	H7	3
	B1443	B0443	B2443	D2443	5/16	18	—	H3	3
	B1445	B0445	B2445	D2445	5/16	18	—	H5	3
	—	* B0447	—	* D2447	5/16	18	—	H7	3
	B1463	B0463	B2463	D2463	5/16	—	24	H3	3
	—	* B0464	—	* D2464	5/16	—	24	H4	3
	—	* B0465	—	* D2465	5/16	—	24	H5	3
	—	* B0467	—	* D2467	5/16	—	24	H7	3
	B1483	B0483	B2483	D2483	3/8	16	—	H3	3
	B1485	B0485	B2485	D2485	3/8	16	—	H5	3
	—	* B0487	—	* D2487	3/8	16	—	H7	3
	B1503	B0503	B2503	D2503	3/8	—	24	H3	3
	—	* B0504	—	* D2504	3/8	—	24	H4	3
	—	* B0505	—	* D2505	3/8	—	24	H5	3
	B1523	B0523	B2523	D2523	7/16	14	—	H3	3
	B1525	B0525	B2525	D2525	7/16	14	—	H5	3
	—	* B0527	—	* D2527	7/16	14	—	H7	3
	B1543	B0543	B2543	D2543	7/16	—	20	H3	3

► For tapping depth on ANSI Length Taps, refer to MCTI 302 on page 197. ◀ NEXT PAGE

► For tapping depth on ANSI Length Taps, refer to MCTI 302 on page 197. ◀ NEXT PAGE

◎ : Excellent ○ : Good

◎ : Excellent ○ : Good

Low carbon steels / Free machining carbon steels	Medium to high carbon steels / Low alloyed steels	Steel castings & forgings / Heat-treatable alloy steels	Alloyed tool steels / Mold steels	Free machining stainless steels	Heat-and corrosionresistant stainless steels / Valve stainless steels	Stainless steel castings / Precipitation hardening stainless steels	Pure Aluminum / Aluminum alloys				
○	◎			◎			○				
Aluminum alloy castings	Grey cast iron	Nodular cast iron / Chilled cast iron / Meehanite iron / Ductile iron	718 & 625 INCO / Waspaloy / Hastelloy / Invar / Monel / Incoloy	718 Inconel / A286	Titanium	Pure and alloyed copper	Free machining brass / Alloyed brass	Bronze	Zinc	Magnesium	
						○	○		○	○	

Low carbon steels / Free machining carbon steels	Medium to high carbon steels / Low alloyed steels	Steel castings & forgings / Heat-treatable alloy steels	Alloyed tool steels / Mold steels	Free machining stainless steels	Heat-and corrosionresistant stainless steels / Valve stainless steels	Stainless steel castings / Precipitation hardening stainless steels	Pure Aluminum / Aluminum alloys				
○	◎			◎			○				
Aluminum alloy castings	Grey cast iron	Nodular cast iron / Chilled cast iron / Meehanite iron / Ductile iron	718 & 625 INCO / Waspaloy / Hastelloy / Invar / Monel / Incoloy	718 Inconel / A286	Titanium	Pure and alloyed copper	Free machining brass / Alloyed brass	Bronze	Zinc	Magnesium	
						○	○		○	○	

SPIRAL FLUTE TAPS

B1/B0/B2/D2 SERIES

SPIRAL FLUTE TAPS

BS/BT SERIES

SPIRAL FLUTE TAPS MODIFIED BOTTOMING STYLE for Stainless Steels up to 28HRc

METRIC SPIRAL FLUTE TAPS MODIFIED BOTTOMING STYLE for Stainless Steels up to 28HRc

Hole type 2.5xD

Hole type 2.5xD

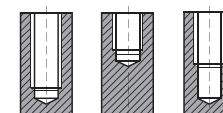
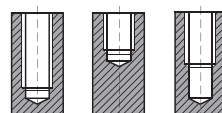

USCTI

USCTI

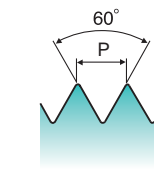
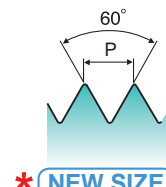

* NEW SIZE

VA HSSE-V3 UNC UNF USCTI 302A H2-H7 60° 2P~3P Bright Steam Oxide TIN Hardslick R45

VA HSSE-V3 M MF USCTI 302A D3-D7 60° 2P~3P Steam Oxide Hardslick R45

	EDP No.				SIZE	Thread Per Inch		Limit	No. of Flute
	Bright	Steam Oxide	TiN	Hardslick		UNC	UNF		
	B1545	B0545	B2545	D2545	7/16	—	20	H5	3
	—	* B0547	—	* D2547	7/16	—	20	H7	3
	B1563	B0563	B2563	D2563	1/2	13	—	H3	3
	B1565	B0565	B2565	D2565	1/2	13	—	H5	3
	—	* B0567	—	* D2567	1/2	13	—	H7	3
	B1583	B0583	B2583	D2583	1/2	—	20	H3	3
	—	* B0585	—	* D2585	1/2	—	20	H5	3
	—	* B0586	—	* D2586	1/2	—	20	H6	3
	—	* B0587	—	* D2587	1/2	—	20	H7	3
	B1603	B0603	B2603	D2603	9/16	12	—	H3	3
	B1623	B0623	B2623	D2623	9/16	—	18	H3	3
	B1643	B0643	B2643	D2643	5/8	11	—	H3	4
	B1645	B0645	B2645	D2645	5/8	11	—	H5	4
	B1663	B0663	B2663	D2663	5/8	—	18	H3	4
	B1665	B0665	B2665	D2665	5/8	—	18	H5	4
	B1703	B0703	B2703	D2703	3/4	10	—	H3	4
	—	* B0706	—	* D2706	3/4	10	—	H6	4
	B1723	B0723	B2723	D2723	3/4	—	16	H3	4
	B1725	B0725	B2725	D2725	3/4	—	16	H5	4
	B1744	B0744	B2744	D2744	7/8	9	—	H4	4
	B1764	B0764	B2764	D2764	7/8	—	14	H4	4
	B1784	B0784	B2784	D2784	1	8	—	H4	4
	B1804	B0804	B2804	D2804	1	—	12	H4	4

	EDP No.		SIZE	Pitch	Limit	No. of Flute
	Steam Oxide	Hardslick				
	BS203	BT203	M3	0.5	D3	3
	BS224	BT224	M3.5	0.6	D4	3
	BS244	BT244	M4	0.7	D4	3
	BS284	BT284	M5	0.8	D4	3
	BS315	BT315	M6	1.0	D5	3
	BS345	BT345	M7	1.0	D5	3
	BS365	BT365	M8	1.25	D5	3
	BS375	BT375	M8	1.0	D5	3
	BS426	BT426	M10	1.5	D6	3
	BS435	BT435	M10	1.25	D5	3
	BS506	BT506	M12	1.75	D6	3
	BS525	BT525	M12	1.25	D5	3
	BS547	BT547	M14	2.0	D7	3
	BS556	BT556	M14	1.5	D6	3
	BS607	BT607	M16	2.0	D7	3
	BS616	BT616	M16	1.5	D6	3
	BS657	BT657	M18	2.5	D7	4
	BS676	BT676	M18	1.5	D6	4

► For tapping depth on ANSI Length Taps, refer to MCTI 302 on page 197.

► For tapping depth on ANSI Length Taps, refer to MCTI 302 on page 197.

◎ : Excellent ○ : Good

◎ : Excellent ○ : Good

Low carbon steels / Free machining carbon steels	Medium to high carbon steels / Low alloyed steels	Steel castings & forgings / Heat-treatable alloy steels	Alloyed tool steels / Mold steels	Free machining stainless steels	Heat-and corrosionresistant stainless steels / Valve stainless steels	Stainless steel castings / Precipitation hardening stainless steels	Pure Aluminum / Aluminum alloys			
○	◎			◎			○			
Aluminum alloy castings	Grey cast iron	Nodular cast iron / Chilled cast iron / Meehanite iron / Ductile iron	718 & 625 INCO / Waspalloy / Hastelloy / Invar / Monel / Incoloy	718 Inconel / A286	Titanium	Pure and alloyed copper	Free machining brass / Alloyed brass	Bronze	Zinc	Magnesium
					○	○		○	○	○

Low carbon steels / Free machining carbon steels	Medium to high carbon steels / Low alloyed steels	Steel castings & forgings / Heat-treatable alloy steels	Alloyed tool steels / Mold steels	Free machining stainless steels	Heat-and corrosionresistant stainless steels / Valve stainless steels	Stainless steel castings / Precipitation hardening stainless steels	Pure Aluminum / Aluminum alloys			
○	◎			◎			○			
Aluminum alloy castings	Grey cast iron	Nodular cast iron / Chilled cast iron / Meehanite iron / Ductile iron	718 & 625 INCO / Waspalloy / Hastelloy / Invar / Monel / Incoloy	718 Inconel / A286	Titanium	Pure and alloyed copper	Free machining brass / Alloyed brass	Bronze	Zinc	Magnesium
					○	○		○	○	○

SPIRAL FLUTE TAPS

E6/E8/E9 SERIES

SPIRAL FLUTE TAPS

D3/E0 SERIES

METRIC SPIRAL FLUTE TAPS MODIFIED BOTTOMING STYLE for Stainless Steels up to 28HRc

SPIRAL FLUTE TAPS MODIFIED BOTTOMING STYLE Steels up to 38HRc

Hole type 2.5xD

Hole type 2.5xD

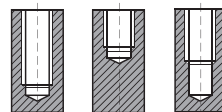

DIN-ANSI Shank

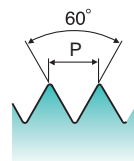

USCTI

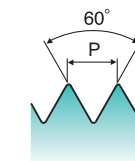

* NEW SIZE

VA HSSE-V3 M MF D3-D7 60° 2P~3P Steam Oxide TiCN Hardslick R45

VG HSSE-V3 UNC UNF USCTI 302A H2-H11 60° 2P~3P Steam Oxide Hardslick R45

EDP No.	Limit			SIZE	Pitch	Limit	No. of Flute
	Steam Oxide	TiCN	Hardslick				
E6203	E8203	E9203	M3	0.5	D3	3	
E6224	E8224	E9224	M3.5	0.6	D4	3	
E6244	E8244	E9244	M4	0.7	D4	3	
E6284	E8284	E9284	M5	0.8	D4	3	
E6315	E8315	E9315	M6	1.0	D5	3	
E6345	E8345	E9345	M7	1.0	D5	3	
E6365	E8365	E9365	M8	1.25	D5	3	
E6375	E8375	E9375	M8	1.0	D5	3	
E6426	E8426	E9426	M10	1.5	D6	3	
E6435	E8435	E9435	M10	1.25	D5	3	
E6506	E8506	E9506	M12	1.75	D6	3	
E6525	E8525	E9525	M12	1.25	D5	3	
E6547	E8547	E9547	M14	2.0	D7	3	
E6556	E8556	E9556	M14	1.5	D6	3	
E6607	E8607	E9607	M16	2.0	D7	3	
E6616	E8616	E9616	M16	1.5	D6	4	
E6657	E8657	E9657	M18	2.5	D7	4	
E6676	E8676	E9676	M18	1.5	D6	4	

EDP No.	Thread Per Inch			Limit	No. of Flute
	Steam Oxide	UNC	UNF		
D3082	E0082	2	56	H2	2
* D3122	* E0122	3	48	H2	2
D3162	E0162	4	40	H2	3
* D3163	* E0163	4	40	H3	3
* D3164	* E0164	4	40	H4	3
* D3165	* E0165	4	40	H5	3
D3162	E0162	4	48	H2	3
D3202	E0202	5	40	H2	3
* D3242	* E0242	6	32	H2	3
D3243	E0243	6	32	H3	3
* D3245	* E0245	6	32	H5	3
* D3247	* E0247	6	32	H7	3
* D324A	* E024A	6	32	H11	3
* D3262	* E0262	6	40	H2	3
* D3282	* E0282	8	32	H2	3
D3283	E0283	8	32	H3	3
* D3285	* E0285	8	32	H5	3
* D3287	* E0287	8	32	H7	3
* D328A	* E028A	8	32	H11	3
D3323	E0323	10	24	H3	3
* D3325	* E0325	10	24	H5	3
* D332A	* E032A	10	24	H11	3
* D3342	* E0342	10	32	H2	3
D3343	E0343	10	32	H3	3
* D3345	* E0345	10	32	H5	3
* D3347	* E0347	10	32	H7	3
* D334A	* E034A	10	32	H11	3
* D3363	* E0363	12	24	H3	3
* D3383	* E0383	12	28	H3	3
* D3402	* E0402	1/4	20	H2	3
D3403	E0403	1/4	20	H3	3
D3405	E0405	1/4	20	H5	3
* D3407	* E0407	1/4	20	H7	3
* D340A	* E040A	1/4	20	H11	3
* D3422	* E0422	1/4	28	H2	3

► For tapping depth on DIN / ANSI Shank Taps, refer to DIN Table on page 199 & 200.

► For tapping depth on ANSI Length Taps, refer to MCTI 302 on page 197.
► Bright Finish Available: D4 Series

► NEXT PAGE
© : Excellent ○ : Good

Low carbon steels/ Free machining carbon steels	Medium to high carbon steels/ Low alloyed steels	Steel castings & forgings / Heat-treatable alloy steels	Alloyed tool steels / Mold steels	Free machining stainless steels	Heat-and corrosionresistant stainless steels / Valve stainless steels	Stainless steel castings / Precipitation hardening stainless steels	Pure Aluminum/ Aluminum alloys					
○	◎			◎			○					
Aluminum alloy castings	Grey cast iron	Nodular cast iron / Chilled cast iron / Meehanite iron / Ductile iron	718 & 625 INCO / Waspaloy / Hastelloy / Invar / Monel / Incoloy	718 Inconel / A286	Titanium	Pure and alloyed copper	Free machining brass / Alloyed brass	Bronze	Zinc	Magnesium		
						○	○		○	○		

Low carbon steels/ Free machining carbon steels	Medium to high carbon steels/ Low alloyed steels	Steel castings & forgings / Heat-treatable alloy steels	Alloyed tool steels / Mold steels	Free machining stainless steels	Heat-and corrosionresistant stainless steels / Valve stainless steels	Stainless steel castings / Precipitation hardening stainless steels	Pure Aluminum/ Aluminum alloys					
	◎	◎		○	○							
Aluminum alloy castings	Grey cast iron	Nodular cast iron / Chilled cast iron / Meehanite iron / Ductile iron	718 & 625 INCO / Waspaloy / Hastelloy / Invar / Monel / Incoloy	718 Inconel / A286	Titanium	Pure and alloyed copper	Free machining brass / Alloyed brass	Bronze	Zinc	Magnesium		
						○						

SPIRAL FLUTE TAPS

D3/E0 SERIES

SPIRAL FLUTE TAPS

D3/E0 SERIES

SPIRAL FLUTE TAPS MODIFIED BOTTOMING STYLE Steels up to 38HRc

SPIRAL FLUTE TAPS MODIFIED BOTTOMING STYLE Steels up to 38HRc

A variety of H Limit

A variety of H Limit

Hole type 2.5xD

Hole type 2.5xD

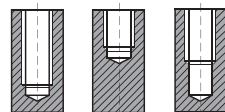

USCTI

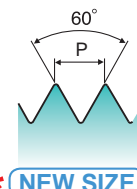

* NEW SIZE

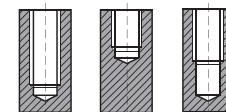

USCTI

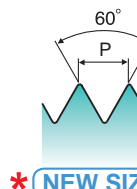

* NEW SIZE

VG HSSE-V3 UNC UNF USCTI 302A H2-H11 60° 2P~3P Steam Oxide Hardslick R45

VG HSSE-V3 UNC UNF USCTI 302A H2-H11 60° 2P~3P Steam Oxide Hardslick R45

EDP No.	SIZE		Thread Per Inch			Limit	No. of Flute
	Steam Oxide	Hardslick	UNC	UNF	8 Pitch		
D3423	E0423	1/4	—	28	—	H3	3
* D3424	* E0424	1/4	—	28	—	H4	3
D3425	E0425	1/4	—	28	—	H5	3
* D3427	* E0427	1/4	—	28	—	H7	3
* D342A	* E042A	1/4	—	28	—	H11	3
* D3442	* E0442	5/16	18	—	—	H2	3
D3443	E0443	5/16	18	—	—	H3	3
D3445	E0445	5/16	18	—	—	H5	3
* D3447	* E0447	5/16	18	—	—	H7	3
* D344A	* E044A	5/16	18	—	—	H11	3
* D3462	* E0462	5/16	—	24	—	H2	3
D3463	E0463	5/16	—	24	—	H3	3
* D3464	* E0464	5/16	—	24	—	H4	3
D3465	E0465	5/16	—	24	—	H5	3
* D3466	* E0466	5/16	—	24	—	H6	3
* D3467	* E0467	5/16	—	24	—	H7	3
* D346A	* E046A	5/16	—	24	—	H11	3
* D3482	* E0482	3/8	16	—	—	H2	3
D3483	E0483	3/8	16	—	—	H3	3
D3485	E0485	3/8	16	—	—	H5	3
* D3487	* E0487	3/8	16	—	—	H7	3
* D348A	* E048A	3/8	16	—	—	H11	3
* D3502	* E0502	3/8	—	24	—	H2	3
D3503	E0503	3/8	—	24	—	H3	3
* D3504	* E0504	3/8	—	24	—	H4	3
D3505	E0505	3/8	—	24	—	H5	3
* D3507	* E0507	3/8	—	24	—	H7	3
* D350A	* E050A	3/8	—	24	—	H11	3
D3523	E0523	7/16	14	—	—	H3	3
D3525	E0525	7/16	14	—	—	H5	3
* D3527	* E0527	7/16	14	—	—	H7	3
* D352A	* E052A	7/16	14	—	—	H11	3
D3543	E0543	7/16	—	20	—	H3	3
D3545	E0545	7/16	—	20	—	H5	3
* D3547	* E0547	7/16	—	20	—	H7	3

EDP No.	SIZE		Thread Per Inch			Limit	No. of Flute
	Steam Oxide	Hardslick	UNC	UNF	8 Pitch		
* D354A	* E054A	7/16	—	20	—	H11	3
D3563	E0563	1/2	13	—	—	H3	3
D3565	E0565	1/2	13	—	—	H5	3
* D3567	* E0567	1/2	13	—	—	H7	3
* D356A	* E056A	1/2	13	—	—	H11	3
D3583	E0583	1/2	—	20	—	H3	3
D3585	E0585	1/2	—	20	—	H5	3
* D3587	* E0587	1/2	—	20	—	H7	3
* D358A	* E058A	1/2	—	20	—	H11	3
* D3603	* E0603	9/16	12	—	—	H3	4
* D3623	* E0623	9/16	—	18	—	H3	4
D3643	E0643	5/8	11	—	—	H3	4
D3645	E0645	5/8	11	—	—	H5	4
D3663	E0663	5/8	—	18	—	H3	4
D3703	E0703	3/4	10	—	—	H3	4
D3705	E0705	3/4	10	—	—	H5	4
D3723	E0723	3/4	—	16	—	H3	4
D3725	E0725	3/4	—	16	—	H5	4
* D3745	* E0745	7/8	9	—	—	H5	4
* D3764	* E0764	7/8	—	14	—	H4	4
* D3785	* E0785	1	8	—	—	H5	4
D3804	E0804	1	—	12	—	H4	4
* D3826	* E0826	1-1/8	7	—	—	H6	4
* D3845	* E0845	1-1/8	—	12	—	H5	4
* D3836	* E0836	1-1/8	—	—	8	H6	4
* D3866	* E0866	1-1/4	7	—	—	H6	4
* D3885	* E0885	1-1/4	—	12	—	H5	4
* D3876	* E0876	1-1/4	—	—	8	H6	4
* D3906	* E0906	1-3/8	6	—	—	H6	4
* D3925	* E0925	1-3/8	—	12	—	H5	4
* D3916	* E0916	1-3/8	—	—	8	H6	4
* D3946	* E0946	1-1/2	6	—	—	H6	4
* D3965	* E0965	1-1/2	—	12	—	H5	4
* D3956	* E0956	1-1/2	—	—	8	H6	4

► For tapping depth on ANSI Length Taps, refer to MCTI 302 on page 197.

► For tapping depth on ANSI Length Taps, refer to MCTI 302 on page 197.

► Bright Finish Available: D4 Series

► Bright Finish Available: D4 Series

◎ : Excellent ○ : Good

◎ : Excellent ○ : Good

Low carbon steels / Free machining carbon steels	Medium to high carbon steels / Low alloyed steels	Steel castings & forgings / Heat-treatable alloy steels	Alloyed tool steels / Mold steels	Free machining stainless steels	Heat-and corrosionresistant stainless steels / Valve stainless steels	Stainless steel castings / Precipitation hardening stainless steels	Pure Aluminum / Aluminum alloys			
◎	◎	◎	◎	○	○	○	○			
Aluminum alloy castings	Grey cast iron	Nodular cast iron / Chilled cast iron / Meehanite iron / Ductile iron	718 & 625 INCO / Waspaloy / Hastelloy / Invar / Monel / Incoloy	718 Inconel / A286	Titanium	Pure and alloyed copper	Free machining brass / Alloyed brass	Bronze	Zinc	Magnesium
			○							

Low carbon steels / Free machining carbon steels	Medium to high carbon steels / Low alloyed steels	Steel castings & forgings / Heat-treatable alloy steels	Alloyed tool steels / Mold steels	Free machining stainless steels	Heat-and corrosionresistant stainless steels / Valve stainless steels	Stainless steel castings / Precipitation hardening stainless steels	Pure Aluminum / Aluminum alloys			
◎	◎	◎	◎	○	○	○	○			
Aluminum alloy castings	Grey cast iron	Nodular cast iron / Chilled cast iron / Meehanite iron / Ductile iron	718 & 625 INCO / Waspaloy / Hastelloy / Invar / Monel / Incoloy	718 Inconel / A286	Titanium	Pure and alloyed copper	Free machining brass / Alloyed brass	Bronze	Zinc	Magnesium
			○							

SPIRAL FLUTE TAPS

BU/BV SERIES

SPIRAL FLUTE TAPS

BU/BV SERIES

SPIRAL FLUTE TAPS MODIFIED BOTTOMING STYLE Steels up to 38HRc

SPIRAL FLUTE TAPS MODIFIED BOTTOMING STYLE Steels up to 38HRc

A variety of D Limit

A variety of D Limit

Hole type 2.5xD

Hole type 2.5xD

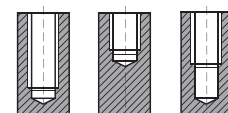

USCTI

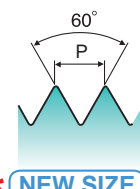

* NEW SIZE

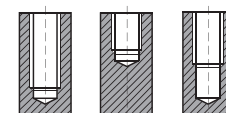

USCTI

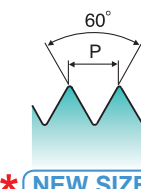

* NEW SIZE

VG HSSE-V3 M MF USCTI 302A D3~D11 60° 2P~3P Steam Oxide Hardslick R45

VG HSSE-V3 M MF USCTI 302A D3~D11 60° 2P~3P Steam Oxide Hardslick R45

EDP No.		SIZE	Pitch	Limit	No. of Flute
Steam Oxide	Hardslick				
BU203	BV203	M3	0.50	D3	3
* BU20A	* BV20A	M3	0.50	D11	3
BU224	BV224	M3.5	0.60	D4	3
* BU22A	* BV22A	M3.5	0.60	D11	3
BU244	BV244	M4	0.70	D4	3
* BU24A	* BV24A	M4	0.70	D11	3
BU284	BV284	M5	0.80	D4	3
* BU28A	* BV28A	M5	0.80	D11	3
BU315	BV315	M6	1.00	D5	3
* BU31A	* BV31A	M6	1.00	D11	3
BU345	BV345	M7	1.00	D5	3
* BU34A	* BV34A	M7	1.00	D11	3
BU375	BV375	M8	1.00	D5	3
* BU37A	* BV37A	M8	1.00	D11	3
BU365	BV365	M8	1.25	D5	3
* BU36A	* BV36A	M8	1.25	D11	3
* BU445	* BV445	M10	1.00	D5	3
* BU44A	* BV44A	M10	1.00	D11	3
BU435	BV435	M10	1.25	D5	3
* BU43A	* BV43A	M10	1.25	D11	3
BU426	BV426	M10	1.50	D6	3
* BU42A	* BV42A	M10	1.50	D11	3
BU525	BV525	M12	1.25	D5	3
* BU52A	* BV52A	M12	1.25	D11	3
* BU516	* BV516	M12	1.50	D6	3
* BU51A	* BV51A	M12	1.50	D11	3
BU506	BV506	M12	1.75	D6	3
* BU50A	* BV50A	M12	1.75	D11	3
BU556	BV556	M14	1.50	D6	3
BU547	BV547	M14	2.00	D7	3
BU616	BV616	M16	1.50	D6	3

EDP No.		SIZE	Pitch	Limit	No. of Flute
Steam Oxide	Hardslick				
BU607	BV607	M16	2.00	D7	3
BU676	BV676	M18	1.50	D6	4
BU657	BV657	M18	2.50	D7	4
* BU726	* BV726	M20	1.50	D6	4
* BU708	* BV708	M20	2.50	D8	4
* BU766	* BV766	M22	1.50	D6	4
* BU748	* BV748	M22	2.50	D8	4
* BU806	* BV806	M24	1.50	D6	4
* BU788	* BV788	M24	3.00	D8	4
* BU886	* BV886	M27	1.50	D6	4
* BU868	* BV868	M27	3.00	D8	4
* BU976	* BV976	M30	1.50	D6	4
* BU949	* BV949	M30	3.50	D9	4

► For tapping depth on ANSI Length Taps, refer to MCTI 302 on page 198.

► For tapping depth on ANSI Length Taps, refer to MCTI 302 on page 198.

► NEXT PAGE

◎ : Excellent ○ : Good

◎ : Excellent ○ : Good

Low carbon steels/ Free machining carbon steels	Medium to high carbon steels/ Low alloyed steels	Steel castings & forgings / Heat-treatable alloy steels	Alloyed tool steels / Mold steels	Free machining stainless steels	Heat-and corrosionresistant stainless steels / Valve stainless steels	Stainless steel castings / Precipitation hardening stainless steels	Pure Aluminum/ Aluminum alloys														
Aluminum alloy castings	Grey cast iron	Nodular cast iron / Chilled cast iron / Meehanite iron / Ductile iron	718 & 625 INCO / Waspaloy / Hastelloy / Invar / Monel / Incoloy	718 Inconel / A286	Titanium	Pure and alloyed copper	Free machining brass / Alloyed brass	Bronze	Zinc	Magnesium											

Low carbon steels/ Free machining carbon steels	Medium to high carbon steels/ Low alloyed steels	Steel castings & forgings / Heat-treatable alloy steels	Alloyed tool steels / Mold steels	Free machining stainless steels	Heat-and corrosionresistant stainless steels / Valve stainless steels	Stainless steel castings / Precipitation hardening stainless steels	Pure Aluminum/ Aluminum alloys														
Aluminum alloy castings	Grey cast iron	Nodular cast iron / Chilled cast iron / Meehanite iron / Ductile iron	718 & 625 INCO / Waspaloy / Hastelloy / Invar / Monel / Incoloy	718 Inconel / A286	Titanium	Pure and alloyed copper	Free machining brass / Alloyed brass	Bronze	Zinc	Magnesium											

SPIRAL FLUTE TAPS

E2/E4/E5 SERIES

SPIRAL FLUTE TAPS

C0/D8 SERIES

SPIRAL FLUTE TAPS MODIFIED BOTTOMING STYLE Steels up to 38HRc

SPIRAL FLUTE TAPS MODIFIED BOTTOMING STYLE for Aluminum Alloys or Die Cast Aluminum

Hole type 2.5xD

Hole type 2.5xD

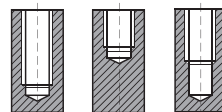

DIN-ANSI Shank

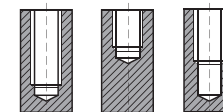
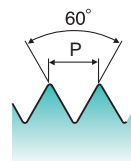

USCTI

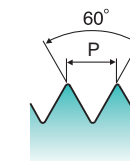

VG HSSE-V3 M MF D3-D7 60° 2P~3P Steam Oxide TiCN Hardslick R45

AI HSSE-V3 UNC UNF USCTI 302A H2-H5 60° 2P~3P Bright Hardslick R50 ◇ Call for Availability

	EDP No.			SIZE	Pitch	Limit	No. of Flute
	Steam Oxide	TiCN	Hardslick				
	E2203	E4203	E5203	M3	0.5	D3	3
	E2224	E4224	E5224	M3.5	0.6	D4	3
	E2244	E4244	E5244	M4	0.7	D4	3
	E2284	E4284	E5284	M5	0.8	D4	3
	E2315	E4315	E5315	M6	1.0	D5	3
	E2345	E4345	E5345	M7	1.0	D5	3
	E2365	E4365	E5365	M8	1.25	D5	3
	E2375	E4375	E5375	M8	1.0	D5	3
	E2426	E4426	E5426	M10	1.5	D6	3
	E2435	E4435	E5435	M10	1.25	D5	3
	E2506	E4506	E5506	M12	1.75	D6	3
	E2525	E4525	E5525	M12	1.25	D5	3
	E2547	E4547	E5547	M14	2.0	D7	3
	E2556	E4556	E5556	M14	1.5	D6	3
	E2607	E4607	E5607	M16	2.0	D7	3
	E2616	E4616	E5616	M16	1.5	D6	3
	E2657	E4657	E5657	M18	2.5	D7	4
	E2676	E4676	E5676	M18	1.5	D6	4

► For tapping depth on DIN / ANSI Shank Taps, refer to DIN Table on page 199 & 200.

	EDP No.		SIZE	Thread Per Inch		Limit	No. of Flute
	Bright	Hardslick		UNC	UNF		
	C0162	D8162	4	40	—	H2	2
	◇ C0163	D8163	4	40	—	H3	2
	C0242	D8242	6	32	—	H2	2
	C0243	D8243	6	32	—	H3	2
	◇ C0282	D8282	8	32	—	H2	2
	C0283	D8283	8	32	—	H3	2
	C0323	D8323	10	24	—	H3	2
	◇ C0342	D8342	10	32	—	H2	2
	C0343	D8343	10	—	32	H3	2
	◇ C0345	D8345	10	—	32	H5	2
	C0403	D8403	1/4	20	—	H3	2
	C0405	D8405	1/4	20	—	H5	2
	C0423	D8423	1/4	—	28	H3	2
	C0443	D8443	5/16	18	—	H3	2
	C0445	D8445	5/16	18	—	H5	2
	C0463	D8463	5/16	—	24	H3	2
	C0465	D8465	5/16	—	24	H5	2
	C0483	D8483	3/8	16	—	H3	2
	C0485	D8485	3/8	16	—	H5	2
	C0503	D8503	3/8	—	24	H3	2
	C0505	D8505	3/8	—	24	H5	2
	◇ C0563	D8563	1/2	13	—	H3	2
	◇ C0565	D8565	1/2	13	—	H5	2
	◇ C0583	D8583	1/2	—	20	H3	2
	◇ C0643	D8643	5/8	11	—	H3	3
	◇ C0663	D8663	5/8	—	18	H3	3
	◇ C0703	D8703	3/4	10	—	H3	3
	◇ C0723	D8723	3/4	—	16	H3	3
	◇ C0744	D8744	7/8	9	—	H4	3
	◇ C0764	D8764	7/8	—	14	H4	3
	◇ C0784	D8784	1	8	—	H4	3

► For tapping depth on ANSI Length Taps, refer to MCTI 302 on page 197.

◎ : Excellent ○ : Good

Low carbon steels/ Free machining carbon steels	Medium to high carbon steels/ Low alloyed steels	Steel castings & forgings / Heat-treatable alloy steels	Alloyed tool steels / Mold steels	Free machining stainless steels	Heat-and corrosionresistant stainless steels / Valve stainless steels	Stainless steel castings / Precipitation hardening stainless steels	Pure Aluminum/ Aluminum alloys			
◎	◎	◎	◎	○	○	◎	◎			
Aluminum alloy castings	Grey cast iron	Nodular cast iron / Chilled cast iron / Meehanite iron / Ductile iron	718 & 625 INCO / Waspaloy / Hastelloy / Invar / Monel / Incoloy	718 Inconel / A286	Titanium	Pure and alloyed copper	Free machining brass / Alloyed brass	Bronze	Zinc	Magnesium
◎			○							

◎ : Excellent ○ : Good

Low carbon steels/ Free machining carbon steels	Medium to high carbon steels/ Low alloyed steels	Steel castings & forgings / Heat-treatable alloy steels	Alloyed tool steels / Mold steels	Free machining stainless steels	Heat-and corrosionresistant stainless steels / Valve stainless steels	Stainless steel castings / Precipitation hardening stainless steels	Pure Aluminum/ Aluminum alloys			
◎	◎	◎	◎	○	○	◎	◎			
Aluminum alloy castings	Grey cast iron	Nodular cast iron / Chilled cast iron / Meehanite iron / Ductile iron	718 & 625 INCO / Waspaloy / Hastelloy / Invar / Monel / Incoloy	718 Inconel / A286	Titanium	Pure and alloyed copper	Free machining brass / Alloyed brass	Bronze	Zinc	Magnesium
◎										

SPIRAL FLUTE TAPS

BW/BX SERIES

SPIRAL FLUTE TAPS

C2/C3/C4/D9 SERIES

SPIRAL FLUTE TAPS MODIFIED BOTTOMING STYLE for Aluminum Alloys or Die Cast Aluminum

STANDARD TAPS : SPIRAL FLUTE TAPS BOTTOMING STYLE for General Purpose

Hole type 2.5xD

Hole type 2.5xD

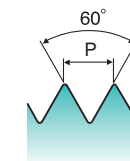
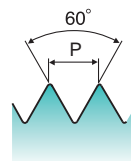
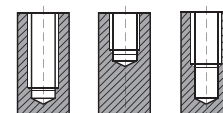
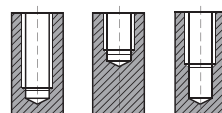

USCTI

USCTI

AI HSSE-V3 M MF USCTI 302A D3~D6 60° 2P~3P Bright Hardslick R50 Call for Availability

GS HSSE-V3 UNC UNF USCTI 302 H2~H6 60° 1.5P~2P Steam Oxide Bright TiN Hardslick R45

EDP No.	SIZE	Pitch	Thread Limit	No. of Flute	
					Bright
BW203	BX203	M3	0.5	D3	2
BW244	BX244	M4	0.7	D4	2
BW285	BX285	M5	0.8	D5	2
BW315	BX315	M6	1.0	D5	2
BW365	BX365	M8	1.25	D5	2
BW426	BX426	M10	1.50	D6	2
BW435	BX435	M10	1.25	D5	2
◇ BW506	BX506	M12	1.75	D6	2
◇ BW515	BX515	M12	1.50	D5	2
◇ BW525	BX525	M12	1.25	D5	2

► DIN Length available: Bright Finish F1 Series & Hardslick coated F3 Series
 ► For tapping depth on ANSI Length Taps, refer to MCTI 302 on page 198.

EDP No.	SIZE	Thread Per Inch	Limit	No. of Flute				
					UNC	UNF		
C2162	C3162	C4162	D9162	4	40	—	H2	2
C2202	C3202	C4202	D9202	5	40	—	H2	3
C2243	C3243	C4243	D9243	6	32	—	H3	3
C2283	C3283	C4283	D9283	8	32	—	H3	3
C2323	C3323	C4323	D9323	10	24	—	H3	3
C2343	C3343	C4343	D9343	10	—	32	H3	3
C2403	C3403	C4403	D9403	1/4	20	—	H3	3
C2405	C3405	C4405	D9405	1/4	20	—	H5	3
C2423	C3423	C4423	D9423	1/4	—	28	H3	3
C2443	C3443	C4443	D9443	5/16	18	—	H3	3
C2445	C3445	C4445	D9445	5/16	18	—	H5	3
C2463	C3463	C4463	D9463	5/16	—	24	H3	3
C2483	C3483	C4483	D9483	3/8	16	—	H3	3
C2485	C3485	C4485	D9485	3/8	16	—	H5	3
C2503	C3503	C4503	D9503	3/8	—	24	H3	3
C2523	C3523	C4523	D9523	7/16	14	—	H3	3
C2525	C3525	C4525	D9525	7/16	14	—	H5	3
C2543	C3543	C4543	D9543	7/16	—	20	H3	3
C2545	C3545	C4545	D9545	7/16	—	20	H5	3
C2563	C3563	C4563	D9563	1/2	13	—	H3	3
C2565	C3565	C4565	D9565	1/2	13	—	H5	3
C2583	C3583	C4583	D9583	1/2	—	20	H3	3
C2585	C3585	C4585	D9585	1/2	—	20	H5	3
C2605	C3605	C4605	D9605	9/16	12	—	H5	3
C2625	C3625	C4625	D9625	9/16	—	18	H5	3
C2643	C3643	C4643	D9643	5/8	11	—	H3	4
C2645	C3645	C4645	D9645	5/8	11	—	H5	4
C2663	C3663	C4663	D9663	5/8	—	18	H3	4
C2703	C3703	C4703	D9703	3/4	10	—	H3	4
C2705	C3705	C4705	D9705	3/4	10	—	H5	4
C2723	C3723	C4723	D9723	3/4	—	16	H3	4
C2744	C3744	C4744	D9744	7/8	9	—	H4	4
C2766	C3766	C4766	D9766	7/8	—	14	H6	4
C2784	C3784	C4784	D9784	1	8	—	H4	4

► For tapping depth on ANSI Length Taps, refer to MCTI 302 on page 201.

© : Excellent ○ : Good

Low carbon steels/Free machining carbon steels	Medium to high carbon steels/Low alloyed steels	Steel castings & forgings/Heat-treatable alloy steels	Alloyed tool steels/Mold steels	Free machining stainless steels	Heat-and corrosionresistant stainless steels/Valve stainless steels	Stainless steel castings/Precipitation hardening stainless steels	Pure Aluminum/Aluminum alloys			
○	○	○	○	○	○	○	○			
Aluminum alloy castings	Grey cast iron	Nodular cast iron/Chilled cast iron/Meehanite iron/Ductile iron	718 & 625 INCO/Waspaloy/Hastelloy/Invar/Monel/Incoloy	718 Inconel/A286	Titanium	Pure and alloyed copper	Free machining brass/Alloyed brass	Bronze	Zinc	Magnesium
○	○	○	○	○	○	○	○	○	○	○

© : Excellent ○ : Good

Low carbon steels/Free machining carbon steels	Medium to high carbon steels/Low alloyed steels	Steel castings & forgings/Heat-treatable alloy steels	Alloyed tool steels/Mold steels	Free machining stainless steels	Heat-and corrosionresistant stainless steels/Valve stainless steels	Stainless steel castings/Precipitation hardening stainless steels	Pure Aluminum/Aluminum alloys			
○	○	○	○	○	○	○	○			
Aluminum alloy castings	Grey cast iron	Nodular cast iron/Chilled cast iron/Meehanite iron/Ductile iron	718 & 625 INCO/Waspaloy/Hastelloy/Invar/Monel/Incoloy	718 Inconel/A286	Titanium	Pure and alloyed copper	Free machining brass/Alloyed brass	Bronze	Zinc	Magnesium
○	○	○	○	○	○	○	○	○	○	○

SPIRAL FLUTE TAPS

F4/F8/F6 SERIES

SPIRAL FLUTE TAPS

F4/F8/F6 SERIES

SPIRAL FLUTE TAPS BOTTOMING STYLE for General Purpose

SPIRAL FLUTE TAPS BOTTOMING STYLE for General Purpose

Hole type 2.5xD

Hole type 2.5xD

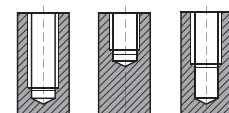
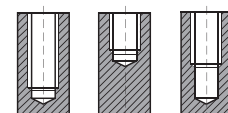

USCTI



USCTI

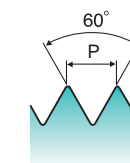
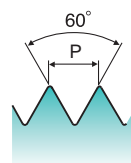

GS HSS-V UNC UNF USCTI 302A H2-H6 60° 1.5P~2P Steam Oxide TiN Hardslick R50

GS HSS-V UNC UNF USCTI 302A H2-H6 60° 1.5P~2P Steam Oxide TiN Hardslick R50

EDP No.	Thread Per Inch			Limit	No. of Flute		
	UNC	UNF	Limit				
F4082	F8082	F6082	2	56	—	H2	2
F4162	F8162	F6162	4	40	—	H2	2
F4202	F8202	F6202	5	40	—	H2	2
F4243	F8243	F6243	6	32	—	H3	3
F4283	F8283	F6283	8	32	—	H3	3
F4323	F8323	F6323	10	24	—	H3	3
F4343	F8343	F6343	10	—	32	H3	3
F4403	F8403	F6403	1/4	20	—	H3	3
F4405	F8405	F6405	1/4	20	—	H5	3
F4423	F8423	F6423	1/4	—	28	H3	3
F4443	F8443	F6443	5/16	18	—	H3	3
F4445	F8445	F6445	5/16	18	—	H5	3
F4463	F8463	F6463	5/16	—	24	H3	3
F4483	F8483	F6483	3/8	16	—	H3	3
F4485	F8485	F6485	3/8	16	—	H5	3
F4503	F8503	F6503	3/8	—	24	H3	3
F4523	F8523	F6523	7/16	14	—	H3	3
F4525	F8525	F6525	7/16	14	—	H5	3
F4543	F8543	F6543	7/16	—	20	H3	3
F4545	F8545	F6545	7/16	—	20	H5	3
F4563	F8563	F6563	1/2	13	—	H3	3
F4565	F8565	F6565	1/2	13	—	H5	3
F4583	F8583	F6583	1/2	—	20	H3	3
F4585	F8585	F6585	1/2	—	20	H5	3
F4603	F8603	F6603	9/16	12	—	H3	3
F4605	F8605	F6605	9/16	12	—	H5	3
F4623	F8623	F6623	9/16	—	18	H3	3

EDP No.	Thread Per Inch			Limit	No. of Flute		
	UNC	UNF	Limit				
F4625	F8625	F6625	9/16	—	18	H5	3
F4643	F8643	F6643	5/8	11	—	H3	4
F4645	F8645	F6645	5/8	11	—	H5	4
F4663	F8663	F6663	5/8	—	18	H3	4
F4665	F8665	F6665	5/8	—	18	H5	4
F4703	F8703	F6703	3/4	10	—	H3	4
F4705	F8705	F6705	3/4	10	—	H5	4
F4723	F8723	F6723	3/4	—	16	H3	4
F4725	F8725	F6725	3/4	—	16	H5	4
F4744	F8744	F6744	7/8	9	—	H4	4
F4746	F8746	F6746	7/8	9	—	H6	4
F4764	F8764	F6764	7/8	—	14	H4	4
F4766	F8766	F6766	7/8	—	14	H6	4
F4784	F8784	F6784	1	8	—	H4	4
F4786	F8786	F6786	1	8	—	H6	4
F4806	F8806	F6806	1	—	12	H6	4

► For tapping depth on ANSI Length Taps, refer to MCTI 302 on page 197.

► For tapping depth on ANSI Length Taps, refer to MCTI 302 on page 197.

► NEXT PAGE

◎ : Excellent ○ : Good

Low carbon steels / Free machining carbon steels	Medium to high carbon steels / Low alloyed steels	Steel castings & forgings / Heat-treatable alloy steels	Alloyed tool steels / Mold steels	Free machining stainless steels	Heat-and corrosionresistant stainless steels / Valve stainless steels	Stainless steel castings / Precipitation hardening stainless steels	Pure Aluminum / Aluminum alloys			
◎	◎	○		○	○					
Aluminum alloy castings	Grey cast iron	Nodular cast iron / Chilled cast iron / Meehanite iron / Ductile iron	718 & 625 INCO / Waspaloy / Hastelloy / Invar / Monel / Incoloy	718 Inconel / A286	Titanium	Pure and alloyed copper	Free machining brass / Alloyed brass	Bronze	Zinc	Magnesium
○		○								

◎ : Excellent ○ : Good

Low carbon steels / Free machining carbon steels	Medium to high carbon steels / Low alloyed steels	Steel castings & forgings / Heat-treatable alloy steels	Alloyed tool steels / Mold steels	Free machining stainless steels	Heat-and corrosionresistant stainless steels / Valve stainless steels	Stainless steel castings / Precipitation hardening stainless steels	Pure Aluminum / Aluminum alloys			
◎	◎	○		○	○					
Aluminum alloy castings	Grey cast iron	Nodular cast iron / Chilled cast iron / Meehanite iron / Ductile iron	718 & 625 INCO / Waspaloy / Hastelloy / Invar / Monel / Incoloy	718 Inconel / A286	Titanium	Pure and alloyed copper	Free machining brass / Alloyed brass	Bronze	Zinc	Magnesium
○		○								

SPIRAL FLUTE TAPS

G4/G5/G6 SERIES

SPIRAL FLUTE TAPS BOTTOMING STYLE for General Purpose

Hole type 2.5xD

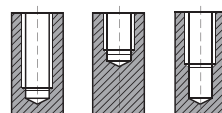

USCTI

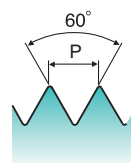

GS HSS-V M MF USCTI 302A D3~D6 60° 1.5P~2P Bright TiCN Hardslick R50

	EDP No.			SIZE	Pitch	Limit	No. of Flute
	Bright	TiCN	Hardslick				
	G4203	G5203	G6203	M3	0.5	D3	2
	G4224	G5224	G6224	M3.5	0.6	D4	2
	G4244	G5244	G6244	M4	0.7	D4	3
	G4284	G5284	G6284	M5	0.8	D4	3
	G4315	G5315	G6315	M6	1.0	D5	3
	G4345	G5345	G6345	M7	1.0	D5	3
	G4365	G5365	G6365	M8	1.25	D5	3
	G4375	G5375	G6375	M8	1.0	D5	3
	G4426	G5426	G6426	M10	1.5	D6	3
	G4435	G5435	G6435	M10	1.25	D5	3
	G4506	G5506	G6506	M12	1.75	D6	3
	G4525	G5525	G6525	M12	1.25	D5	3

► For tapping depth on ANSI Length Taps, refer to MCTI 302 on page 198.

◎ : Excellent ○ : Good

Low carbon steels / Free machining carbon steels	Medium to high carbon steels / Low alloyed steels	Steel castings & forgings / Heat-treatable alloy steels	Alloyed tool steels / Mold steels	Free machining stainless steels	Heat-and corrosionresistant stainless steels / Valve stainless steels	Stainless steel castings / Precipitation hardening stainless steels	Pure Aluminum / Aluminum alloys			
◎	◎	○		○	○					
Aluminum alloy castings	Grey cast iron	Nodular cast iron / Chilled cast iron / Meehanite iron / Ductile iron	718 & 625 INCO / Waspaloy / Hastelloy / Invar / Monel / Incoloy	718 Inconel / A286	Titanium	Pure and alloyed copper	Free machining brass / Alloyed brass	Bronze	Zinc	Magnesium
○		○								

SPIRAL FLUTE TAPS

G0/G1/G2 SERIES

SPIRAL FLUTE TAPS BOTTOMING STYLE for General Purpose

Hole type 2.5xD

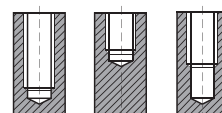

DIN-ANSI Shank

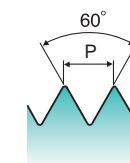

GS HSS-V UNC UNF H2~H6 60° 2P~3P Bright TiN Hardslick R45

	EDP No.			SIZE	Thread Per Inch		Limit	No. of Flute
	Bright	TiN	Hardslick		UNC	UNF		
	G0082	G1082	G2082	2	56	—	H2	2
	G0162	G1162	G2162	4	40	—	H2	2
	G0202	G1202	G2202	5	40	—	H2	3
	G0243	G1243	G2243	6	32	—	H3	3
	G0283	G1283	G2283	8	32	—	H3	3
	G0323	G1323	G2323	10	24	—	H3	3
	G0343	G1343	G2343	10	—	32	H3	3
	G0403	G1403	G2403	1/4	20	—	H3	3
	G0405	G1405	G2405	1/4	20	—	H5	3
	G0423	G1423	G2423	1/4	—	28	H3	3
	G0443	G1443	G2443	5/16	18	—	H3	3
	G0445	G1445	G2445	5/16	18	—	H5	3
	G0463	G1463	G2463	5/16	—	24	H3	3
	G0483	G1483	G2483	3/8	16	—	H3	3
	G0485	G1485	G2485	3/8	16	—	H5	3
	G0503	G1503	G2503	3/8	—	24	H3	3
	G0523	G1523	G2523	7/16	14	—	H3	3
	G0525	G1525	G2525	7/16	14	—	H5	3
	G0543	G1543	G2543	7/16	—	20	H3	3
	G0545	G1545	G2545	7/16	—	20	H5	3
	G0563	G1563	G2563	1/2	13	—	H3	3
	G0565	G1565	G2565	1/2	13	—	H5	3
	G0583	G1583	G2583	1/2	—	20	H3	3
	G0585	G1585	G2585	1/2	—	20	H5	3
	G0603	G1603	G2603	9/16	12	—	H3	3
	G0605	G1605	G2605	9/16	12	—	H5	3
	G0623	G1623	G2623	9/16	—	18	H3	3

► For tapping depth on DIN / ANSI Shank Taps, refer to DIN Table on page 199 & 200.

► NEXT PAGE

◎ : Excellent ○ : Good

Low carbon steels / Free machining carbon steels	Medium to high carbon steels / Low alloyed steels	Steel castings & forgings / Heat-treatable alloy steels	Alloyed tool steels / Mold steels	Free machining stainless steels	Heat-and corrosionresistant stainless steels / Valve stainless steels	Stainless steel castings / Precipitation hardening stainless steels	Pure Aluminum / Aluminum alloys			
◎	◎	○		○	○					
Aluminum alloy castings	Grey cast iron	Nodular cast iron / Chilled cast iron / Meehanite iron / Ductile iron	718 & 625 INCO / Waspaloy / Hastelloy / Invar / Monel / Incoloy	718 Inconel / A286	Titanium	Pure and alloyed copper	Free machining brass / Alloyed brass	Bronze	Zinc	Magnesium
○		○								

SPIRAL FLUTE TAPS

G0/G1/G2 SERIES

SPIRAL FLUTE TAPS

T7A96/T6A96/T8A96 SERIES
T7295/T6295/T8295 SERIES

SPIRAL FLUTE TAPS BOTTOMING STYLE for General Purpose

STANDARD TAPS : SPIRAL FLUTE TAPS for General Purpose

Hole type 2.5xD

Hole type 2.5xD

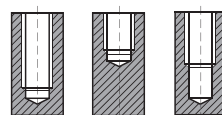

DIN-ANSI Shank

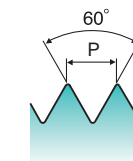
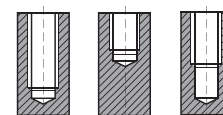
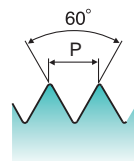

GS HSS-V UNC UNF H2-H6 60° 2P~3P Bright TiN Hardslick R45

GS HSS UNC UNF USCTI 302 H2-H5 60° 4P~5P Plug 1.5P~2P Bottoming Bright Steam Oxide TiN R50

	EDP No.			SIZE	Thread Per Inch		Limit	No. of Flute
	Bright	TiN	Hardslick		UNC	UNF		
G0625	G1625	G2625	9/16	—	18	H5	3	
G0643	G1643	G2643	5/8	11	—	H3	4	
G0645	G1645	G2645	5/8	11	—	H5	4	
G0663	G1663	G2663	5/8	—	18	H3	4	
G0665	G1665	G2665	5/8	—	18	H5	4	
G0703	G1703	G2703	3/4	10	—	H3	4	
G0705	G1705	G2705	3/4	10	—	H5	4	
G0723	G1723	G2723	3/4	—	16	H3	4	
G0725	G1725	G2725	3/4	—	16	H5	4	
G0746	G1746	G2746	7/8	9	—	H6	4	
G0764	G1764	G2764	7/8	—	14	H4	4	
G0766	G1766	G2766	7/8	—	14	H6	4	
G0786	G1786	G2786	1	8	—	H6	4	
G0804	G1804	G2804	1	—	12	H4	4	
G0806	G1806	G2806	1	—	12	H6	4	

► For tapping depth on DIN / ANSI Shank Taps, refer to DIN Table on page 199 & 200.

	EDP No.						SIZE	Thread Per Inch		Limit	No. of Flute
	Plug			Bottom				UNC	UNF		
	Bright	Steam Oxide	TiN	Bright	Steam Oxide	TiN					
T7A96122	T6A96122	T8A96122	T7295122	T6295122	T8295122	3	48	—	H2	2	
T7A96162	T6A96162	T8A96162	T7295162	T6295162	T8295162	4	40	—	H2	2	
T7A96202	T6A96202	T8A96202	T7295202	T6295202	T8295202	5	40	—	H2	2	
T7A96242	T6A96242	T8A96242	T7295242	T6295242	T8295242	6	32	—	H2	2	
T7A96243	T6A96243	T8A96243	T7295243	T6295243	T8295243	6	32	—	H3	2	
T7A96282	T6A96282	T8A96282	T7295282	T6295282	T8295282	8	32	—	H2	3	
T7A96283	T6A96283	T8A96283	T7295283	T6295283	T8295283	8	32	—	H3	3	
T7A96323	T6A96323	T8A96323	T7295323	T6295323	T8295323	10	24	—	H3	3	
T7A96342	T6A96342	T8A96342	T7295342	T6295342	T8295342	10	—	32	H2	3	
T7A96343	T6A96343	T8A96343	T7295343	T6295343	T8295343	10	—	32	H3	3	
T7A96363	T6A96363	T8A96363	T7295363	T6295363	T8295363	12	24	—	H3	3	
T7A96403	T6A96403	T8A96403	T7295403	T6295403	T8295403	1/4	20	—	H3	3	
T7A96405	T6A96405	T8A96405	T7295405	T6295405	T8295405	1/4	20	—	H5	3	
T7A96423	T6A96423	T8A96423	T7295423	T6295423	T8295423	1/4	—	28	H3	3	
T7A96443	T6A96443	T8A96443	T7295443	T6295443	T8295443	5/16	18	—	H3	3	
T7A96445	T6A96445	T8A96445	T7295445	T6295445	T8295445	5/16	18	—	H5	3	
T7A96463	T6A96463	T8A96463	T7295463	T6295463	T8295463	5/16	—	24	H3	3	
T7A96483	T6A96483	T8A96483	T7295483	T6295483	T8295483	3/8	16	—	H3	3	
T7A96485	T6A96485	T8A96485	T7295485	T6295485	T8295485	3/8	16	—	H5	3	
T7A96503	T6A96503	T8A96503	T7295503	T6295503	T8295503	3/8	—	24	H3	3	
T7A96523	T6A96523	T8A96523	T7295523	T6295523	T8295523	7/16	14	—	H3	3	
—	—	—	T7295525	T6295525	T8295525	7/16	14	—	H5	3	
T7A96543	T6A96543	T8A96543	T7295543	T6295543	T8295543	7/16	—	20	H3	3	
T7A96563	T6A96563	T8A96563	T7295563	T6295563	T8295563	1/2	13	—	H3	3	
T7A96565	T6A96565	T8A96565	T7295565	T6295565	T8295565	1/2	13	—	H5	3	
T7A96583	T6A96583	T8A96583	T7295583	T6295583	T8295583	1/2	—	20	H3	3	
T7A96643	T6A96643	T8A96643	T7295643	T6295643	T8295643	5/8	11	—	H3	4	
T7A96663	T6A96663	T8A96663	T7295663	T6295663	T8295663	5/8	—	18	H3	4	
T7A96703	T6A96703	T8A96703	T7295703	T6295703	T8295703	3/4	10	—	H3	4	
T7A96723	T6A96723	T8A96723	T7295723	T6295723	T8295723	3/4	—	16	H3	4	

► For tapping depth on ANSI Length Taps, refer to MCTI 302 on page 201.

◎ : Excellent ○ : Good

Low carbon steels/ Free machining carbon steels	Medium to high carbon steels/ Low alloyed steels	Steel castings & forgings / Heat-treatable alloy steels	Alloyed tool steels / Mold steels	Free machining stainless steels	Heat-and corrosionresistant stainless steels / Valve stainless steels	Stainless steel castings / Precipitation hardening stainless steels	Pure Aluminum/ Aluminum alloys				
◎	◎	○		○	○						
Aluminum alloy castings	Grey cast iron	Nodular cast iron / Chilled cast iron / Meehanite iron / Ductile iron	718 & 625 INCO / Waspaloy / Hastelloy / Invar / Monel / Incoloy	718 Inconel / A286	Titanium	Pure and alloyed copper	Free machining brass / Alloyed brass	Bronze	Zinc	Magnesium	
○		○									

◎ : Excellent ○ : Good

Low carbon steels/ Free machining carbon steels	Medium to high carbon steels/ Low alloyed steels	Steel castings & forgings / Heat-treatable alloy steels	Alloyed tool steels / Mold steels	Free machining stainless steels	Heat-and corrosionresistant stainless steels / Valve stainless steels	Stainless steel castings / Precipitation hardening stainless steels	Pure Aluminum/ Aluminum alloys				
◎	◎	○		○	○						
Aluminum alloy castings	Grey cast iron	Nodular cast iron / Chilled cast iron / Meehanite iron / Ductile iron	718 & 625 INCO / Waspaloy / Hastelloy / Invar / Monel / Incoloy	718 Inconel / A286	Titanium	Pure and alloyed copper	Free machining brass / Alloyed brass	Bronze	Zinc	Magnesium	
○		○									

YG SPIRAL FLUTE TAPS

T7A86/T6A86/T8A86 SERIES

T7A85/T6A85/T8A85 SERIES

YG SPIRAL FLUTE TAPS

T7D01/T8D01 SERIES

T7D02/T8D02 SERIES

STANDARD TAPS : METRIC SPIRAL FLUTE TAPS for General Purpose

SPIRAL FLUTE TAP, 6" EXTENSION

Hole type 2.5xD

Hole type 2.5xD

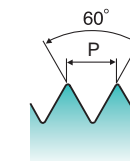
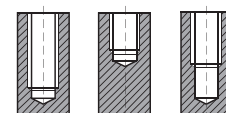
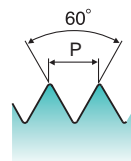
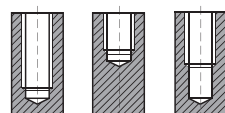

GS HSS M MF USCTI 302 D3~D6 60° 4P~5P Plug 1.5P~2P Bottoming Bright Steam Oxide TiN R50

GS HSS UNC UNF USCTI Long Shank H3 60° 4P~5P Plug 1.5P~2P Bottoming Bright TiN R50

EDP No.						SIZE	Pitch	Limit	No. of Flute
Plug			Bottom						
Bright	Steam Oxide	TiN	Bright	Steam Oxide	TiN				
T7A86203	T6A86203	T8A86203	T7A85203	T6A85203	T8A85203	M3	0.5	D3	2
T7A86244	T6A86244	T8A86244	T7A85244	T6A85244	T8A85244	M4	0.7	D4	3
T7A86284	T6A86284	T8A86284	T7A85284	T6A85284	T8A85284	M5	0.8	D4	3
T7A86315	T6A86315	T8A86315	T7A85315	T6A85315	T8A85315	M6	1.0	D5	3
T7A86365	T6A86365	T8A86365	T7A85365	T6A85365	T8A85365	M8	1.25	D5	3
T7A86426	T6A86426	T8A86426	T7A85426	T6A85426	T8A85426	M10	1.5	D6	3
T7A86506	T6A86506	T8A86506	T7A85506	T6A85506	T8A85506	M12	1.75	D6	3

EDP No.				SIZE	UNC	UNF	Thread Limit	Overall Length	No. of Flutes
Plug		Bottom							
Bright	TiN	Bright	TiN						
T7D01243	T8D01243	T7D02243	T8D02243	6	32	—	H3	6"	2
T7D01283	T8D01283	T7D02283	T8D02283	8	32	—	H3	6"	3
T7D01323	T8D01323	T7D02323	T8D02323	10	24	—	H3	6"	3
T7D01343	T8D01343	T7D02343	T8D02343	10	—	32	H3	6"	3
T7D01403	T8D01403	T7D02403	T8D02403	1/4	20	—	H3	6"	3
T7D01423	T8D01423	T7D02423	T8D02423	1/4	—	28	H3	6"	3
T7D01443	T8D01443	T7D02443	T8D02443	5/16	18	—	H3	6"	3
T7D01483	T8D01483	T7D02483	T8D02483	3/8	16	—	H3	6"	3
T7D01523	T8D01523	T7D02523	T8D02523	7/16	14	—	H3	6"	3
T7D01563	T8D01563	T7D02563	T8D02563	1/2	13	—	H3	6"	3
T7D01643	T8D01643	T7D02643	T8D02643	5/8	11	—	H3	6"	4

► For tapping depth on ANSI Length Taps, refer to MCTI 302 on page 201.

► For tapping depth on DIN / ANSI Shank Taps, refer to DIN Table on page 199 & 200.

◎ : Excellent ○ : Good

Low carbon steels / Free machining carbon steels	Medium to high carbon steels / Low alloyed steels	Steel castings & forgings / Heat-treatable alloy steels	Alloyed tool steels / Mold steels	Free machining stainless steels	Heat-and corrosionresistant stainless steels / Valve stainless steels	Stainless steel castings / Precipitation hardening stainless steels	Pure Aluminum / Aluminum alloys				
◎	◎	○		○	○						
Aluminum alloy castings	Grey cast iron	Nodular cast iron / Chilled cast iron / Meehanite iron / Ductile iron	718 & 625 INCO / Waspaloy / Hastelloy / Invar / Monel / Incoloy	718 Inconel / A286	Titanium	Pure and alloyed copper	Free machining brass / Alloyed brass	Bronze	Zinc	Magnesium	
○		○									

◎ : Excellent ○ : Good

Low carbon steels / Free machining carbon steels	Medium to high carbon steels / Low alloyed steels	Steel castings & forgings / Heat-treatable alloy steels	Alloyed tool steels / Mold steels	Free machining stainless steels	Heat-and corrosionresistant stainless steels / Valve stainless steels	Stainless steel castings / Precipitation hardening stainless steels	Pure Aluminum / Aluminum alloys				
◎	◎	○		○	○						
Aluminum alloy castings	Grey cast iron	Nodular cast iron / Chilled cast iron / Meehanite iron / Ductile iron	718 & 625 INCO / Waspaloy / Hastelloy / Invar / Monel / Incoloy	718 Inconel / A286	Titanium	Pure and alloyed copper	Free machining brass / Alloyed brass	Bronze	Zinc	Magnesium	
○		○									



Being the best through innovation

HSS



SPIRAL POINT TAPS

- Tapping Through Holes / Super HSS, HSS-E, HSS-PM, HSS-V & HSS



Global Cutting Tool Leader **YG-1**

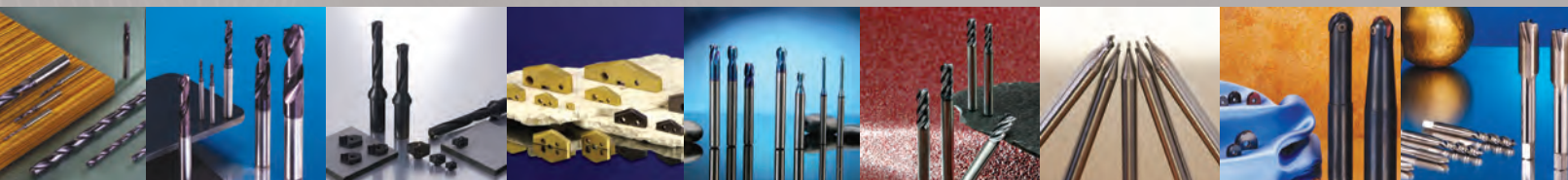

















SELECTION GUIDE

SPIRAL POINT TAPS

Tapping Through Holes / Super HSS, HSS-E, HSS-PM, HSS-V & HSS

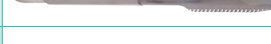
INCH

EDP No.	MODEL	Tool Material	Standard	Work Material	Dimensions	Tolerance	Chamfer	Thread Depth	Surface Treatment	Page
M9/O1		Super HSS	UNC/UNF	VG	USCTI 302A	H2~H6	4 ~ 5P	3.0D	Steam Oxide Hardslick	106
N7/N8		Super HSS	M/MF	VG	USCTI 302A	D3~D7	4 ~ 5P		Steam Oxide Hardslick	108
N4/O5		Super HSS	UNC/UNF	VG	DIN-ANSI Shank	H2~H6	4 ~ 5P		Steam Oxide Hardslick	109
N3/O3		Super HSS	M/MF	VG	DIN-ANSI Shank	D3~D7	4 ~ 5P		Steam Oxide Hardslick	110
M4/M6/M7		P-HSS	UNC/UNF	HR	USCTI 302A	H2~H5	4 ~ 5P		Steam Oxide TiCN Hardslick	111
TQ808/TK808/TR808		P-HSS	M/MF	HR	USCTI 302A	H2~H5	4 ~ 5P		Steam Oxide TiCN Hardslick	112
I3/I5/J6		P-HSS	UNC/UNF	Ti Ni	USCTI 302A	H2~H5	4 ~ 5P		Steam Oxide TiCN Hardslick	113
M2/M3		P-HSS	UNC/UNF	VA	USCTI Long Shank	H2~H3	4 ~ 5P		Hardslick	115
I0/I2/J2		HSSE-V3	UNC/UNF	VA	USCTI 302A	H2~H7	4 ~ 5P		Steam Oxide TiN Hardslick	116
O9/IA		HSSE-V3	M/MF	VA	USCTI 302A	D3~D7	4 ~ 5P		Steam Oxide Hardslick	119
K3/K5/K6		HSSE-V3	M/MF	VA	DIN-ANSI Shank	D3~D7	4 ~ 5P		Steam Oxide TiCN Hardslick	120
J3/J8		HSSE-V3	UNC/UNF	VG	USCTI 302A	H2~H11	4 ~ 5P		Steam Oxide Hardslick	121
IB/IC		HSSE-V3	M/MF	VG	USCTI 302A	D3~D11	4 ~ 5P		Steam Oxide Hardslick	125
J9/K7/K2		HSSE-V3	M/MF	VG	DIN-ANSI Shank	D3~D7	4 ~ 5P		Steam Oxide TiCN Hardslick	127
T2496		HSSE-V3	UNC/UNF	AI	USCTI 302A	H2~H5	4 ~ 5P		Bright	128
T2K01		HSSE-V3	M/MF	AI	USCTI 302A	D3~D6	4 ~ 5P		Bright	129
I9/J0/J1/J7		HSSE-V3	UNC/UNF	GS	USCTI	H2~H6	4 ~ 5P	Steam Oxide Bright/TiN Hardslick	130	
K9/L0/L1		HSS-V	UNC/UNF	GS	USCTI 302A	H2~H6	4 ~ 5P	Bright TiN Hardslick	131	

EDP No.	MODEL	Tool Material	Standard	Work Material	Dimensions	Tolerance	Chamfer	Thread Depth	Surface Treatment	Page
L7/L8/L9		HSS-V	M/MF	GS	USCTI 302A	D3~D6	4 ~ 5P	3.0D	Bright TiCN Hardslick	132
L3/L4/L5		HSS-V	UNC/UNF	GS	DIN-ANSI Shank	H2~H6	4 ~ 5P		Bright TiN Hardslick	133
T7216/T6216/T8216		HSS	UNC/UNF	GS	USCTI 302	H1~H7	4 ~ 5P		Bright Finish Steam Oxide TiN	134
T7C16/T6C16/T8C16		HSS	UNC/UNF	GS	USCTI 302	H1~H7	1.5 ~ 2P		Bright Finish Steam Oxide	138
T7256/T6256		HSS	UNC/UNF	GS	USCTI 302	H1~H7	4 ~ 5P		Bright Finish Steam Oxide TiN	140
T7217/T6217/T8217		HSS	M/MF	GS	USCTI 302	D3~D7	4 ~ 5P		Bright Finish Steam Oxide TiN	141
T7226/T6226/T8226		HSS	UNC/UNF	GS	USCTI 302	+0.005" oversize	4 ~ 5P		Bright Finish Steam Oxide TiN	142
T7B17/T6B17/T8B17		HSS	M/MF	GS	USCTI 302	+0.127mm oversize	4 ~ 5P		Bright Finish Steam Oxide TiN	143
T7236/T6236/T8236		HSS	UNC/UNF	GS	USCTI Long Shank	H3	4 ~ 5P		Bright Finish Steam Oxide TiN	143
T7G36/T6G36/T8G36		HSS	UNC/UNF	GS	USCTI Long Shank	H3	4 ~ 5P		Bright Finish Steam Oxide TiN	143

SPIRAL POINT TAPS

M9/O1 SERIES

SPIRAL POINT TAPS

M9/O1 SERIES

SPIRAL POINT TAPS PLUG STYLE for Steels & Stainless Steels up to 35HRc

SPIRAL POINT TAPS PLUG STYLE for Steels & Stainless Steels up to 35HRc

Hole type 3.0xD

Hole type 3.0xD



USCTI

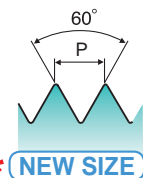

* NEW SIZE



USCTI

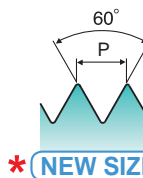

* NEW SIZE

VG
Super HSS
UNC UNF
USCTI 302A
H2-H6
60°
4P~5P
Steam Oxide
Hardslick

VG
Super HSS
UNC UNF
USCTI 302A
H2-H6
60°
4P~5P
Steam Oxide
Hardslick

EDP No.	Thread Per Inch	Limit	No. of Flute	SIZE	
				UNC	UNF
M9082	2	H2	2	56	—
M9162	4	H2	2	40	—
* M9163	4	H3	2	40	—
* M9164	4	H4	2	40	—
* M9165	4	H5	2	40	—
M9202	5	H2	3	40	—
* M9242	6	H2	3	32	—
M9243	6	H3	3	32	—
* M9244	6	H4	3	32	—
* M9245	6	H5	3	32	—
* M9246	6	H6	3	32	—
* M9282	8	H2	3	32	—
M9283	8	H3	3	32	—
* M9284	8	H4	3	32	—
* M9285	8	H5	3	32	—
* M9286	8	H6	3	32	—
M9323	10	H3	3	24	—
* M9325	10	H5	3	24	—
* M9342	10	H2	3	—	32
M9343	10	H3	3	—	32
* M9344	10	H4	3	—	32
* M9345	10	H5	3	—	32
* M9346	10	H6	3	—	32
M9403	1/4	H3	3	20	—
M9405	1/4	H5	3	20	—
M9423	1/4	H3	3	—	28
* M9424	1/4	H4	3	—	28
* M9425	1/4	H5	3	—	28
* M9426	1/4	H6	3	—	28
* M9443	5/16	H3	3	18	—
M9445	5/16	H5	3	18	—
* M9463	5/16	H3	3	—	24
M9464	5/16	H4	3	—	24

EDP No.	Thread Per Inch	Limit	No. of Flute	SIZE	
				UNC	UNF
* M9465	5/16	H5	3	—	24
* M9466	5/16	H6	3	—	24
* M9483	3/8	H3	3	16	—
M9485	3/8	H5	3	16	—
* M9503	3/8	H3	3	—	24
M9504	3/8	H4	3	—	24
* M9505	3/8	H5	3	—	24
* M9506	3/8	H6	3	—	24
* M9523	7/16	H3	3	14	—
M9525	7/16	H5	3	14	—
* M9543	7/16	H3	3	—	20
M9545	7/16	H5	3	—	20
* M9563	1/2	H3	3	13	—
M9565	1/2	H5	3	13	—
* M9583	1/2	H3	3	—	20
M9585	1/2	H5	3	—	20
M9605	9/16	H5	3	12	—
M9625	9/16	H5	3	—	18
* M9643	5/8	H3	3	11	—
M9645	5/8	H5	3	11	—
* M9663	5/8	H3	3	—	18
M9665	5/8	H5	3	—	18
* M9703	3/4	H3	3	10	—
M9705	3/4	H5	3	10	—
* M9723	3/4	H3	3	—	16
M9725	3/4	H5	3	—	16
M9746	7/8	H6	3	9	—
M9766	7/8	H6	3	—	14
M9786	1	H6	3	8	—
M9806	1	H6	3	—	12
M9836	1-1/8	H6	4	8	—
M9876	1-1/4	H6	4	8	—
M9916	1-3/8	H6	4	8	—
M9956	1-1/2	H6	4	8	—

► For tapping depth on ANSI Length Taps, refer to MCTI 302 on page 197.

► For tapping depth on ANSI Length Taps, refer to MCTI 302 on page 197.

© : Excellent ○ : Good

Low carbon steels/ Free machining carbon steels	Medium to high carbon steels/ Low alloyed steels	Steel castings & forgings / Heat-treatable alloy steels	Alloyed tool steels / Mold steels	Free machining stainless steels	Heat-and corrosionresistant stainless steels / Valve stainless steels	Stainless steel castings / Precipitation hardening stainless steels	Pure Aluminum/ Aluminum alloys			
○	◎	◎		◎	◎		○			
Aluminum alloy castings	Grey cast iron	Nodular cast iron / Chilled cast iron / Meehanite iron / Ductile iron	718 & 625 INCO / Waspaloy / Hastelloy / Invar / Monel / Incoloy	718 Inconel / A286	Titanium	Pure and alloyed copper	Free machining brass / Alloyed brass	Bronze	Zinc	Magnesium
					○	○			○	○

© : Excellent ○ : Good

Low carbon steels/ Free machining carbon steels	Medium to high carbon steels/ Low alloyed steels	Steel castings & forgings / Heat-treatable alloy steels	Alloyed tool steels / Mold steels	Free machining stainless steels	Heat-and corrosionresistant stainless steels / Valve stainless steels	Stainless steel castings / Precipitation hardening stainless steels	Pure Aluminum/ Aluminum alloys			
○	◎	◎		◎	◎		○			
Aluminum alloy castings	Grey cast iron	Nodular cast iron / Chilled cast iron / Meehanite iron / Ductile iron	718 & 625 INCO / Waspaloy / Hastelloy / Invar / Monel / Incoloy	718 Inconel / A286	Titanium	Pure and alloyed copper	Free machining brass / Alloyed brass	Bronze	Zinc	Magnesium
					○	○			○	○

SPIRAL POINT TAPS

N7/N8 SERIES

SPIRAL POINT TAPS

N4/O5 SERIES

METRIC SPIRAL POINT TAPS PLUG STYLE for Steels & Stainless Steels up to 35HRc

SPIRAL POINT TAPS PLUG STYLE for Steels & Stainless Steels up to 35HRc

Hole type 3.0xD

Hole type 3.0xD



USCTI

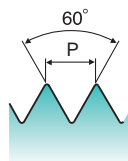

DIN-ANSI Shank

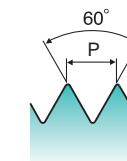

VG
Super HSS
M MF
USCTI 302A
D3~D7
4P~5P
Steam Oxide
Hardslick

VG
Super HSS
UNC UNF
H2~H6
4P~5P
Steam Oxide
Hardslick

EDP No.	SIZE	Pitch	Limit	No. of Flute
N7203	M3	0.5	D3	3
N7224	M3.5	0.6	D4	3
N7244	M4	0.7	D4	3
N7284	M5	0.8	D4	3
N7315	M6	1.0	D5	3
N7345	M7	1.0	D5	3
N7365	M8	1.25	D5	3
N7375	M8	1.0	D5	3
N7426	M10	1.5	D6	3
N7435	M10	1.25	D5	3
N7506	M12	1.75	D6	3
N7525	M12	1.25	D5	3
N7547	M14	2.0	D7	3
N7556	M14	1.5	D6	3
N7607	M16	2.0	D7	3
N7616	M16	1.5	D6	3
N7657	M18	2.5	D7	3
N7676	M18	1.5	D6	3

EDP No.	SIZE	Thread Per Inch		Limit	No. of Flute
		UNC	UNF		
N4082	2	56	—	H2	2
N4162	4	40	—	H2	2
N4202	5	40	—	H2	3
N4243	6	32	—	H3	3
N4283	8	32	—	H3	3
N4323	10	24	—	H3	3
N4343	10	—	32	H3	3
N4403	1/4	20	—	H3	3
N4405	1/4	20	—	H5	3
N4423	1/4	—	28	H3	3
N4445	5/16	18	—	H5	3
N4464	5/16	—	24	H4	3
N4485	3/8	16	—	H5	3
N4504	3/8	—	24	H4	3
N4525	7/16	14	—	H5	3
N4545	7/16	—	20	H5	3
N4565	1/2	13	—	H5	3
N4585	1/2	—	20	H5	3
N4605	9/16	12	—	H5	3
N4625	9/16	—	18	H5	3
N4645	5/8	11	—	H5	3
N4665	5/8	—	18	H5	3
N4705	3/4	10	—	H5	3
N4725	3/4	—	16	H5	3
N4746	7/8	9	—	H6	3
N4766	7/8	—	14	H6	3
N4786	1	8	—	H6	3
N4806	1	—	12	H6	3
N4836	1-1/8	8	—	H6	4
N4876	1-1/4	8	—	H6	4
N4916	1-3/8	8	—	H6	4
N4956	1-1/2	8	—	H6	4

► For tapping depth on ANSI Length Taps, refer to MCTI 302 on page 198.

► For tapping depth on DIN / ANSI Shank Taps, refer to DIN Table on page 199 & 200.

◎ : Excellent ○ : Good

Low carbon steels/ Free machining carbon steels	Medium to high carbon steels/ Low alloyed steels	Steel castings & forgings / Heat-treatable alloy steels	Alloyed tool steels / Mold steels	Free machining stainless steels	Heat-and corrosionresistant stainless steels / Valve stainless steels	Stainless steel castings / Precipitation hardening stainless steels	Pure Aluminum/ Aluminum alloys			
○	◎	◎		◎	◎		○			
Aluminum alloy castings	Grey cast iron	Nodular cast iron / Chilled cast iron / Meehanite iron / Ductile iron	718 & 625 INCO / Waspaloy / Hastelloy / Invar / Monel / Incoloy	718 Inconel / A286	Titanium	Pure and alloyed copper	Free machining brass / Alloyed brass	Bronze	Zinc	Magnesium
					○	○			○	○

◎ : Excellent ○ : Good

Low carbon steels/ Free machining carbon steels	Medium to high carbon steels/ Low alloyed steels	Steel castings & forgings / Heat-treatable alloy steels	Alloyed tool steels / Mold steels	Free machining stainless steels	Heat-and corrosionresistant stainless steels / Valve stainless steels	Stainless steel castings / Precipitation hardening stainless steels	Pure Aluminum/ Aluminum alloys			
○	◎	◎		◎	◎		○			
Aluminum alloy castings	Grey cast iron	Nodular cast iron / Chilled cast iron / Meehanite iron / Ductile iron	718 & 625 INCO / Waspaloy / Hastelloy / Invar / Monel / Incoloy	718 Inconel / A286	Titanium	Pure and alloyed copper	Free machining brass / Alloyed brass	Bronze	Zinc	Magnesium
					○	○			○	○

SPIRAL POINT TAPS

N3/O3 SERIES

SPIRAL POINT TAPS

M4/M6/M7 SERIES

METRIC SPIRAL POINT TAPS PLUG STYLE for Steels & Stainless Steels up to 35HRc

SPIRAL POINT TAPS PLUG STYLE Steels up to 45HRc

Hole type 3.0xD

Hole type 3.0xD



DIN-ANSI Shank

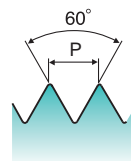

USCTI

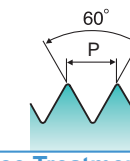

* New Surface Treatment

VG
Super HSS
M MF
D3-D7
4P~5P
Steam Oxide
Hardslick

HR
P-HSS
UNC UNF
USCTI 302A
H2-H5
4P~5P
Steam Oxide
TiCN
Hardslick

EDP No.	SIZE	Pitch	Limit	No. of Flute
N3203	M3	0.5	D3	3
N3224	M3.5	0.6	D4	3
N3244	M4	0.7	D4	3
N3284	M5	0.8	D4	3
N3315	M6	1.0	D5	3
N3345	M7	1.0	D5	3
N3365	M8	1.25	D5	3
N3375	M8	1.0	D5	3
N3426	M10	1.5	D6	3
N3435	M10	1.25	D5	3
N3506	M12	1.75	D6	3
N3525	M12	1.25	D5	3
N3547	M14	2.0	D7	3
N3556	M14	1.5	D6	3
N3607	M16	2.0	D7	3
N3616	M16	1.5	D6	3
N3657	M18	2.5	D7	3
N3676	M18	1.5	D6	3

EDP No.	SIZE	Thread Per Inch	Limit	No. of Flute
* M4082	2	56	H2	2
* M4162	4	40	H2	2
* M4202	5	40	H2	3
* M4243	6	32	H3	3
* M4283	8	32	H3	3
* M4323	10	24	H3	3
* M4343	10	—	H3	3
* M4405	1/4	20	H5	3
* M4424	1/4	—	H4	3
* M4445	5/16	18	H5	3
* M4464	5/16	—	H4	3
* M4485	3/8	16	H5	3
* M4504	3/8	—	H4	3
* M4525	7/16	14	H5	3
* M4545	7/16	—	H5	3
* M4565	1/2	13	H5	3
* M4585	1/2	—	H5	3
* M4605	9/16	12	H5	3
* M4625	9/16	—	H5	3
* M4645	5/8	11	H5	3
* M4665	5/8	—	H5	3
* M4705	3/4	10	H5	3
* M4725	3/4	—	H5	3

► For tapping depth on DIN / ANSI Shank Taps, refer to DIN Table on page 199 & 200.

► Bright Finish Available : M5 series
► For tapping depth on ANSI Length Taps, refer to MCTI 302 on page 197.

◎ : Excellent ○ : Good

Low carbon steels/ Free machining carbon steels	Medium to high carbon steels/ Low alloyed steels	Steel castings & forgings / Heat-treatable alloy steels	Alloyed tool steels / Mold steels	Free machining stainless steels	Heat-and corrosionresistant stainless steels / Valve stainless steels	Stainless steel castings / Precipitation hardening stainless steels	Pure Aluminum/ Aluminum alloys			
○	◎	◎		◎	◎		○			
Aluminum alloy castings	Grey cast iron	Nodular cast iron / Chilled cast iron / Meehanite iron / Ductile iron	718 & 625 INCO / Waspaloy / Hastelloy / Invar / Monel / Incoloy	718 Inconel / A286	Titanium	Pure and alloyed copper	Free machining brass / Alloyed brass	Bronze	Zinc	Magnesium
						○	○		○	○

◎ : Excellent ○ : Good

Low carbon steels/ Free machining carbon steels	Medium to high carbon steels/ Low alloyed steels	Steel castings & forgings / Heat-treatable alloy steels	Alloyed tool steels / Mold steels	Free machining stainless steels	Heat-and corrosionresistant stainless steels / Valve stainless steels	Stainless steel castings / Precipitation hardening stainless steels	Pure Aluminum/ Aluminum alloys			
		○	◎		○	◎				
Aluminum alloy castings	Grey cast iron	Nodular cast iron / Chilled cast iron / Meehanite iron / Ductile iron	718 & 625 INCO / Waspaloy / Hastelloy / Invar / Monel / Incoloy	718 Inconel / A286	Titanium	Pure and alloyed copper	Free machining brass / Alloyed brass	Bronze	Zinc	Magnesium
			○	○	○			◎		

SPIRAL POINT TAPS

TQ808/TK808/TR808 SERIES

SPIRAL POINT TAPS

I3/I5/J6 SERIES

SPIRAL POINT TAPS PLUG STYLE Steels up to 45HRc

SPIRAL POINT TAPS PLUG STYLE for Titanium Alloys & Nickel Base Alloys up to 44HRc

Hole type 3.0xD

Hole type 3.0xD



USCTI

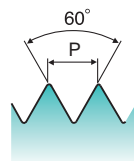

USCTI

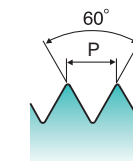

HR P-HSS M MF USCTI 302A H2-H5 60° 4P-5P Steam Oxide TiCN Hardslick ◇ Call for Availability

Ti Ni P-HSS UNC UNF USCTI 302A H2-H5 60° 4P-5P Steam Oxide TiCN Hardslick

	EDP No.			SIZE	Pitch	Limit	No. of Flute
	Steam Oxide	TiCN	Hardslick				
	TQ808203	TK808203	TR808203HAR	M3	0.5	D3	3
	TQ808253	TK808253	TR808253HAR	M4	0.5	D3	3
	TQ808244	TK808244	TR808244HAR	M4	0.7	D4	3
	TQ808293	TK808293	TR808293HAR	M5	0.5	D3	3
	TQ808284	TK808284	TR808284HAR	M5	0.8	D4	3
	TQ808333	TK808333	TR808333HAR	M6	0.5	D3	3
	TQ808324	TK808324	TR808324HAR	M6	0.75	D4	3
	TQ808315	TK808315	TR808315HAR	M6	1	D5	3
	TQ808375	TK808375	TR808375HAR	M8	1	D5	3
	TQ808365	TK808365	TR808365HAR	M8	1.25	D5	3
	TQ808445	TK808445	TR808445HAR	M10	1	D5	3
	TQ808435	TK808435	TR808435HAR	M10	1.25	D5	3
	TQ808426	TK808426	TR808426HAR	M10	1.5	D6	3
	TQ808535	TK808535	TR808535HAR	M12	1	D5	3
	TQ808526	TK808526	TR808526HAR	M12	1.25	D6	3
	TQ808516	TK808516	TR808516HAR	M12	1.5	D6	3
	TQ808506	TK808506	TR808506HAR	M12	1.75	D6	3
	TQ808556	TK808556	TR808556HAR	M14	1.5	D6	3
	TQ808547	TK808547	TR808547HAR	M14	2	D7	3
	TQ808616	TK808616	TR808616HAR	M16	1.5	D6	4
	TQ808607	TK808607	TR808607HAR	M16	2	D7	4
	TQ808676	TK808676	TR808676HAR	M18	1.5	D6	4
	TQ808657	TK808657	TR808657HAR	M18	2.5	D7	4
	TQ808726	TK808726	TR808726HAR	M20	1.5	D6	4
	TQ808707	TK808707	TR808707HAR	M20	2.5	D7	4
	TQ808766	TK808766	TR808766HAR	M22	1.5	D6	4
	TQ808747	TK808747	TR808747HAR	M22	2.5	D7	4
	TQ808806	TK808806	TR808806HAR	M24	1.5	D6	4
	TQ808788	TK808788	TR808788HAR	M24	3	D8	4

► For tapping depth on ANSI Length Taps, refer to MCTI 302 on page 198.

	EDP No.			SIZE	Thread Per Inch		Limit	No. of Flute
	Steam Oxide	TiCN	Hardslick		UNC	UNF		
	I3082	I5082	J6082	2	56	—	H2	2
	I3162	I5162	J6162	4	40	—	H2	2
	I3202	I5202	J6202	5	40	—	H2	3
	I3243	I5243	J6243	6	32	—	H3	3
	I3283	I5283	J6283	8	32	—	H3	3
	I3323	I5323	J6323	10	24	—	H3	3
	I3343	I5343	J6343	10	—	32	H3	3
	I3403	I5403	J6403	1/4	20	—	H3	3
	I3405	I5405	J6405	1/4	20	—	H5	3
	I3423	I5423	J6423	1/4	—	28	H3	3
	I3424	I5424	J6424	1/4	—	28	H4	3
	I3443	I5443	J6443	5/16	18	—	H3	3
	I3445	I5445	J6445	5/16	18	—	H5	3
	I3463	I5463	J6463	5/16	—	24	H3	3
	I3483	I5483	J6483	3/8	16	—	H3	3
	I3485	I5485	J6485	3/8	16	—	H5	3
	I3503	I5503	J6503	3/8	—	24	H3	3
	I3504	I5504	J6504	3/8	—	24	H4	3
	I3523	I5523	J6523	7/16	14	—	H3	3
	I3525	I5525	J6525	7/16	14	—	H5	3
	I3543	I5543	J6543	7/16	—	20	H3	3
	I3545	I5545	J6545	7/16	—	20	H5	3
	I3563	I5563	J6563	1/2	13	—	H3	3
	I3565	I5565	J6565	1/2	13	—	H5	3
	I3583	I5583	J6583	1/2	—	20	H3	3
	I3585	I5585	J6585	1/2	—	20	H5	3
	I3603	I5603	J6603	9/16	12	—	H3	3
	I3605	I5605	J6605	9/16	12	—	H5	3
	I3623	I5623	J6623	9/16	—	18	H3	3
	I3625	I5625	J6625	9/16	—	18	H5	3
	I3643	I5643	J6643	5/8	11	—	H3	3

► TiN Coated Available: M8 Series

► For tapping depth on ANSI Length Taps, refer to MCTI 302 on page 197.

► NEXT PAGE

◎ : Excellent ○ : Good

◎ : Excellent ○ : Good

Low carbon steels/ Free machining carbon steels	Medium to high carbon steels/ Low alloyed steels	Steel castings & forgings / Heat-treatable alloy steels	Alloyed tool steels / Mold steels	Free machining stainless steels	Heat-and corrosionresistant stainless steels / Valve stainless steels	Stainless steel castings / Precipitation hardening stainless steels	Pure Aluminum/ Aluminum alloys			
		○	◎		○	◎				
Aluminum alloy castings	Grey cast iron	Nodular cast iron / Chilled cast iron / Meehanite iron / Ductile iron	718 & 625 INCO / Waspaloy / Hastelloy / Invar / Monel / Incoloy	718 Inconel / A286	Titanium	Pure and alloyed copper	Free machining brass / Alloyed brass	Bronze	Zinc	Magnesium
			○	○	○			◎		

Low carbon steels/ Free machining carbon steels	Medium to high carbon steels/ Low alloyed steels	Steel castings & forgings / Heat-treatable alloy steels	Alloyed tool steels / Mold steels	Free machining stainless steels	Heat-and corrosionresistant stainless steels / Valve stainless steels	Stainless steel castings / Precipitation hardening stainless steels	Pure Aluminum/ Aluminum alloys			
Aluminum alloy castings	Grey cast iron	Nodular cast iron / Chilled cast iron / Meehanite iron / Ductile iron	718 & 625 INCO / Waspaloy / Hastelloy / Invar / Monel / Incoloy	718 Inconel / A286	Titanium	Pure and alloyed copper	Free machining brass / Alloyed brass	Bronze	Zinc	Magnesium
			◎	◎	◎					

YG SPIRAL POINT TAPS

13/15/J6 SERIES

SPIRAL POINT TAPS PLUG STYLE for Titanium Alloys & Nickel Base Alloys up to 44HRc

Hole type 3.0xD

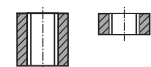

USCTI

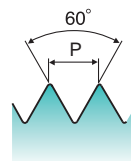

Ti Ni
P-HSS
UNC UNF
USCTI 302A
H2-H5
60°
4P-5P
Steam Oxide
TiCN
Hardslick

EDP No.	Thread Per Inch			Limit	No. of Flute		
	UNC	UNF	Limit				
I3645	I5645	J6645	5/8	11	—	H5	3
I3663	I5663	J6663	5/8	—	18	H3	3
I3665	I5665	J6665	5/8	—	18	H5	3
I3703	I5703	J6703	3/4	10	—	H3	3
I3705	I5705	J6705	3/4	10	—	H5	3
I3723	I5723	J6723	3/4	—	16	H3	3
I3725	I5725	J6725	3/4	—	16	H5	3

▶ TIN Coated Available : M8 Series
 ▶ For tapping depth on ANSI Length Taps, refer to MCTI 302 on page 197.

YG SPIRAL POINT TAPS

M2/M3 SERIES

SPIRAL POINT TAPS PLUG STYLE for Stainless Steels up to 28HRc

Hole type 3.0xD

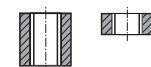

USCTI Long Shank

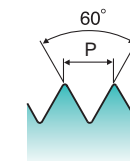

VA
P-HSS
UNC UNF
USCTI Long Shank
H2-H3
60°
4P-5P
Hardslick

EDP No.		SIZE	Thread Per Inch		Limit	No. of Flute	Maximum Tapping Depth
Hardslick Coated 4" OAL	Hardslick Coated 6" OAL		UNC	UNF			
M2162	—	4	40	—	H2	2	0.844
M2243	M3243	6	32	—	H3	2	1.031
M2283	M3283	8	32	—	H3	3	1.125
M2323	M3323	10	24	—	H3	3	1.312
M2343	M3343	10	—	32	H3	3	1.312
M2403	M3403	1/4	20	—	H3	3	1.500
—	M3423	1/4	—	28	H3	3	1.500
—	M3443	5/16	18	—	H3	3	1.688
—	M3463	5/16	—	24	H3	3	1.688
—	M3483	3/8	16	—	H3	3	1.875
—	M3503	3/8	—	24	H3	3	—
—	M3523	7/16	14	—	H3	3	—
—	M3543	7/16	—	20	H3	3	—
—	M3563	1/2	13	—	H3	3	—
—	M3583	1/2	—	20	H3	3	—
—	M3603	9/16	12	—	H3	3	—
—	M3623	9/16	—	18	H3	3	—
—	M3643	5/8	11	—	H3	3	—

▶ TIN Coated Available: 4" OAL M0 Series & 6" OAL M1 Series
 ▶ For tapping depth on DIN / ANSI Shank Taps, refer to DIN Table on page 199 & 200.

◎ : Excellent ○ : Good

Low carbon steels/ Free machining carbon steels	Medium to high carbon steels/ Low alloyed steels	Steel castings & forgings / Heat-treatable alloy steels	Alloyed tool steels / Mold steels	Free machining stainless steels	Heat-and corrosionresistant stainless steels / Valve stainless steels	Stainless steel castings / Precipitation hardening stainless steels	Pure Aluminum/ Aluminum alloys			
○	◎	◎	◎	◎	◎	◎	○			
Aluminum alloy castings	Grey cast iron	Nodular cast iron / Chilled cast iron / Meehanite iron / Ductile iron	718 & 625 INCO / Waspaloy / Hastelloy / Invar / Monel / Incoloy	718 Inconel / A286	Titanium	Pure and alloyed copper	Free machining brass / Alloyed brass	Bronze	Zinc	Magnesium
		◎	◎	◎						

◎ : Excellent ○ : Good

Low carbon steels/ Free machining carbon steels	Medium to high carbon steels/ Low alloyed steels	Steel castings & forgings / Heat-treatable alloy steels	Alloyed tool steels / Mold steels	Free machining stainless steels	Heat-and corrosionresistant stainless steels / Valve stainless steels	Stainless steel castings / Precipitation hardening stainless steels	Pure Aluminum/ Aluminum alloys			
○	◎	◎	◎	◎	◎	◎	○			
Aluminum alloy castings	Grey cast iron	Nodular cast iron / Chilled cast iron / Meehanite iron / Ductile iron	718 & 625 INCO / Waspaloy / Hastelloy / Invar / Monel / Incoloy	718 Inconel / A286	Titanium	Pure and alloyed copper	Free machining brass / Alloyed brass	Bronze	Zinc	Magnesium
						○	○		○	○

SPIRAL POINT TAPS

10/12/J2 SERIES

SPIRAL POINT TAPS

10/12/J2 SERIES

SPIRAL POINT TAPS PLUG STYLE for Stainless Steels up to 28HRc

SPIRAL POINT TAPS PLUG STYLE for Stainless Steels up to 28HRc

Hole type 3.0xD

Hole type 3.0xD

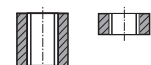
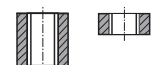

USCTI



USCTI

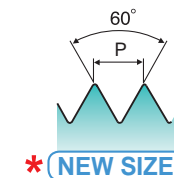
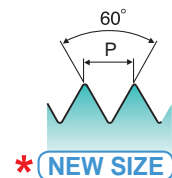

- VA
- HSSE-V3
- UNC UNF
- USCTI 302A
- H2-H7
- 60°
- 4P-5P
- Steam Oxide
- TiN
- Hardslick

- VA
- HSSE-V3
- UNC UNF
- USCTI 302A
- H2-H7
- 60°
- 4P-5P
- Steam Oxide
- TiN
- Hardslick

EDP No.	Thread Per Inch			Limit	No. of Flute		
	Steam Oxide	TiN	Hardslick				
I0082	I2082	J2082	2	56	H2	2	
* I0083	—	* J2083	2	56	H3	2	
* I0084	—	* J2084	2	56	H4	2	
* I0122	—	* J2122	3	48	H2	2	
I0162	I2162	J2162	4	40	H2	2	
* I0163	—	* J2163	4	40	H3	2	
* I0164	—	* J2164	4	40	H4	2	
* I0165	—	* J2165	4	40	H5	2	
* I0166	—	* J2166	4	40	H6	2	
* I0182	—	* J2182	4	—	48	H2	2
* I0184	—	* J2184	4	—	48	H4	2
I0202	I2202	J2202	5	40	H2	3	
I0243	I2243	J2243	6	32	H3	3	
* I0244	—	* J2244	6	32	H3	3	
* I0245	—	* J2245	6	32	H4	3	
* I0247	—	* J2247	6	32	H7	3	
* I0262	—	* J2262	6	—	40	H2	3
* I0263	—	* J2263	6	—	40	H3	3
* I0282	—	* J2282	8	32	H2	3	
I0283	I2283	J2283	8	32	H3	3	
* I0284	—	* J2284	8	32	H4	3	
* I0285	—	* J2286	8	32	H5	3	
* I0287	—	* J2287	8	32	H7	3	
* I0302	—	* J2302	8	—	36	H2	3
I0323	I2323	J2323	10	24	H3	3	
* I0324	—	* J2324	10	24	H4	3	
* I0325	—	* J2325	10	24	H5	3	
* I0342	—	* J2342	10	—	32	H2	3
I0343	I2343	J2343	10	—	32	H3	3
* I0344	—	* J2344	10	—	32	H4	3
* I0345	—	* J2345	10	—	32	H5	3
* I0346	—	* J2346	10	—	32	H6	3
* I0347	—	* J2347	10	—	32	H7	3

EDP No.	Thread Per Inch			Limit	No. of Flute		
	Steam Oxide	TiN	Hardslick				
* I0363	—	* J2363	12	24	H3	3	
* I0383	—	* J2383	12	—	28	H3	3
* I0402	—	* J2402	1/4	20	H2	3	
I0403	I2403	J2403	1/4	20	H3	3	
I0405	I2405	J2405	1/4	20	H5	3	
* I0407	—	* J2407	1/4	20	H7	3	
* I0422	—	* J2422	1/4	—	28	H2	3
I0423	I2423	J2423	1/4	—	28	H3	3
* I0424	—	* J2424	1/4	—	28	H4	3
* I0425	—	* J2425	1/4	—	28	H5	3
* I0426	—	* J2426	1/4	—	28	H6	3
* I0427	—	* J2427	1/4	—	28	H7	3
I0443	I2443	J2443	5/16	18	H3	3	
I0445	I2445	J2445	5/16	18	H5	3	
* I0447	—	* J2447	5/16	18	H7	3	
I0463	I2463	J2463	5/16	—	24	H3	3
* I0464	—	* J2464	5/16	—	24	H4	3
* I0465	—	* J2465	5/16	—	24	H5	3
* I0466	—	* J2466	5/16	—	24	H6	3
* I0467	—	* J2467	5/16	—	24	H7	3
I0483	I2483	J2483	3/8	16	H3	3	
I0485	I2485	J2485	3/8	16	H5	3	
* I0487	—	* J2487	3/8	16	H7	3	
I0503	I2503	J2503	3/8	—	24	H3	3
* I0504	—	* J2504	3/8	—	24	H4	3
* I0505	—	* J2505	3/8	—	24	H5	3
* I0507	—	* J2507	3/8	—	24	H7	3
I0523	I2523	J2523	7/16	14	H3	3	
I0525	I2525	J2525	7/16	14	H5	3	
I0543	I2543	J2543	7/16	—	20	H3	3
I0545	I2545	J2545	7/16	—	20	H5	3
I0563	I2563	J2563	1/2	13	H3	3	
I0565	I2565	J2565	1/2	13	H5	3	

► For tapping depth on ANSI Length Taps, refer to MCTI 302 on page 197.

► For tapping depth on ANSI Length Taps, refer to MCTI 302 on page 197.

► NEXT PAGE

► NEXT PAGE

◎ : Excellent ○ : Good

◎ : Excellent ○ : Good

Low carbon steels / Free machining carbon steels	Medium to high carbon steels / Low alloyed steels	Steel castings & forgings / Heat-treatable alloy steels	Alloyed tool steels / Mold steels	Free machining stainless steels	Heat and corrosion resistant stainless steels / Valve stainless steels	Stainless steel castings / Precipitation hardening stainless steels	Pure Aluminum / Aluminum alloys			
○	◎			◎			○			
Aluminum alloy castings	Grey cast iron	Nodular cast iron / Chilled cast iron / Meehanite iron / Ductile iron	718 & 625 INCO / Waspalloy / Hastelloy / Invar / Monel / Incoloy	718 Inconel / A286	Titanium	Pure and alloyed copper	Free machining brass / Alloyed brass	Bronze	Zinc	Magnesium
						○	○		○	○

Low carbon steels / Free machining carbon steels	Medium to high carbon steels / Low alloyed steels	Steel castings & forgings / Heat-treatable alloy steels	Alloyed tool steels / Mold steels	Free machining stainless steels	Heat and corrosion resistant stainless steels / Valve stainless steels	Stainless steel castings / Precipitation hardening stainless steels	Pure Aluminum / Aluminum alloys			
○	◎			◎			○			
Aluminum alloy castings	Grey cast iron	Nodular cast iron / Chilled cast iron / Meehanite iron / Ductile iron	718 & 625 INCO / Waspalloy / Hastelloy / Invar / Monel / Incoloy	718 Inconel / A286	Titanium	Pure and alloyed copper	Free machining brass / Alloyed brass	Bronze	Zinc	Magnesium
						○	○		○	○

Y/G SPIRAL POINT TAPS

10/12/J2 SERIES

Y/G SPIRAL POINT TAPS

09/IA SERIES

SPIRAL POINT TAPS PLUG STYLE for Stainless Steels up to 28HRc

METRIC SPIRAL POINT TAPS PLUG STYLE Stainless Steels up to 28HRc

Hole type 3.0xD

Hole type 3.0xD



USCTI

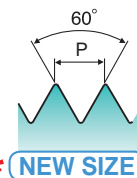

USCTI

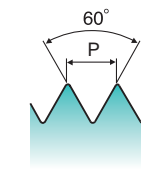

- VA
- HSSE-V3
- UNC UNF
- USCTI 302A
- H2-H7
- 60°
- 4P-5P
- Steam Oxide
- TiN
- Hardslick

- VA
- HSSE-V3
- M MF
- USCTI 302A
- D3-D7
- 60°
- 4P-5P
- Steam Oxide
- Hardslick

	EDP No.			SIZE	Thread Per Inch		Limit	No. of Flute
	Steam Oxide	TiN	Hardslick		UNC	UNF		
* I0567	—		* J2567	1/2	13	—	H7	3
I0583	I2583		J2583	1/2	—	20	H3	3
* I0585	—		* J2585	1/2	—	20	H5	3
I0603	I2603		J2603	9/16	12	—	H3	3
I0623	I2623		J2623	9/16	—	18	H3	3
I0643	I2643		J2643	5/8	11	—	H3	3
I0645	I2645		J2645	5/8	11	—	H5	3
* I0647	—		* J2647	5/8	11	—	H7	3
* I0663	—		* J2663	5/8	—	18	H3	3
I0665	I2665		J2665	5/8	—	18	H5	3
* I0667	—		* J2667	5/8	—	18	H7	3
I0703	I2703		J2703	3/4	10	—	H3	3
I0725	I2725		J2725	3/4	—	16	H5	3
I0744	I2744		J2744	7/8	9	—	H4	3
I0766	I2766		J2766	7/8	—	14	H6	3
I0784	I2784		J2784	1	8	—	H4	3
I0806	I2806		J2806	1	—	12	H6	3

► For tapping depth on ANSI Length Taps, refer to MCTI 302 on page 197.

	EDP No.		SIZE	Pitch	Limit	No. of Flute
	Steam Oxide	Hardslick				
O9203		IA203	M3	0.5	D3	3
O9224		IA224	M3.5	0.6	D4	3
O9244		IA244	M4	0.7	D4	3
O9284		IA284	M5	0.8	D4	3
O9315		IA315	M6	1.0	D5	3
O9345		IA345	M7	1.0	D5	3
O9365		IA365	M8	1.25	D5	3
O9375		IA375	M8	1.0	D5	3
O9426		IA426	M10	1.5	D6	3
O9435		IA435	M10	1.25	D5	3
O9506		IA506	M12	1.75	D6	3
O9525		IA525	M12	1.25	D5	3
O9547		IA547	M14	2.0	D7	3
O9556		IA556	M14	1.5	D6	3
O9607		IA607	M16	2.0	D7	3
O9616		IA616	M16	1.5	D6	3
O9657		IA657	M18	2.5	D7	3
O9676		IA676	M18	1.5	D6	3

► For tapping depth on ANSI Length Taps, refer to MCTI 302 on page 198.

◎ : Excellent ○ : Good

Low carbon steels/ Free machining carbon steels	Medium to high carbon steels/ Low alloyed steels	Steel castings & forgings / Heat-treatable alloy steels	Alloyed tool steels / Mold steels	Free machining stainless steels	Heat-and corrosionresistant stainless steels / Valve stainless steels	Stainless steel castings / Precipitation hardening stainless steels	Pure Aluminum/ Aluminum alloys				
○	◎			◎			○				
Aluminum alloy castings	Grey cast iron	Nodular cast iron / Chilled cast iron / Meehanite iron / Ductile iron	718 & 625 INCO / Waspaloy / Hastelloy / Invar / Monel / Incoloy	718 Inconel / A286	Titanium	Pure and alloyed copper	Free machining brass / Alloyed brass	Bronze	Zinc	Magnesium	
						○	○		○	○	

◎ : Excellent ○ : Good

Low carbon steels/ Free machining carbon steels	Medium to high carbon steels/ Low alloyed steels	Steel castings & forgings / Heat-treatable alloy steels	Alloyed tool steels / Mold steels	Free machining stainless steels	Heat-and corrosionresistant stainless steels / Valve stainless steels	Stainless steel castings / Precipitation hardening stainless steels	Pure Aluminum/ Aluminum alloys				
○	◎			◎			○				
Aluminum alloy castings	Grey cast iron	Nodular cast iron / Chilled cast iron / Meehanite iron / Ductile iron	718 & 625 INCO / Waspaloy / Hastelloy / Invar / Monel / Incoloy	718 Inconel / A286	Titanium	Pure and alloyed copper	Free machining brass / Alloyed brass	Bronze	Zinc	Magnesium	
						○	○		○	○	

YG SPIRAL POINT TAPS

K3/K5/K6 SERIES

YG SPIRAL POINT TAPS

J3/J8 SERIES

METRIC SPIRAL POINT TAPS PLUG STYLE
Stainless Steels up to 28HRc

SPIRAL POINT TAPS PLUG STYLE
Steels up to 38HRc

Hole type 3.0xD

Hole type 3.0xD



DIN-ANSI Shank

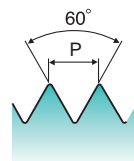

USCTI

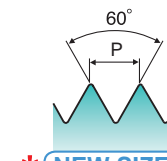

* NEW SIZE

- VA
- HSSE-V3
- M MF
- D3-D7
- 60°
- 4P-5P
- Steam Oxide
- TiCN
- Hardslick

- VG
- HSSE-V3
- UNC UNF
- USCTI 302A
- H2-H11
- 60°
- 4P-5P
- Steam Oxide
- Hardslick

	EDP No.			SIZE	Pitch	Limit	No. of Flute
	Steam Oxide	TiCN	Hardslick				
K3203	K5203	K6203	M3	0.5	D3	3	
K3224	K5224	K6224	M3.5	0.6	D4	3	
K3244	K5244	K6244	M4	0.7	D4	3	
K3284	K5284	K6284	M5	0.8	D4	3	
K3315	K5315	K6315	M6	1.0	D5	3	
K3345	K5345	K6345	M7	1.0	D5	3	
K3365	K5365	K6365	M8	1.25	D5	3	
K3375	K5375	K6375	M8	1.0	D5	3	
K3426	K5426	K6426	M10	1.5	D6	3	
K3435	K5435	K6435	M10	1.25	D5	3	
K3506	K5506	K6506	M12	1.75	D6	3	
K3525	K5525	K6525	M12	1.25	D5	3	
K3547	K5547	K6547	M14	2.0	D7	3	
K3556	K5556	K6556	M14	1.5	D6	3	
K3607	K5607	K6607	M16	2.0	D7	3	
K3616	K5616	K6616	M16	1.5	D6	3	
K3657	K5657	K6657	M18	2.5	D7	3	
K3676	K5676	K6676	M18	1.5	D6	3	

► For tapping depth on DIN / ANSI Shank Taps, refer to DIN Table on page 199 & 200.

EDP No.	SIZE	Thread Per Inch			Limit	No. of Flute
		UNC	UNF	8 Pitch		
J3082	J8082	2	56	—	H2	2
* J3122	J8122	3	48	—	H2	2
J3162	J8162	4	40	—	H2	2
* J3163	J8163	4	40	—	H3	2
* J3164	J8164	4	40	—	H4	2
* J3165	J8165	4	40	—	H5	2
* J3182	J8182	4	—	48	H2	2
J3202	J8202	5	40	—	H2	2
* J3242	J8242	6	32	—	H2	2
J3243	J8243	6	32	—	H3	2
* J3244	J8244	6	32	—	H4	2
* J3245	J8245	6	32	—	H5	2
* J3246	J8246	6	32	—	H6	2
* J3247	J8247	6	32	—	H7	2
* J324A	J824A	6	32	—	H11	2
* J3262	J8262	6	—	40	H2	2
* J3282	J8282	8	32	—	H2	3
J3283	J8283	8	32	—	H3	3
* J3284	J8284	8	32	—	H4	3
* J3285	J8285	8	32	—	H5	3
* J3286	J8286	8	32	—	H6	3
* J3287	J8287	8	32	—	H7	3
* J328A	J828A	8	32	—	H11	3
* J3302	J8302	8	—	36	H2	3
J3323	J8323	10	24	—	H3	3
* J3325	J8325	10	24	—	H5	3
* J332A	J832A	10	24	—	H11	3
* J3342	J8342	10	—	32	H2	3
J3343	J8343	10	—	32	H3	3
* J3344	J8344	10	—	32	H4	3
* J3345	J8345	10	—	32	H5	3
* J3346	J8346	10	—	32	H6	3

► Bright Finish Available: J4 Series

► For tapping depth on ANSI Length Taps, refer to MCTI 302 on page 197.

► NEXT PAGE

◎ : Excellent ○ : Good

◎ : Excellent ○ : Good

Low carbon steels/ Free machining carbon steels	Medium to high carbon steels/ Low alloyed steels	Steel castings & forgings / Heat-treatable alloy steels	Alloyed tool steels / Mold steels	Free machining stainless steels	Heat-and corrosionresistant stainless steels / Valve stainless steels	Stainless steel castings / Precipitation hardening stainless steels	Pure Aluminum/ Aluminum alloys				
○	◎			◎			○				
Aluminum alloy castings	Grey cast iron	Nodular cast iron / Chilled cast iron / Meehanite iron / Ductile iron	718 & 625 INCO / Waspaloy / Hastelloy / Invar / Monel / Incoloy	718 Inconel / A286	Titanium	Pure and alloyed copper	Free machining brass / Alloyed brass	Bronze	Zinc	Magnesium	
						○	○		○	○	

Low carbon steels/ Free machining carbon steels	Medium to high carbon steels/ Low alloyed steels	Steel castings & forgings / Heat-treatable alloy steels	Alloyed tool steels / Mold steels	Free machining stainless steels	Heat-and corrosionresistant stainless steels / Valve stainless steels	Stainless steel castings / Precipitation hardening stainless steels	Pure Aluminum/ Aluminum alloys				
	◎	◎		○	○						
Aluminum alloy castings	Grey cast iron	Nodular cast iron / Chilled cast iron / Meehanite iron / Ductile iron	718 & 625 INCO / Waspaloy / Hastelloy / Invar / Monel / Incoloy	718 Inconel / A286	Titanium	Pure and alloyed copper	Free machining brass / Alloyed brass	Bronze	Zinc	Magnesium	
						○					

SPIRAL POINT TAPS

J3/J8 SERIES

SPIRAL POINT TAPS

J3/J8 SERIES

SPIRAL POINT TAPS PLUG STYLE Steels up to 38HRc

SPIRAL POINT TAPS PLUG STYLE Steels up to 38HRc

A variety of H Limit

A variety of H Limit

Hole type 3.0xD

Hole type 3.0xD



USCTI

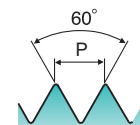

* NEW SIZE



USCTI

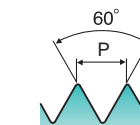

* NEW SIZE

VG HSSE-V3 UNC UNF USCTI 302A H2-H11 4P-5P Steam Oxide Hardslick

VG HSSE-V3 UNC UNF USCTI 302A H2-H11 4P-5P Steam Oxide Hardslick

STRAIGHT FLUTE TAPS

FORMING TAPS

SCREW THREAD INSERT TAPS

PIPE TAPS

TECHNICAL DATA

EDP No.	Thread Per Inch		Limit	No. of Flute		
	UNC	UNF				
* J3347	J8347	10	—	32	H7	3
* J334A	J834A	10	—	32	H11	3
* J3363	J8363	12	24	—	H3	3
* J3383	J8383	12	—	28	H3	3
* J3402	J8402	1/4	20	—	H2	3
J3403	J8403	1/4	20	—	H3	3
J3405	J8405	1/4	20	—	H5	3
* J3407	J8407	1/4	20	—	H7	3
* J340A	J840A	1/4	20	—	H11	3
* J3422	J8422	1/4	—	28	H2	3
J3423	J8423	1/4	—	28	H3	3
* J3424	J8424	1/4	—	28	H4	3
J3425	J8425	1/4	—	28	H5	3
* J3426	J8426	1/4	—	28	H6	3
* J3427	J8427	1/4	—	28	H7	3
* J342A	J842A	1/4	—	28	H11	3
J3443	J8443	5/16	18	—	H3	3
J3445	J8445	5/16	18	—	H5	3
* J3447	J8447	5/16	18	—	H7	3
* J344A	J844A	5/16	18	—	H11	3
* J3462	J8462	5/16	—	24	H2	3
J3463	J8463	5/16	—	24	H3	3
* J3464	J8464	5/16	—	24	H4	3
J3465	J8465	5/16	—	24	H5	3
* J3466	J8466	5/16	—	24	H6	3
* J3467	J8467	5/16	—	24	H7	3
* J346A	J846A	5/16	—	24	H11	3
J3483	J8483	3/8	16	—	H3	3
J3485	J8485	3/8	16	—	H5	3
* J3487	J8487	3/8	16	—	H7	3
* J348A	J848A	3/8	16	—	H11	3
* J3502	J8502	3/8	—	24	H2	3

► Bright Finish Available: J4 Series
► For tapping depth on ANSI Length Taps, refer to MCTI 302 on page 197. ► NEXT PAGE

◎ : Excellent ○ : Good

Low carbon steels / Free machining carbon steels	Medium to high carbon steels / Low alloyed steels	Steel castings & forgings / Heat-treatable alloy steels	Alloyed tool steels / Mold steels	Free machining stainless steels	Heat-and corrosionresistant stainless steels / Valve stainless steels	Stainless steel castings / Precipitation hardening stainless steels	Pure Aluminum / Aluminum alloys			
◎	◎	◎	◎	○	○	◎	◎			
Aluminum alloy castings	Grey cast iron	Nodular cast iron / Chilled cast iron / Meehanite iron / Ductile iron	718 & 625 INCO / Waspaloy / Hastelloy / Invar / Monel / Incoloy	718 Inconel / A286	Titanium	Pure and alloyed copper	Free machining brass / Alloyed brass	Bronze	Zinc	Magnesium
			○							

STRAIGHT FLUTE TAPS

FORMING TAPS

SCREW THREAD INSERT TAPS

PIPE TAPS

TECHNICAL DATA

EDP No.	Thread Per Inch		Limit	No. of Flute		
	UNC	UNF				
J3503	J8503	3/8	—	24	H3	3
* J3504	J8504	3/8	—	24	H4	3
J3505	J8505	3/8	—	24	H5	3
* J3506	J8506	3/8	—	24	H6	3
* J3507	J8507	3/8	—	24	H7	3
* J350A	J850A	3/8	—	24	H11	3
J3523	J8523	7/16	14	—	H3	3
J3525	J8525	7/16	14	—	H5	3
* J3527	J8527	7/16	14	—	H7	3
* J352A	J852A	7/16	14	—	H11	3
J3543	J8543	7/16	—	20	H3	3
J3545	J8545	7/16	—	20	H5	3
* J3547	J8547	7/16	—	20	H7	3
* J354A	J854A	7/16	—	20	H11	3
J3563	J8563	1/2	13	—	H3	3
J3565	J8565	1/2	13	—	H5	3
* J3567	J8567	1/2	13	—	H7	3
* J356A	J856A	1/2	13	—	H11	3
* J3582	J8582	1/2	—	20	H2	3
J3583	J8583	1/2	—	20	H3	3
J3585	J8585	1/2	—	20	H5	3
* J3587	J8587	1/2	—	20	H7	3
* J358A	J858A	1/2	—	20	H11	3
J3605	J8605	9/16	12	—	H5	3
J3625	J8625	9/16	—	18	H5	3
J3643	J8643	5/8	11	—	H3	3
J3645	J8645	5/8	11	—	H5	3
J3663	J8663	5/8	—	18	H3	3
J3665	J8665	5/8	—	18	H5	3
* J3667	J8667	5/8	—	18	H7	3
J3703	J8703	3/4	10	—	H3	3
J3705	J8705	3/4	10	—	H5	3

► Bright Finish Available: J4 Series
► For tapping depth on ANSI Length Taps, refer to MCTI 302 on page 197. ► NEXT PAGE

◎ : Excellent ○ : Good

Low carbon steels / Free machining carbon steels	Medium to high carbon steels / Low alloyed steels	Steel castings & forgings / Heat-treatable alloy steels	Alloyed tool steels / Mold steels	Free machining stainless steels	Heat-and corrosionresistant stainless steels / Valve stainless steels	Stainless steel castings / Precipitation hardening stainless steels	Pure Aluminum / Aluminum alloys			
◎	◎	◎	◎	○	○	◎	◎			
Aluminum alloy castings	Grey cast iron	Nodular cast iron / Chilled cast iron / Meehanite iron / Ductile iron	718 & 625 INCO / Waspaloy / Hastelloy / Invar / Monel / Incoloy	718 Inconel / A286	Titanium	Pure and alloyed copper	Free machining brass / Alloyed brass	Bronze	Zinc	Magnesium
			○							

YG SPIRAL POINT TAPS

J3/J8 SERIES

SPIRAL POINT TAPS PLUG STYLE
Steels up to 38HRc

A variety of H Limit

Hole type 3.0xD



USCTI

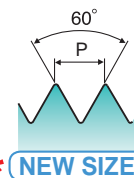

* NEW SIZE

VG
HSSE-V3
UNC UNF
USCTI 302A
H2-H11
4P~5P
Steam Oxide
Hardslick

EDP No.	Thread Per Inch		Limit	No. of Flute
	Steam Oxide	Hardslick		
J3723	J8723	3/4	—	16
J3725	J8725	3/4	—	16
* J3745	J8745	7/8	9	—
* J3764	J8764	7/8	—	14
J3784	J8784	1	8	—
J3804	J8804	1	—	12
* J3826	J8826	1-1/8	7	—
* J3845	J8845	1-1/8	—	12
* J3836	J8836	1-1/8	—	8
* J3866	J8866	1-1/4	7	—
* J3885	J8885	1-1/4	—	12
* J3876	J8876	1-1/4	—	8
* J3906	J8906	1-3/8	6	—
* J3925	J8925	1-3/8	—	12
* J3916	J8916	1-3/8	—	8
* J3946	J8946	1-1/2	6	—
* J3965	J8965	1-1/2	—	12
* J3956	J8956	1-1/2	—	8

► Bright Finish Available: J4 Series
► For tapping depth on ANSI Length Taps, refer to MCTI 302 on page 197.

◎ : Excellent ○ : Good

Low carbon steels/ Free machining carbon steels	Medium to high carbon steels/ Low alloyed steels	Steel castings & forgings / Heat-treatable alloy steels	Alloyed tool steels / Mold steels	Free machining stainless steels	Heat-and corrosionresistant stainless steels / Valve stainless steels	Stainless steel castings / Precipitation hardening stainless steels	Pure Aluminum/ Aluminum alloys			
◎	◎	◎	◎	○	○	◎	◎			
Aluminum alloy castings	Grey cast iron	Nodular cast iron / Chilled cast iron / Meehanite iron / Ductile iron	718 & 625 INCO / Waspaloy / Hastelloy / Invar / Monel / Incoloy	718 Inconel / A286	Titanium	Pure and alloyed copper	Free machining brass / Alloyed brass	Bronze	Zinc	Magnesium
◎	◎	◎	◎	◎	◎	◎	◎	◎	◎	◎

YG SPIRAL POINT TAPS

IB/IC SERIES

METRIC SPIRAL POINT TAPS PLUG STYLE
Steels up to 35HRc

A variety of D Limit

Hole type 3.0xD



USCTI

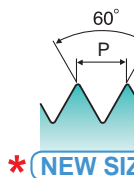

* NEW SIZE

VG
HSSE-V3
M MF
USCTI 302A
D3~D11
4P~5P
Steam Oxide
Hardslick

EDP No.		SIZE	Pitch	Limit	No. of Flute
Steam Oxide	Hardslick				
IB203	IC203	M3	0.5	D3	3
* IB20A	IC20A	M3	0.5	D11	3
IB224	IC224	M3.5	0.6	D4	3
* IB22A	IC22A	M3.5	0.6	D11	3
IB244	IC244	M4	0.7	D4	3
* IB24A	IC24A	M4	0.7	D11	3
IB284	IC284	M5	0.8	D4	3
* IB28A	IC28A	M5	0.8	D11	3
IB315	IC315	M6	1.0	D5	3
* IB31A	IC31A	M6	1.0	D11	3
IB345	IC345	M7	1.0	D5	3
* IB34A	IC34A	M7	1.0	D11	3
IB375	IC375	M8	1.0	D5	3
* IB37A	IC37A	M8	1.0	D11	3
IB365	IC365	M8	1.25	D5	3
* IB36A	IC36A	M8	1.25	D11	3
* IB445	IC445	M10	1.0	D5	3
* IB44A	IC44A	M10	1.0	D11	3
IB435	IC435	M10	1.25	D5	3
* IB43A	IC43A	M10	1.25	D11	3
IB426	IC426	M10	1.5	D6	3
* IB42A	IC42A	M10	1.5	D11	3
IB525	IC525	M12	1.25	D5	3
* IB52A	IC52A	M12	1.25	D11	3
* IB516	IC516	M12	1.5	D6	3
* IB51A	IC51A	M12	1.5	D11	3
IB506	IC506	M12	1.75	D6	3
* IB50A	IC50A	M12	1.75	D11	3
IB556	IC556	M14	1.5	D6	3
IB547	IC547	M14	2.0	D7	3
IB616	IC616	M16	1.5	D6	3
IB607	IC607	M16	2.0	D7	3

► For tapping depth on ANSI Length Taps, refer to MCTI 302 on page 198.

► NEXT PAGE

◎ : Excellent ○ : Good

Low carbon steels/ Free machining carbon steels	Medium to high carbon steels/ Low alloyed steels	Steel castings & forgings / Heat-treatable alloy steels	Alloyed tool steels / Mold steels	Free machining stainless steels	Heat-and corrosionresistant stainless steels / Valve stainless steels	Stainless steel castings / Precipitation hardening stainless steels	Pure Aluminum/ Aluminum alloys			
◎	◎	◎	◎	○	○	◎	◎			
Aluminum alloy castings	Grey cast iron	Nodular cast iron / Chilled cast iron / Meehanite iron / Ductile iron	718 & 625 INCO / Waspaloy / Hastelloy / Invar / Monel / Incoloy	718 Inconel / A286	Titanium	Pure and alloyed copper	Free machining brass / Alloyed brass	Bronze	Zinc	Magnesium
◎	◎	◎	◎	◎	◎	◎	◎	◎	◎	◎

YG SPIRAL POINT TAPS

IB/IC SERIES

METRIC SPIRAL POINT TAPS PLUG STYLE
Steels up to 35HRc

A variety of D Limit

Hole type 3.0xD



USCTI



- VG
- HSSE-V3
- M MF
- USCTI 302A
- D3~D11
- 60°
- 4P~5P
- Steam Oxide
- Hardslick

EDP No.		SIZE	Pitch	Limit	No. of Flute
Steam Oxide	Hardslick				
IB676	IC676	M18	1.5	D6	4
IB657	IC657	M18	2.5	D7	4
* IB726	IC726	M20	1.5	D6	3
* IB708	IC708	M20	2.5	D8	3
* IB766	IC766	M22	1.5	D6	3
* IB748	IC748	M22	2.5	D8	3
* IB806	IC806	M24	1.5	D6	4
* IB788	IC788	M24	3.0	D8	4
* IB886	IC886	M27	1.5	D6	4
* IB868	IC868	M27	3.0	D8	4
* IB976	IC976	M30	1.5	D6	4
* IB949	IC949	M30	3.5	D9	4

► For tapping depth on ANSI Length Taps, refer to MCTI 302 on page 198.

◎ : Excellent ○ : Good

Low carbon steels/ Free machining carbon steels	Medium to high carbon steels/ Low alloyed steels	Steel castings & forgings / Heat-treatable alloy steels	Alloyed tool steels / Mold steels	Free machining stainless steels	Heat-and corrosionresistant stainless steels / Valve stainless steels	Stainless steel castings / Precipitation hardening stainless steels	Pure Aluminum/ Aluminum alloys			
	◎	◎		○	○					
Aluminum alloy castings	Grey cast iron	Nodular cast iron / Chilled cast iron / Meehanite iron / Ductile iron	718 & 625 INCO / Waspaloy / Hastelloy / Invar / Monel / Incoloy	718 Inconel / A286	Titanium	Pure and alloyed copper	Free machining brass / Alloyed brass	Bronze	Zinc	Magnesium
			○							

YG SPIRAL POINT TAPS

J9/K7/K2 SERIES

METRIC SPIRAL POINT TAPS PLUG STYLE
Steels up to 35HRc

Hole type 3.0xD



DIN-ANSI Shank

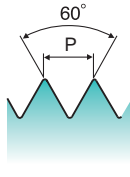

- VG
- HSSE-V3
- M MF
- D3~D7
- 60°
- 4P~5P
- Steam Oxide
- TiCN
- Hardslick

EDP No.			SIZE	Pitch	Limit	No. of Flute
Steam Oxide	TiCN	Hardslick				
J9203	K7203	K2203	M3	0.5	D3	3
J9224	K7224	K2224	M3.5	0.6	D4	3
J9244	K7244	K2244	M4	0.7	D4	3
J9284	K7284	K2284	M5	0.8	D4	3
J9315	K7315	K2315	M6	1.0	D5	3
J9345	K7345	K2345	M7	1.0	D5	3
J9365	K7365	K2365	M8	1.25	D5	3
J9375	K7375	K2375	M8	1.0	D5	3
J9426	K7426	K2426	M10	1.5	D6	3
J9435	K7435	K2435	M10	1.25	D5	3
J9506	K7506	K2506	M12	1.75	D6	3
J9525	K7525	K2525	M12	1.25	D5	3
J9547	K7547	K2547	M14	2.0	D7	3
J9556	K7556	K2556	M14	1.5	D6	3
J9607	K7607	K2607	M16	2.0	D7	3
J9616	K7616	K2616	M16	1.5	D6	3
J9657	K7657	K2657	M18	2.5	D7	4
J9676	K7676	K2676	M18	1.5	D6	4

► For tapping depth on DIN / ANSI Shank Taps, refer to DIN Table on page 199 & 200.

◎ : Excellent ○ : Good

Low carbon steels/ Free machining carbon steels	Medium to high carbon steels/ Low alloyed steels	Steel castings & forgings / Heat-treatable alloy steels	Alloyed tool steels / Mold steels	Free machining stainless steels	Heat-and corrosionresistant stainless steels / Valve stainless steels	Stainless steel castings / Precipitation hardening stainless steels	Pure Aluminum/ Aluminum alloys			
	◎	◎		○	○					
Aluminum alloy castings	Grey cast iron	Nodular cast iron / Chilled cast iron / Meehanite iron / Ductile iron	718 & 625 INCO / Waspaloy / Hastelloy / Invar / Monel / Incoloy	718 Inconel / A286	Titanium	Pure and alloyed copper	Free machining brass / Alloyed brass	Bronze	Zinc	Magnesium
			○							

YG SPIRAL POINT TAPS

T2496 SERIES

YG SPIRAL POINT TAPS

T2K01 SERIES

SPIRAL POINT TAPS PLUG STYLE
for Aluminum Alloy or Die Cast Aluminum

METRIC SPIRAL POINT TAPS PLUG STYLE
for Aluminum Alloy or Die Cast Aluminum

Hole type 3.0xD

Hole type 3.0xD



USCTI

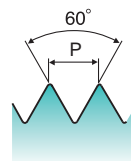

USCTI

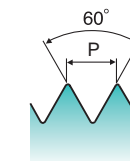

AI HSSE-V3 UNC UNF USCTI 302A H2-H5 60° 4P-5P Bright ◇ Call for Availability

AI HSSE-V3 M MF USCTI 302A D3-D6 60° 4P-5P Bright ◇ Call for Availability

EDP No.	SIZE	Thread Per Inch		Limit	No. of Flute
		UNC	UNF		
◇ T2496162	4	40	—	H2	2
◇ T2496163	4	40	—	H3	2
◇ T2496242	6	32	—	H2	2
◇ T2496243	6	32	—	H3	2
◇ T2496282	8	32	—	H2	2
◇ T2496283	8	32	—	H3	2
◇ T2496323	10	24	—	H3	2
◇ T2496342	10	—	32	H2	2
◇ T2496343	10	—	32	H3	2
◇ T2496345	10	—	32	H5	2
◇ T2496403	1/4	20	—	H3	2
◇ T2496405	1/4	20	—	H5	2
◇ T2496423	1/4	—	28	H3	2
◇ T2496443	5/16	18	—	H3	2
◇ T2496445	5/16	18	—	H5	2
◇ T2496463	5/16	—	24	H3	2
◇ T2496465	5/16	—	24	H5	2
◇ T2496483	3/8	16	—	H3	3
◇ T2496485	3/8	16	—	H5	3
◇ T2496503	3/8	—	24	H3	3
◇ T2496505	3/8	—	24	H5	3
◇ T2496563	1/2	13	-	H3	3
◇ T2496565	1/2	13	-	H5	3
◇ T2496583	1/2	-	20	H3	3
◇ T2496643	5/8	11	—	H3	3
◇ T2496663	5/8	—	18	H3	3
◇ T2496703	3/4	10	—	H3	3
◇ T2496723	3/4	—	16	H3	3
◇ T2496744	7/8	9	—	H4	3
◇ T2496764	7/8	—	14	H4	3
◇ T2496784	1	1	—	H4	3

EDP No.	SIZE	Pitch	Thread Limit	No. of Flute
◇ T2K01203	M3	0.5	D3	2
◇ T2K01244	M4	0.7	D4	2
◇ T2K01284	M5	0.8	D4	2
◇ T2K01315	M6	1.0	D5	2
◇ T2K01365	M8	1.25	D5	2
◇ T2K01435	M10	1.25	D5	3
◇ T2K01426	M10	1.5	D6	3
◇ T2K01525	M12	1.25	D5	3
◇ T2K01515	M12	1.5	D5	3
◇ T2K01506	M12	1.75	D6	3

► For tapping depth on ANSI Length Taps, refer to MCTI 302 on page 197.

► For tapping depth on ANSI Length Taps, refer to MCTI 302 on page 198.

◎ : Excellent ○ : Good

◎ : Excellent ○ : Good

Low carbon steels / Free machining carbon steels	Medium to high carbon steels / Low alloyed steels	Steel castings & forgings / Heat-treatable alloy steels	Alloyed tool steels / Mold steels	Free machining stainless steels	Heat-and corrosionresistant stainless steels / Valve stainless steels	Stainless steel castings / Precipitation hardening stainless steels	Pure Aluminum / Aluminum alloys				
							◎				
Aluminum alloy castings	Grey cast iron	Nodular cast iron / Meehanite iron / Ductile iron	718 & 625 INCO / Waspaloy / Hastelloy / Invar / Monel / Incoloy	718 Inconel / A286	Titanium	Pure and alloyed copper	Free machining brass / Alloyed brass	Bronze	Zinc	Magnesium	
◎											

Low carbon steels / Free machining carbon steels	Medium to high carbon steels / Low alloyed steels	Steel castings & forgings / Heat-treatable alloy steels	Alloyed tool steels / Mold steels	Free machining stainless steels	Heat-and corrosionresistant stainless steels / Valve stainless steels	Stainless steel castings / Precipitation hardening stainless steels	Pure Aluminum / Aluminum alloys				
							◎				
Aluminum alloy castings	Grey cast iron	Nodular cast iron / Meehanite iron / Ductile iron	718 & 625 INCO / Waspaloy / Hastelloy / Invar / Monel / Incoloy	718 Inconel / A286	Titanium	Pure and alloyed copper	Free machining brass / Alloyed brass	Bronze	Zinc	Magnesium	
◎											

YG SPIRAL POINT TAPS

I9/J0/J1/J7 SERIES

STANDARD TAPS : SPIRAL POINT PLUG STYLE for General Purpose

Hole type 3.0xD



USCTI

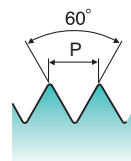

- GS
- HSSE-V3
- UNC UNF
- USCTI
- H2-H6
- 60°
- 4P-5P
- Steam Oxide
- Bright
- TiN
- Hardslick

EDP No.	Thread Per Inch				SIZE	Thread Per Inch		Limit	No. of Flute
	Steam Oxide	Bright	TiN	Hardslick		UNC	UNF		
I9082	J0082	J1082	J7082	2	56	—	H2	2	
I9162	J0162	J1162	J7162	4	40	—	H2	2	
I9202	J0202	J1202	J7202	5	40	—	H2	2	
I9243	J0243	J1243	J7243	6	32	—	H3	2	
I9283	J0283	J1283	J7283	8	32	—	H3	2	
I9323	J0323	J1323	J7323	10	24	—	H3	2	
I9343	J0343	J1343	J7343	10	—	32	H3	2	
I9403	J0403	J1403	J7403	1/4	20	—	H3	2	
I9405	J0405	J1405	J7405	1/4	20	—	H5	2	
I9423	J0423	J1423	J7423	1/4	—	28	H3	2	
I9443	J0443	J1443	J7443	5/16	18	—	H3	2	
I9445	J0445	J1445	J7445	5/16	18	—	H5	2	
I9463	J0463	J1463	J7463	5/16	—	24	H3	2	
I9483	J0483	J1483	J7483	3/8	16	—	H3	3	
I9485	J0485	J1485	J7485	3/8	16	—	H5	3	
I9503	J0503	J1503	J7503	3/8	—	24	H3	3	
I9523	J0523	J1523	J7523	7/16	14	—	H3	3	
I9525	J0525	J1525	J7525	7/16	14	—	H5	3	
I9543	J0543	J1543	J7543	7/16	—	20	H3	3	
I9545	J0545	J1545	J7545	7/16	—	20	H5	3	
I9563	J0563	J1563	J7563	1/2	13	—	H3	3	
I9565	J0565	J1565	J7565	1/2	13	—	H5	3	
I9583	J0583	J1583	J7583	1/2	—	20	H3	3	
I9585	J0585	J1585	J7585	1/2	—	20	H5	3	
I9603	J0603	J1603	J7603	9/16	12	—	H3	3	
I9625	J0625	J1625	J7625	9/16	—	18	H5	3	
I9643	J0643	J1643	J7643	5/8	11	—	H3	3	
I9645	J0645	J1645	J7645	5/8	11	—	H5	3	
I9665	J0665	J1665	J7665	5/8	—	18	H5	3	
I9703	J0703	J1703	J7703	3/4	10	—	H3	3	
I9705	J0705	J1705	J7705	3/4	10	—	H5	3	
I9725	J0725	J1725	J7725	3/4	—	16	H5	3	
I9744	J0744	J1744	J7744	7/8	9	—	H4	3	
I9766	J0766	J1766	J7766	7/8	—	14	H6	3	
I9784	J0784	J1784	J7784	1	8	—	H4	3	

► For tapping depth on ANSI Length Taps, refer to MCTI 302 on page 201. © : Excellent ○ : Good

Low carbon steels / Free machining carbon steels	Medium to high carbon steels / Low alloyed steels	Steel castings & forgings / Heat-treatable alloy steels	Alloyed tool steels / Mold steels	Free machining stainless steels	Heat-and corrosionresistant stainless steels / Valve stainless steels	Stainless steel castings / Precipitation hardening stainless steels	Pure Aluminum / Aluminum alloys			
○	○	○	○	○	○	○	○			
Aluminum alloy castings	Grey cast iron	Nodular cast iron / Chilled cast iron / Meehanite iron / Ductile iron	718 & 625 INCO / Waspaloy / Hastelloy / Invar / Monel / Incoloy	718 Inconel / A286	Titanium	Pure and alloyed copper	Free machining brass / Alloyed brass	Bronze	Zinc	Magnesium
○	○	○	○	○	○	○	○	○	○	○

YG SPIRAL POINT TAPS

K9/L0/L1 SERIES

SPIRAL POINT TAPS PLUG STYLE for General Purpose

Hole type 3.0xD



USCTI

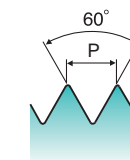

- GS
- HSS-V
- UNC UNF
- USCTI 302A
- H2-H6
- 60°
- 4P-5P
- Bright
- TiN
- Hardslick

EDP No.			SIZE	Thread Per Inch		Limit	No. of Flute
Bright	TiN	Hardslick		UNC	UNF		
K9082	L0082	L1082	2	56	—	H2	2
K9162	L0162	L1162	4	40	—	H2	2
K9202	L0202	L1202	5	40	—	H2	2
K9243	L0243	L1243	6	32	—	H3	2
K9283	L0283	L1283	8	32	—	H3	2
K9323	L0323	L1323	10	24	—	H3	2
K9343	L0343	L1343	10	—	32	H3	2
K9403	L0403	L1403	1/4	20	—	H3	2
K9405	L0405	L1405	1/4	20	—	H5	2
K9423	L0423	L1423	1/4	—	28	H3	3
K9443	L0443	L1443	5/16	18	—	H3	2
K9445	L0445	L1445	5/16	18	—	H5	3
K9463	L0463	L1463	5/16	—	24	H3	3
K9483	L0483	L1483	3/8	16	—	H3	3
K9485	L0485	L1485	3/8	16	—	H5	3
K9503	L0503	L1503	3/8	—	24	H3	3
K9523	L0523	L1523	7/16	14	—	H3	3
K9525	L0525	L1525	7/16	14	—	H5	3
K9543	L0543	L1543	7/16	—	20	H3	3
K9545	L0545	L1545	7/16	—	20	H5	3
K9563	L0563	L1563	1/2	13	—	H3	3
K9565	L0565	L1565	1/2	13	—	H5	3
K9583	L0583	L1583	1/2	—	20	H3	3
K9585	L0585	L1585	1/2	—	20	H5	3
K9603	L0603	L1603	9/16	12	—	H3	3
K9623	L0623	L1623	9/16	—	18	H3	3
K9625	L0625	L1625	9/16	—	18	H5	3
K9643	L0643	L1643	5/8	11	—	H3	3
K9645	L0645	L1645	5/8	11	—	H5	3
K9663	L0663	L1663	5/8	—	18	H3	3
K9665	L0665	L1665	5/8	—	18	H5	3
K9703	L0703	L1703	3/4	10	—	H3	3
K9705	L0705	L1705	3/4	10	—	H5	3
K9723	L0723	L1723	3/4	—	16	H3	3
K9725	L0725	L1725	3/4	—	16	H5	3
K9746	L0746	L1746	7/8	9	—	H6	3
K9764	L0764	L1764	7/8	—	14	H4	3
K9766	L0766	L1766	7/8	—	14	H6	3
K9786	L0786	L1786	1	8	—	H6	3
K9806	L0806	L1806	1	—	12	H6	3

► For tapping depth on ANSI Length Taps, refer to MCTI 302 on page 201. © : Excellent ○ : Good

Low carbon steels / Free machining carbon steels	Medium to high carbon steels / Low alloyed steels	Steel castings & forgings / Heat-treatable alloy steels	Alloyed tool steels / Mold steels	Free machining stainless steels	Heat-and corrosionresistant stainless steels / Valve stainless steels	Stainless steel castings / Precipitation hardening stainless steels	Pure Aluminum / Aluminum alloys			
○	○	○	○	○	○	○	○			
Aluminum alloy castings	Grey cast iron	Nodular cast iron / Chilled cast iron / Meehanite iron / Ductile iron	718 & 625 INCO / Waspaloy / Hastelloy / Invar / Monel / Incoloy	718 Inconel / A286	Titanium	Pure and alloyed copper	Free machining brass / Alloyed brass	Bronze	Zinc	Magnesium
○	○	○	○	○	○	○	○	○	○	○

Y/G SPIRAL POINT TAPS

L7/L8/L9 SERIES

Y/G SPIRAL POINT TAPS

L3/L4/L5 SERIES

METRIC SPIRAL POINT TAPS PLUG STYLE for General Purpose

SPIRAL POINT TAPS PLUG STYLE for General Purpose

Hole type 3.0xD

Hole type 3.0xD



USCTI

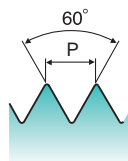

DIN-ANSI Shank

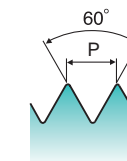

GS HSS-V M MF USCTI 302A D3~D6 60° 4P~5P Bright TiCN Hardslick

GS HSS-V UNC UNF H2~H6 60° 4P~5P Bright TiN Hardslick

	EDP No.			SIZE	Pitch	Limit	No. of Flute
	Bright	TiCN	Hardslick				
FORMING TAPS	L7203	L8203	L9203	M3	0.5	D3	2
	L7224	L8224	L9224	M3.5	0.6	D4	2
	L7244	L8244	L9244	M4	0.7	D4	2
SCREW THREAD INSERT TAPS	L7284	L8284	L9284	M5	0.8	D4	2
	L7315	L8315	L9315	M6	1.0	D5	3
	L7345	L8345	L9345	M7	1.0	D5	3
PIPE TAPS	L7365	L8365	L9365	M8	1.25	D5	3
	L7375	L8375	L9375	M8	1.0	D5	3
	L7426	L8426	L9426	M10	1.5	D6	3
TECHNICAL DATA	L7435	L8435	L9435	M10	1.25	D5	3
	L7506	L8506	L9506	M12	1.75	D6	3
	L7525	L8525	L9525	M12	1.25	D5	3

► For tapping depth on ANSI Length Taps, refer to MCTI 302 on page 198.

	EDP No.			SIZE	Thread Per Inch		Limit	No. of Flute
	Bright	TiN	Hardslick		UNC	UNF		
FORMING TAPS	L3082	L4082	L5082	2	56	—	H2	2
	L3162	L4162	L5162	4	40	—	H2	2
	L3202	L4202	L5202	5	40	—	H2	3
SCREW THREAD INSERT TAPS	L3243	L4243	L5243	6	32	—	H3	3
	L3283	L4283	L5283	8	32	—	H3	3
	L3323	L4323	L5323	10	24	—	H3	3
PIPE TAPS	L3343	L4343	L5343	10	—	32	H3	3
	L3403	L4403	L5403	1/4	20	—	H3	3
	L3405	L4405	L5405	1/4	20	—	H5	3
TECHNICAL DATA	L3423	L4423	L5423	1/4	—	28	H3	3
	L3443	L4443	L5443	5/16	18	—	H3	3
	L3445	L4445	L5445	5/16	18	—	H5	3
TECHNICAL DATA	L3463	L4463	L5463	5/16	—	24	H3	3
	L3483	L4483	L5483	3/8	16	—	H3	3
	L3485	L4485	L5485	3/8	16	—	H5	3
TECHNICAL DATA	L3503	L4503	L5503	3/8	—	24	H3	3
	L3523	L4523	L5523	7/16	14	—	H3	3
	L3525	L4525	L5525	7/16	14	—	H5	3
TECHNICAL DATA	L3543	L4543	L5543	7/16	—	20	H3	3
	L3545	L4545	L5545	7/16	—	20	H5	3
	L3563	L4563	L5563	1/2	13	—	H3	3
TECHNICAL DATA	L3565	L4565	L5565	1/2	13	—	H5	3
	L3583	L4583	L5583	1/2	—	20	H3	3
	L3585	L4585	L5585	1/2	—	20	H5	3
TECHNICAL DATA	L3605	L4605	L5605	9/16	12	—	H5	3
	L3625	L4625	L5625	9/16	—	18	H5	3
	L3643	L4643	L5643	5/8	11	—	H3	3
TECHNICAL DATA	L3645	L4645	L5645	5/8	11	—	H5	3
	L3703	L4703	L5703	3/4	10	—	H3	3
	L3705	L4705	L5705	3/4	10	—	H5	3
TECHNICAL DATA	L3725	L4725	L5725	3/4	—	16	H5	3
	L3746	L4746	L5746	7/8	9	—	H6	3
	L3766	L4766	L5766	7/8	—	14	H6	3
TECHNICAL DATA	L3786	L4786	L5786	1	8	—	H6	3
	L3806	L4806	L5806	1	—	12	H6	3

► For tapping depth on DIN / ANSI Shank Taps, refer to DIN Table on page 199 & 200.

© : Excellent ○ : Good

Low carbon steels / Free machining carbon steels	Medium to high carbon steels / Low alloyed steels	Steel castings & forgings / Heat-treatable alloy steels	Alloyed tool steels / Mold steels	Free machining stainless steels	Heat-and corrosionresistant stainless steels / Valve stainless steels	Stainless steel castings / Precipitation hardening stainless steels	Pure Aluminum / Aluminum alloys			
◎	◎	○		○	○					
Aluminum alloy castings	Grey cast iron	Nodular cast iron / Chilled cast iron / Meehanite iron / Ductile iron	718 & 625 INCO / Waspaloy / Hastelloy / Invar / Monel / Incoloy	718 Inconel / A286	Titanium	Pure and alloyed copper	Free machining brass / Alloyed brass	Bronze	Zinc	Magnesium
○		○								

Low carbon steels / Free machining carbon steels	Medium to high carbon steels / Low alloyed steels	Steel castings & forgings / Heat-treatable alloy steels	Alloyed tool steels / Mold steels	Free machining stainless steels	Heat-and corrosionresistant stainless steels / Valve stainless steels	Stainless steel castings / Precipitation hardening stainless steels	Pure Aluminum / Aluminum alloys			
◎	◎	○		○	○					
Aluminum alloy castings	Grey cast iron	Nodular cast iron / Chilled cast iron / Meehanite iron / Ductile iron	718 & 625 INCO / Waspaloy / Hastelloy / Invar / Monel / Incoloy	718 Inconel / A286	Titanium	Pure and alloyed copper	Free machining brass / Alloyed brass	Bronze	Zinc	Magnesium
○		○								

SPIRAL POINT TAPS

T7216/T6216/T8216 SERIES

T7C16/T6C16/T8C16 SERIES

SPIRAL POINT TAPS

T7216/T6216/T8216 SERIES

T7C16/T6C16/T8C16 SERIES

STANDARD TAPS : SPIRAL POINT PLUG STYLE for General Purpose

STANDARD TAPS : SPIRAL POINT PLUG STYLE for General Purpose

Hole type 3.0xD

Hole type 3.0xD



USCTI

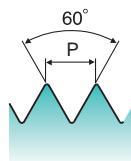

USCTI

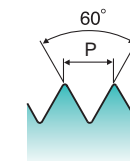

GS
HSS
UNC UNF
USCTI 302
H1-H7
60°
4P-5P
Bright
Steam Oxide
TiN

GS
HSS
UNC UNF
USCTI 302
H1-H7
60°
4P-5P
Bright
Steam Oxide
TiN

EDP No.	Thread Per Inch			Limit	No. of Flute		
	Bright	Steam Oxide	TiN				
T7216021	T6216021	T8216021	0	—	80	H1	2
T7216022	T6216022	T8216022	0	—	80	H2	2
T7216023	T6216023	T8216023	0	—	80	H3	2
T7216041	T6216041	T8216041	1	64	—	H1	2
T7216042	T6216042	T8216042	1	64	—	H2	2
T7216061	T6216061	T8216061	1	—	72	H1	2
T7216062	T6216062	T8216062	1	—	72	H2	2
T7216081	T6216081	T8216081	2	56	—	H1	2
T7216082	T6216082	T8216082	2	56	—	H2	2
T7216083	T6216083	T8216083	2	56	—	H3	2
T7216085	T6216085	T8216085	2	56	—	H5	2
T7216101	T6216101	T8216101	2	—	64	H1	2
T7216102	T6216102	T8216102	2	—	64	H2	2
T7216121	T6216121	T8216121	3	48	—	H1	2
T7216122	T6216122	T8216122	3	48	—	H2	2
T7216123	T6216123	T8216123	3	48	—	H3	2
T7216125	T6216125	T8216125	3	48	—	H5	2
T7216141	T6216141	T8216141	3	—	56	H1	2
T7216142	T6216142	T8216142	3	—	56	H2	2
T7216161	T6216161	T8216161	4	40	—	H1	2
T7216162	T6216162	T8216162	4	40	—	H2	2
T7216163	T6216163	T8216163	4	40	—	H3	2
T7216165	T6216165	T8216165	4	40	—	H5	2
T7216167	T6216167	T8216167	4	40	—	H7	2
T7216181	T6216181	T8216181	4	—	48	H1	2
T7216182	T6216182	T8216182	4	—	48	H2	2
T7216201	T6216201	T8216201	5	40	—	H1	2
T7216202	T6216202	T8216202	5	40	—	H2	2
T7216205	T6216205	T8216205	5	40	—	H5	2
T7216222	T6216222	T8216222	5	—	44	H2	2
T7216241	T6216241	T8216241	6	32	—	H1	2
T7216242	T6216242	T8216242	6	32	—	H2	2

► For tapping depth on ANSI Length Taps, refer to MCTI 302 on page 201.

► NEXT PAGE

◎ : Excellent ○ : Good

Low carbon steels / Free machining carbon steels	Medium to high carbon steels / Low alloyed steels	Steel castings & forgings / Heat-treatable alloy steels	Alloyed tool steels / Mold steels	Free machining stainless steels	Heat-and corrosionresistant stainless steels / Valve stainless steels	Stainless steel castings / Precipitation hardening stainless steels	Pure Aluminum / Aluminum alloys			
◎	◎	○		○	○					
Aluminum alloy castings	Grey cast iron	Nodular cast iron / Chilled cast iron / Meehanite iron / Ductile iron	718 & 625 INCO / Waspaloy / Hastelloy / Invar / Monel / Incoloy	718 Inconel / A286	Titanium	Pure and alloyed copper	Free machining brass / Alloyed brass	Bronze	Zinc	Magnesium
○		○								

EDP No.	Thread Per Inch			Limit	No. of Flute		
	Bright	Steam Oxide	TiN				
T7216243	T6216243	T8216243	6	32	—	H3	2
T7216244	T6216244	T8216244	6	32	—	H4	2
T7216245	T6216245	T8216245	6	32	—	H5	2
T7216247	T6216247	T8216247	6	32	—	H7	2
T7C16243	T6C16243	T8C16243	6	32	—	H3	3
T7216261	T6216261	T8216261	6	—	40	H1	2
T7216262	T6216262	T8216262	6	—	40	H2	2
T7216265	T6216265	T8216265	6	—	40	H5	2
T7216281	T6216281	T8216281	8	32	—	H1	2
T7216282	T6216282	T8216282	8	32	—	H2	2
T7216283	T6216283	T8216283	8	32	—	H3	2
T7216284	T6216284	T8216284	8	32	—	H4	2
T7216285	T6216285	T8216285	8	32	—	H5	2
T7216287	T6216287	T8216287	8	32	—	H7	2
T7C16283	T6C16283	T8C16283	8	32	—	H3	3
T7216301	T6216301	T8216301	8	—	36	H1	2
T7216302	T6216302	T8216302	8	—	36	H2	2
T7216321	T6216321	T8216321	10	24	—	H1	2
T7216322	T6216322	T8216322	10	24	—	H2	2
T7216323	T6216323	T8216323	10	24	—	H3	2
T7216324	T6216324	T8216324	10	24	—	H4	2
T7216325	T6216325	T8216325	10	24	—	H5	2
T7216327	T6216327	T8216327	10	24	—	H7	2
T7C16323	T6C16323	T8C16323	10	24	—	H3	3
T7216341	T6216341	T8216341	10	—	32	H1	2
T7216342	T6216342	T8216342	10	—	32	H2	2
T7216343	T6216343	T8216343	10	—	32	H3	2
T7216344	T6216344	T8216344	10	—	32	H4	2
T7216345	T6216345	T8216345	10	—	32	H5	2
T7216347	T6216347	T8216347	10	—	32	H7	2
T7C16343	T6C16343	T8C16343	10	—	32	H3	3
T7216361	T6216361	T8216361	12	24	—	H1	2

► For tapping depth on ANSI Length Taps, refer to MCTI 302 on page 201.

► NEXT PAGE

◎ : Excellent ○ : Good

Low carbon steels / Free machining carbon steels	Medium to high carbon steels / Low alloyed steels	Steel castings & forgings / Heat-treatable alloy steels	Alloyed tool steels / Mold steels	Free machining stainless steels	Heat-and corrosionresistant stainless steels / Valve stainless steels	Stainless steel castings / Precipitation hardening stainless steels	Pure Aluminum / Aluminum alloys			
◎	◎	○		○	○					
Aluminum alloy castings	Grey cast iron	Nodular cast iron / Chilled cast iron / Meehanite iron / Ductile iron	718 & 625 INCO / Waspaloy / Hastelloy / Invar / Monel / Incoloy	718 Inconel / A286	Titanium	Pure and alloyed copper	Free machining brass / Alloyed brass	Bronze	Zinc	Magnesium
○		○								

Y/G SPIRAL POINT TAPS

T7216/T6216/T8216 SERIES

T7C16/T6C16/T8C16 SERIES

Y/G SPIRAL POINT TAPS

T7216/T6216/T8216 SERIES

T7C16/T6C16/T8C16 SERIES

STANDARD TAPS : SPIRAL POINT PLUG STYLE for General Purpose

STANDARD TAPS : SPIRAL POINT PLUG STYLE for General Purpose

Hole type 3.0xD

Hole type 3.0xD



USCTI

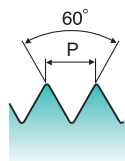

USCTI

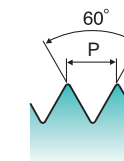

GS HSS UNC UNF USCTI 302 H1-H7 60° 4P-5P Bright Steam Oxide TiN

GS HSS UNC UNF USCTI 302 H1-H7 60° 4P-5P Bright Steam Oxide TiN

EDP No.	Thread Per Inch			Limit	No. of Flute	
	Bright	Steam Oxide	TiN			
T7216363	T6216363	T8216363	12	24	H3	2
T7216383	T6216383	T8216383	12	—	H3	2
T7216401	T6216401	T8216401	1/4	20	H1	2
T7216402	T6216402	T8216402	1/4	20	H2	2
T7216403	T6216403	T8216403	1/4	20	H3	2
T7216405	T6216405	T8216405	1/4	20	H5	2
T7C16403	T6C16403	T8C16403	1/4	20	H3	3
T7C16405	T6C16405	T8C16405	1/4	20	H5	3
T7216421	T6216421	T8216421	1/4	—	H1	2
T7216422	T6216422	T8216422	1/4	—	H2	2
T7216423	T6216423	T8216423	1/4	—	H3	2
T7216424	T6216424	T8216424	1/4	—	H4	2
T7C16422	T6C16422	T8C16422	1/4	—	H2	3
T7C16424	T6C16424	T8C16424	1/4	—	H4	3
T7216441	T6216441	T8216441	5/16	18	H1	2
T7216442	T6216442	T8216442	5/16	18	H2	2
T7216443	T6216443	T8216443	5/16	18	H3	2
T7216445	T6216445	T8216445	5/16	18	H5	2
T7C16443	T6C16443	T8C16443	5/16	18	H3	3
T7C16445	T6C16445	T8C16445	5/16	18	H5	3
T7216461	T6216461	T8216461	5/16	—	H1	2
T7216462	T6216462	T8216462	5/16	—	H2	2
T7216463	T6216463	T8216463	5/16	—	H3	2
T7216464	T6216464	T8216464	5/16	—	H4	2
T7C16462	T6C16462	T8C16462	5/16	—	H2	3
T7C16464	T6C16464	T8C16464	5/16	—	H4	3
T7216481	T6216481	T8216481	3/8	16	H1	3
T7216482	T6216482	T8216482	3/8	16	H2	3
T7216483	T6216483	T8216483	3/8	16	H3	3
T7216485	T6216485	T8216485	3/8	16	H5	3
T7216501	T6216501	T8216501	3/8	—	H1	3
T7216502	T6216502	T8216502	3/8	—	H2	3

EDP No.	Thread Per Inch			Limit	No. of Flute	
	Bright	Steam Oxide	TiN			
T7216503	T6216503	T8216503	3/8	—	H3	3
T7216504	T6216504	T8216504	3/8	—	H4	3
T7216522	T6216522	T8216522	7/16	14	H2	3
T7216523	T6216523	T8216523	7/16	14	H3	3
T7216525	T6216525	T8216525	7/16	14	H5	3
T7216542	T6216542	T8216542	7/16	—	H2	3
T7216543	T6216543	T8216543	7/16	—	H3	3
T7216545	T6216545	T8216545	7/16	—	H5	3
T7216561	T6216561	T8216561	1/2	13	H1	3
T7216562	T6216562	T8216562	1/2	13	H2	3
T7216563	T6216563	T8216563	1/2	13	H3	3
T7216565	T6216565	T8216565	1/2	13	H5	3
T7216581	T6216581	T8216581	1/2	—	H1	3
T7216582	T6216582	T8216582	1/2	—	H2	3
T7216583	T6216583	T8216583	1/2	—	H3	3
T7216585	T6216585	T8216585	1/2	—	H5	3
T7216603	T6216603	T8216603	9/16	12	H3	3
T7216605	T6216605	T8216605	9/16	12	H5	3
T7216623	T6216623	T8216623	9/16	—	H3	3
T7216625	T6216625	T8216625	9/16	—	H5	3
T7216643	T6216643	T8216643	5/8	11	H3	3
T7216645	T6216645	T8216645	5/8	11	H5	3
T7216663	T6216663	T8216663	5/8	—	H3	3
T7216665	T6216665	T8216665	5/8	—	H5	3
T7216703	T6216703	T8216703	3/4	10	H3	3
T7216705	T6216705	T8216705	3/4	10	H5	3
T7216723	T6216723	T8216723	3/4	—	H3	3
T7216725	T6216725	T8216725	3/4	—	H5	3

► For tapping depth on ANSI Length Taps, refer to MCTI 302 on page 201.

► For tapping depth on ANSI Length Taps, refer to MCTI 302 on page 201.

► NEXT PAGE

◎ : Excellent ○ : Good

◎ : Excellent ○ : Good

Low carbon steels / Free machining carbon steels	Medium to high carbon steels / Low alloyed steels	Steel castings & forgings / Heat-treatable alloy steels	Alloyed tool steels / Mold steels	Free machining stainless steels	Heat-and corrosionresistant stainless steels / Valve stainless steels	Stainless steel castings / Precipitation hardening stainless steels	Pure Aluminum / Aluminum alloys			
◎	◎	○		○	○					
Aluminum alloy castings	Grey cast iron	Nodular cast iron / Meehanite iron / Ductile iron	718 & 625 INCO / Waspaloy / Hastelloy / Invar / Monel / Incoloy	718 Inconel / A286	Titanium	Pure and alloyed copper	Free machining brass / Alloyed brass	Bronze	Zinc	Magnesium
○		○								

Low carbon steels / Free machining carbon steels	Medium to high carbon steels / Low alloyed steels	Steel castings & forgings / Heat-treatable alloy steels	Alloyed tool steels / Mold steels	Free machining stainless steels	Heat-and corrosionresistant stainless steels / Valve stainless steels	Stainless steel castings / Precipitation hardening stainless steels	Pure Aluminum / Aluminum alloys			
◎	◎	○		○	○					
Aluminum alloy castings	Grey cast iron	Nodular cast iron / Meehanite iron / Ductile iron	718 & 625 INCO / Waspaloy / Hastelloy / Invar / Monel / Incoloy	718 Inconel / A286	Titanium	Pure and alloyed copper	Free machining brass / Alloyed brass	Bronze	Zinc	Magnesium
○		○								

YG SPIRAL POINT TAPS

T7256/T6256 SERIES

YG SPIRAL POINT TAPS

T7256/T6256 SERIES

STANDARD TAPS : SPIRAL POINT BOTTOMING STYLE for General Purpose

STANDARD TAPS : SPIRAL POINT BOTTOMING STYLE for General Purpose

Hole type 3.0xD

Hole type 3.0xD

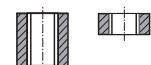
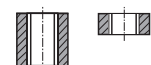
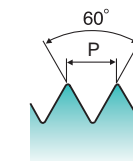
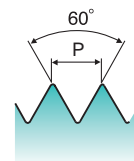

USCTI

USCTI

GS HSS UNC UNF USCTI 302 H1-H7 Bright Steam Oxide

GS HSS UNC UNF USCTI 302 H1-H7 Bright Steam Oxide

EDP No.	SIZE	Thread Per Inch		Limit	No. of Flute	
		Bright	Steam Oxide			UNC
T7256021	0	T6256021	—	80	H1	2
T7256022	0	T6256022	—	80	H2	2
T7256042	1	T6256042	64	—	H2	2
T7256061	1	T6256061	—	72	H1	2
T7256062	1	T6256062	—	72	H2	2
T7256081	2	T6256081	56	—	H1	2
T7256082	2	T6256082	56	—	H2	2
T7256122	3	T6256122	48	—	H2	2
T7256142	3	T6256142	—	56	H2	2
T7256162	4	T6256162	40	—	H2	2
T7256182	4	T6256182	—	48	H2	2
T7256202	5	T6256202	40	—	H2	2
T7256222	5	T6256222	—	44	H2	2
T7256242	6	T6256242	32	—	H2	2
T7256243	6	T6256243	32	—	H3	2
T7256247	6	T6256247	32	—	H7	2
T7256262	6	T6256262	—	40	H2	2
T7256282	8	T6256282	32	—	H2	2
T7256283	8	T6256283	32	—	H3	2
T7256287	8	T6256287	32	—	H7	2
T7256302	8	T6256302	—	36	H2	2
T7256322	10	T6256322	24	—	H2	2
T7256323	10	T6256323	24	—	H3	2
T7256341	10	T6256341	—	32	H1	2
T7256342	10	T6256342	—	32	H2	2
T7256343	10	T6256343	—	32	H3	2
T7256363	12	T6256363	24	—	H3	2
T7256383	12	T6256383	—	28	H3	2
T7256403	1/4	T6256403	20	—	H3	2
T7256422	1/4	T6256422	—	28	H2	2
T7256423	1/4	T6256423	—	28	H3	2
T7256443	5/16	T6256443	18	—	H3	2

EDP No.	SIZE	Thread Per Inch		Limit	No. of Flute	
		Bright	Steam Oxide			UNC
T7256463	5/16	T6256463	—	24	H3	2
T7256483	3/8	T6256483	16	—	H3	3
T7256503	3/8	T6256503	—	24	H3	3
T7256523	7/16	T6256523	14	—	H3	3
T7256543	7/16	T6256543	—	20	H3	3
T7256563	1/2	T6256563	13	—	H3	3
T7256583	1/2	T6256583	—	20	H3	3
T7256643	5/8	T6256643	11	—	H3	3
T7256663	5/8	T6256663	—	18	H3	3
T7256703	3/4	T6256703	10	—	H3	3
T7256723	3/4	T6256723	—	16	H3	3

► For tapping depth on ANSI Length Taps, refer to MCTI 302 on page 201.

► For tapping depth on ANSI Length Taps, refer to MCTI 302 on page 201.

► NEXT PAGE

◎ : Excellent ○ : Good

◎ : Excellent ○ : Good

Low carbon steels / Free machining carbon steels	Medium to high carbon steels / Low alloyed steels	Steel castings & forgings / Heat-treatable alloy steels	Alloyed tool steels / Mold steels	Free machining stainless steels	Heat-and corrosionresistant stainless steels / Valve stainless steels	Stainless steel castings / Precipitation hardening stainless steels	Pure Aluminum / Aluminum alloys			
◎	◎	○		○	○					
Aluminum alloy castings	Grey cast iron	Nodular cast iron / Chilled cast iron / Meehanite iron / Ductile iron	718 & 625 INCO / Waspaloy / Hastelloy / Invar / Monel / Incoloy	718 Inconel / A286	Titanium	Pure and alloyed copper	Free machining brass / Alloyed brass	Bronze	Zinc	Magnesium
○		○								

Low carbon steels / Free machining carbon steels	Medium to high carbon steels / Low alloyed steels	Steel castings & forgings / Heat-treatable alloy steels	Alloyed tool steels / Mold steels	Free machining stainless steels	Heat-and corrosionresistant stainless steels / Valve stainless steels	Stainless steel castings / Precipitation hardening stainless steels	Pure Aluminum / Aluminum alloys			
◎	◎	○		○	○					
Aluminum alloy castings	Grey cast iron	Nodular cast iron / Chilled cast iron / Meehanite iron / Ductile iron	718 & 625 INCO / Waspaloy / Hastelloy / Invar / Monel / Incoloy	718 Inconel / A286	Titanium	Pure and alloyed copper	Free machining brass / Alloyed brass	Bronze	Zinc	Magnesium
○		○								

YG SPIRAL POINT TAPS

T7217/T6217/T8217 SERIES

YG SPIRAL POINT TAPS

T7226/T6226/T8226 SERIES

METRIC STANDARD TAPS : SPIRAL POINT PLUG STYLE for General Purpose

STANDARD TAPS : SPIRAL POINT PLUG STYLE Oversize Tap

Hole type 3.0xD

Hole type 3.0xD

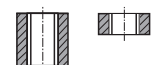
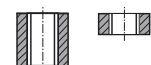
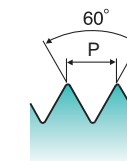
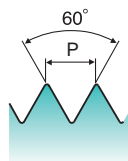

USCTI

USCTI

GS HSS M MF USCTI 302 D3-D7 Bright Steam Oxide TiN

GS HSS UNC UNF USCTI 302 Bright Steam Oxide TiN +.005" oversize

	EDP No.			SIZE	Pitch	Thread Limit	No. of Flute
	Bright	Steam Oxide	TiN				
	T7217093	T6217093	T8217093	M1.6	0.35	D3	2
	T7217133	T6217133	T8217133	M2	0.40	D3	2
	T7217173	T6217173	T8217173	M2.5	0.45	D3	2
	T7217203	T6217203	T8217203	M3	0.50	D3	2
	T7217224	T6217224	T8217224	M3.5	0.60	D4	2
	T7217244	T6217244	T8217244	M4	0.70	D4	2
	T7217264	T6217264	T8217264	M4.5	0.75	D4	2
	T7217284	T6217284	T8217284	M5	0.80	D4	2
	T7217315	T6217315	T8217315	M6	1.00	D5	2
	T7217345	T6217345	T8217345	M7	1.00	D5	2
	T7217365	T6217365	T8217365	M8	1.25	D5	2
	T7217375	T6217375	T8217375	M8	1.00	D5	3
	T7217426	T6217426	T8217426	M10	1.50	D6	3
	T7217435	T6217435	T8217435	M10	1.25	D5	3
	T7217506	T6217506	T8217506	M12	1.75	D6	3
	T7217525	T6217525	T8217525	M12	1.25	D5	3
	T7217547	T6217547	T8217547	M14	2.00	D7	3
	T7217556	T6217556	T8217556	M14	1.50	D6	3
	T7217607	T6217607	T8217607	M16	2.00	D7	3
	T7217616	T6217616	T8217616	M16	1.50	D6	3
	T7217657	T6217657	T8217657	M18	2.50	D7	3
	T7217707	T6217707	T8217707	M20	2.50	D7	3

	EDP No.			SIZE	Thread Per Inch		No. of Flute
	Bright	Steam Oxide	TiN		UNC	UNF	
	T7226240	T6226240	T8226240	6	32	—	2
	T7226280	T6226280	T8226280	8	32	—	2
	T7226320	T6226320	T8226320	10	24	—	2
	T7226340	T6226340	T8226340	10	—	32	2
	T7226400	T6226400	T8226400	1/4	20	—	2
	T7226420	T6226420	T8226420	1/4	—	28	2
	T7226440	T6226440	T8226440	5/16	18	—	2
	T7226460	T6226460	T8226460	5/16	—	24	2
	T7226480	T6226480	T8226480	3/8	16	—	3
	T7226500	T6226500	T8226500	3/8	—	24	3
	T7226520	T6226520	T8226520	7/16	14	—	3
	T7226540	T6226540	T8226540	7/16	—	20	3
	T7226560	T6226560	T8226560	1/2	13	—	3
	T7226580	T6226580	T8226580	1/2	—	20	3
	T7226640	T6226640	T8226640	5/8	11	—	3
	T7226700	T6226700	T8226700	3/4	10	—	3

► For tapping depth on ANSI Length Taps, refer to MCTI 302 on page 201.

► For tapping depth on ANSI Length Taps, refer to MCTI 302 on page 201.

◎ : Excellent ○ : Good

◎ : Excellent ○ : Good

Low carbon steels/ Free machining carbon steels	Medium to high carbon steels/ Low alloyed steels	Steel castings & forgings / Heat-treatable alloy steels	Alloyed tool steels / Mold steels	Free machining stainless steels	Heat-and corrosionresistant stainless steels / Valve stainless steels	Stainless steel castings / Precipitation hardening stainless steels	Pure Aluminum/ Aluminum alloys				
◎	◎	○		○	○						
Aluminum alloy castings	Grey cast iron	Nodular cast iron / Chilled cast iron / Meehanite iron / Ductile iron	718 & 625 INCO / Waspaloy / Hastelloy / Invar / Monel / Incoloy	718 Inconel / A286	Titanium	Pure and alloyed copper	Free machining brass / Alloyed brass	Bronze	Zinc	Magnesium	
○		○									

Low carbon steels/ Free machining carbon steels	Medium to high carbon steels/ Low alloyed steels	Steel castings & forgings / Heat-treatable alloy steels	Alloyed tool steels / Mold steels	Free machining stainless steels	Heat-and corrosionresistant stainless steels / Valve stainless steels	Stainless steel castings / Precipitation hardening stainless steels	Pure Aluminum/ Aluminum alloys				
◎	◎	○		○	○						
Aluminum alloy castings	Grey cast iron	Nodular cast iron / Chilled cast iron / Meehanite iron / Ductile iron	718 & 625 INCO / Waspaloy / Hastelloy / Invar / Monel / Incoloy	718 Inconel / A286	Titanium	Pure and alloyed copper	Free machining brass / Alloyed brass	Bronze	Zinc	Magnesium	
○		○									

YG SPIRAL POINT TAPS

T7B17/T6B17/T8B17 SERIES

YG SPIRAL POINT TAPS

T7236/T6236/T8236 SERIES

T7G36/T6G36/T8G36 SERIES

STANDARD TAPS : SPIRAL POINT PLUG STYLE
Oversize Tap

SPIRAL POINTED TAP, 6" EXTENSION

Hole type 3.0xD

Hole type 3.0xD



USCTI

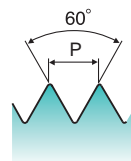

USCTI Long Shank

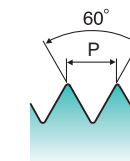

GS HSS M MF USCTI 302 60° 4P~5P Bright Steam Oxide TiN + .127mm oversize

GS HSS UNC UNF USCTI Long Shank H3 60° 4P~5P Bright Steam Oxide TiN

	EDP No.			SIZE	Pitch	No. of Flute
	Bright	Steam Oxide	TiN			
	T7B17240	T6B17240	T8B17240	M4	0.7	2
	T7B17280	T6B17280	T8B17280	M5	0.8	2
	T7B17310	T6B17310	T8B17310	M6	1	2
	T7B17360	T6B17360	T8B17360	M8	1.25	2
	T7B17370	T6B17370	T8B17370	M8	1	2
	T7B17420	T6B17420	T8B17420	M10	1.5	3
	T7B17430	T6B17430	T8B17430	M10	1.25	3
	T7B17500	T6B17500	T8B17500	M12	1.75	3
	T7B17600	T6B17600	T8B17600	M16	2	3

► For tapping depth on ANSI Length Taps, refer to MCTI 302 on page 201.

	EDP No.			SIZE	Thread Per Inch		Thread Limit	Overall Length	No. of Flutes
	Bright	Steam Oxide	TiN		UNC	UNF			
	T7236243	T6236243	T8236243	6	32	—	H3	6	2
	T7236283	T6236283	T8236283	8	32	—	H3	6	2
	T7236323	T6236323	T8236323	10	24	—	H3	6	2
	T7236343	T6236343	T8236343	10	—	32	H3	6	2
	T7236403	T6236403	T8236403	1/4	20	—	H3	6	2
	T7236423	T6236423	T8236423	1/4	—	28	H3	6	2
	T7236443	T6236443	T8236443	5/16	18	—	H3	6	2
	T7G36443	T6G36443	T8G36443	5/16	18	—	H3	6	3
	T7236463	T6236463	T8236463	5/16	—	24	H3	6	2
	T7G36463	T6G36463	T8G36463	5/16	—	24	H3	6	3
	T7236483	T6236483	T8236483	3/8	16	—	H3	6	3
	T7236503	T6236503	T8236503	3/8	—	24	H3	6	3
	T7236523	T6236523	T8236523	7/16	14	—	H3	6	3
	T7236543	T6236543	T8236543	7/16	—	20	H3	6	3
	T7236563	T6236563	T8236563	1/2	13	—	H3	6	3
	T7236583	T6236583	T8236583	1/2	—	20	H3	6	3
	T7236643	T6236643	T8236643	5/8	11	—	H3	6	3

► For tapping depth on DIN / ANSI Shank Taps, refer to DIN Table on page 199 & 200.

◎ : Excellent ○ : Good

Low carbon steels/ Free machining carbon steels	Medium to high carbon steels/ Low alloyed steels	Steel castings & forgings / Heat-treatable alloy steels	Alloyed tool steels / Mold steels	Free machining stainless steels	Heat-and corrosionresistant stainless steels / Valve stainless steels	Stainless steel castings / Precipitation hardening stainless steels	Pure Aluminum/ Aluminum alloys			
◎	◎	○		○	○					
Aluminum alloy castings	Grey cast iron	Nodular cast iron / Chilled cast iron / Meehanite iron / Ductile iron	718 & 625 INCO / Waspaloy / Hastelloy / Invar / Monel / Incoloy	718 Inconel / A286	Titanium	Pure and alloyed copper	Free machining brass / Alloyed brass	Bronze	Zinc	Magnesium
○		○								

◎ : Excellent ○ : Good

Low carbon steels/ Free machining carbon steels	Medium to high carbon steels/ Low alloyed steels	Steel castings & forgings / Heat-treatable alloy steels	Alloyed tool steels / Mold steels	Free machining stainless steels	Heat-and corrosionresistant stainless steels / Valve stainless steels	Stainless steel castings / Precipitation hardening stainless steels	Pure Aluminum/ Aluminum alloys			
◎	◎	○		○	○					
Aluminum alloy castings	Grey cast iron	Nodular cast iron / Chilled cast iron / Meehanite iron / Ductile iron	718 & 625 INCO / Waspaloy / Hastelloy / Invar / Monel / Incoloy	718 Inconel / A286	Titanium	Pure and alloyed copper	Free machining brass / Alloyed brass	Bronze	Zinc	Magnesium
○		○								



CARBIDE & HSS

Being the best through innovation



STRAIGHT FLUTE TAPS

- Tapping Through & Blind Holes / Carbide, Super HSS & HSS

Global Cutting Tool Leader **YG-1**

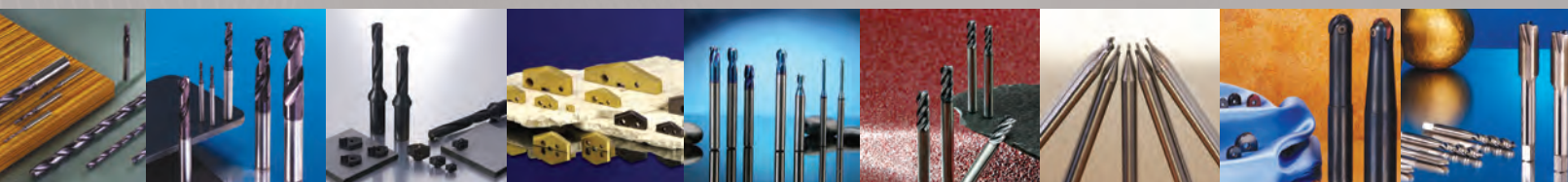

SELECTION GUIDE

STRAIGHT FLUTE TAPS

Tapping Through & Blind Holes / Carbide, Super HSS & HSS

INCH

EDP No.	MODEL	Tool Material	Standard	Work Material	Dimensions	Tolerance	Chamfer	Thread Depth	Surface Treatment	Page
TOC01		Carbide	UNC/UNF	GG	USCTI 302A	2B	1.5 ~ 2P	2.0D	Bright	147
TR		Super HSS	UNC/UNF	GG	USCTI 302A	H3~H5	2 ~ 3P		TiAlN	148
			M	GG		D4~D6	2 ~ 3P			
TR-A, TR-R		Super HSS	UNC/UNF	GG	USCTI 302A	H3~H5	2 ~ 3P		TiAlN	150
			M	GG		D4~D6	2 ~ 3P			
T7316/T6316/ T8316/T7A16/ T7B16		HSS	UNC/ UNF/ UNS	GS	USCTI 302	H1~H7	9P/5P/2P		Bright Steam Oxide TiN	152
T7315/T6315/ T8315		HSS	M/MF	GS	USCTI 302	D3~D9	9P/5P/2P		Bright Steam Oxide TiN	158
T7326		HSS	UNC/UNF	GS	USCTI 302	+0.005" oversize	5P/2P		Bright	159
T7B15		HSS	M/MF	GS	USCTI 302	+0.127mm oversize	5P/2P		Bright	160
T7336		HSS	UNC/UNF	GS	USCTI 302 (Left Hand)	H2~H4	5P/2P		Bright	161
T7A15		HSS	UNC/UNF	GS	USCTI 302 (Left Hand)	D4~D8	5P/2P		Bright	162
T7616/T6616/ T8616		HSS	UNC/UNF	GS	USCTI Long Shank	H3	4 ~ 5P		Bright Steam Oxide TiN	163

STRAIGHT FLUTE TAPS

TOC01 SERIES

STRAIGHT FLUTE TAP BOTTOMING STYLE for ALUMINUM ALLOY & CAST IRON

Hole type 2.0xD

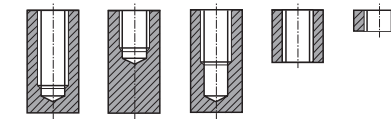

USCTI

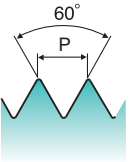

GG
Carbide
UNC UNF
USCTI 302A
2B
60°
1.5P~2P Bottoming
Bright

EDP No.	SIZE	Thread Per Inch		Thread Limit	No. of Flute
		UNC	UNF		
TOC01322	10	24	—	2B	4
TOC01342	10	—	32	2B	4
TOC01362	12	24	—	2B	4
TOC01402	1/4	20	—	2B	4
TOC01422	1/4	—	28	2B	4
TOC01442	5/16	18	—	2B	4
TOC01462	5/16	—	24	2B	4
TOC01482	3/8	16	—	2B	4
TOC01502	3/8	—	24	2B	4

► For tapping depth on ANSI Length Taps, refer to MCTI 302 on page 201.

◎ : Excellent ○ : Good

Low carbon steels/ Free machining carbon steels	Medium to high carbon steels/ Low alloyed steels	Steel castings & forgings / Heat-treatable alloy steels	Alloyed tool steels / Mold steels	Free machining stainless steels	Heat-and corrosionresistant stainless steels / Valve stainless steels	Stainless steel castings / Precipitation hardening stainless steels	Pure Aluminum/ Aluminum alloys			
◎	◎	◎								
Aluminum alloy castings	Grey cast iron	Nodular cast iron / Chilled cast iron / Meehanite iron / Ductile iron	718 & 625 INCO / Waspaloy / Hastelloy / Invar / Monel / Incoloy	718 Inconel / A286	Titanium	Pure and alloyed copper	Free machining brass / Alloyed brass	Bronze	Zinc	Magnesium
◎	◎	◎				◎				

STRAIGHT FLUTE TAPS

TR SERIES

STRAIGHT FLUTE TAPS

TR SERIES

STRAIGHT FLUTE TAP MODIFIED BOTTOMING STYLE for CAST IRON

METRIC STRAIGHT FLUTE TAP MODIFIED BOTTOMING STYLE for CAST IRON

Hole type 2.0xD

Hole type 2.0xD

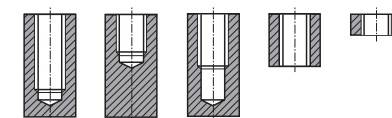
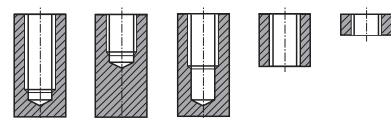

USCTI

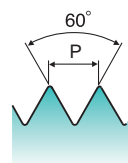

USCTI

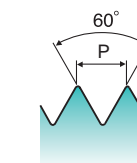

* NEW SIZE

GG Super HSS UNC UNF USCTI 302A H3~H5 60° 2P~3P Bottoming TiAIN

GG Super HSS M USCTI 302A D4~D6 60° 2P~3P Bottoming TiAIN

EDP No.	TiAIN	SIZE	Thread Per Inch		Limit	No. of Flute
			UNC	UNF		
TR323		10	24	—	H3	4
TR325		10	24	—	H5	4
TR343		10	—	32	H3	4
TR403		1/4	20	—	H3	4
TR405		1/4	20	—	H5	4
TR423		1/4	—	28	H3	4
TR443		5/16	18	—	H3	4
TR445		5/16	18	—	H5	4
TR463		5/16	—	24	H3	4
TR483		3/8	16	—	H3	4
TR485		3/8	16	—	H5	4
TR503		3/8	—	24	H3	4
TR523		7/16	14	—	H3	4
TR525		7/16	14	—	H5	4
TR543		7/16	—	20	H3	4
TR545		7/16	—	20	H5	4
TR563		1/2	13	—	H3	4
TR565		1/2	13	—	H5	4
TR583		1/2	—	20	H3	4
TR585		1/2	—	20	H5	4
TR603		9/16	12	—	H3	4
TR605		9/16	12	—	H5	4
TR623		9/16	—	18	H3	4
TR625		9/16	—	18	H5	4
TR643		5/8	11	—	H3	4
TR645		5/8	11	—	H5	4
TR663		5/8	—	18	H3	4
TR665		5/8	—	18	H5	4
TR703		3/4	10	—	H3	4
TR705		3/4	10	—	H5	4
TR723		3/4	—	16	H3	4
TR725		3/4	—	16	H5	4

EDP No.	TiAIN	SIZE	Pitch	Limit	No. of Flute
TR315		M6	1	D5	4
TR365		M8	1.25	D5	4
TR426		M10	1.5	D6	4
TR526		M12	1.25	D6	4
TR506		M12	1.75	D6	4
TR566		M14	1.25	D6	4
TR556		M14	1.5	D6	4
* TR616		M16	1.5	D6	4
TR676		M18	1.5	D6	4

► For tapping depth on ANSI Length Taps, refer to MCTI 302 on page 201.

► For tapping depth on ANSI Length Taps, refer to MCTI 302 on page 201.

► NEXT PAGE

◎ : Excellent ○ : Good

◎ : Excellent ○ : Good

Low carbon steels / Free machining carbon steels	Medium to high carbon steels / Low alloyed steels	Steel castings & forgings / Heat-treatable alloy steels	Alloyed tool steels / Mold steels	Free machining stainless steels	Heat-and corrosionresistant stainless steels / Valve stainless steels	Stainless steel castings / Precipitation hardening stainless steels	Pure Aluminum / Aluminum alloys							
Aluminum alloy castings	Grey cast iron	Nodular cast iron / Chilled cast iron / Meehanite iron / Ductile iron	718 & 625 INCO / Waspaloy / Hastelloy / Invar / Monel / Incoloy	718 Inconel / A286	Titanium	Pure and alloyed copper	Free machining brass / Alloyed brass	Bronze	Zinc	Magnesium				
◎	◎													

Low carbon steels / Free machining carbon steels	Medium to high carbon steels / Low alloyed steels	Steel castings & forgings / Heat-treatable alloy steels	Alloyed tool steels / Mold steels	Free machining stainless steels	Heat-and corrosionresistant stainless steels / Valve stainless steels	Stainless steel castings / Precipitation hardening stainless steels	Pure Aluminum / Aluminum alloys							
Aluminum alloy castings	Grey cast iron	Nodular cast iron / Chilled cast iron / Meehanite iron / Ductile iron	718 & 625 INCO / Waspaloy / Hastelloy / Invar / Monel / Incoloy	718 Inconel / A286	Titanium	Pure and alloyed copper	Free machining brass / Alloyed brass	Bronze	Zinc	Magnesium				
◎	◎													

STRAIGHT FLUTE TAPS

TR-A, TR-R SERIES

STRAIGHT FLUTE TAPS

TR-A, TR-R SERIES

STRAIGHT FLUTE TAP MODIFIED BOTTOMING STYLE for CAST IRON

METRIC STRAIGHT FLUTE TAP MODIFIED BOTTOMING STYLE for CAST IRON

Hole type 2.0xD

Hole type 2.0xD

Through Coolant Hole

Through Coolant Hole

Radial Coolant Hole

Radial Coolant Hole

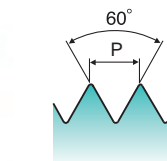
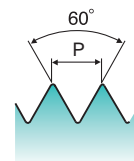
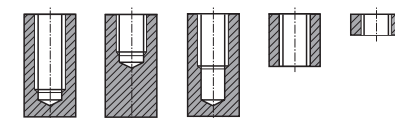
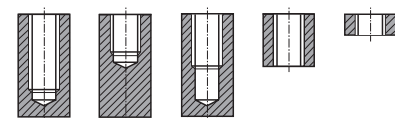

GG Super HSS UNC UNF USCTI 302A H3~H5 60° 2P~3P Bottoming TiAIN

GG Super HSS M USCTI 302A D4~D6 60° 2P~3P Bottoming TiAIN

EDP No.		SIZE	Thread Per Inch		Limit	No. of Flute
Through Coolant Hole	Radial Coolant Hole		UNC	UNF		
TR323A	TR323R	10	24	—	H3	4
TR325A	TR325R	10	24	—	H5	4
TR343A	TR343R	10	—	32	H3	4
TR403A	TR403R	1/4	20	—	H3	4
TR405A	TR405R	1/4	20	—	H5	4
TR423A	TR423R	1/4	—	28	H3	4
TR443A	TR443R	5/16	18	—	H3	4
TR445A	TR445R	5/16	18	—	H5	4
TR463A	TR463R	5/16	—	24	H3	4
TR483A	TR483R	3/8	16	—	H3	4
TR485A	TR485R	3/8	16	—	H5	4
TR503A	TR503R	3/8	—	24	H3	4
TR523A	TR523R	7/16	14	—	H3	4
TR525A	TR525R	7/16	14	—	H5	4
TR543A	TR543R	7/16	—	20	H3	4
TR545A	TR545R	7/16	—	20	H5	4
TR563A	TR563R	1/2	13	—	H3	4
TR565A	TR565R	1/2	13	—	H5	4
TR583A	TR583R	1/2	—	20	H3	4
TR585A	TR585R	1/2	—	20	H5	4
TR603A	TR603R	9/16	12	—	H3	4
TR605A	TR605R	9/16	12	—	H5	4
TR623A	TR623R	9/16	—	18	H3	4
TR625A	TR625R	9/16	—	18	H5	4
TR643A	TR643R	5/8	11	—	H3	4
TR645A	TR645R	5/8	11	—	H5	4
TR663A	TR663R	5/8	—	18	H3	4
TR665A	TR665R	5/8	—	18	H5	4
TR703A	TR703R	3/4	10	—	H3	4
TR705A	TR705R	3/4	10	—	H5	4
TR723A	TR723R	3/4	—	16	H3	4
TR725A	TR725R	3/4	—	16	H5	4

EDP No.		SIZE	Pitch	Limit	No. of Flute
Through Coolant Hole	Radial Coolant Hole				
TR284A	TR284R	M5	0.8	D4	4
TR315A	TR315R	M6	1	D5	4
TR365A	TR365R	M8	1.25	D5	4
TR426A	TR426R	M10	1.5	D6	4
TR526A	TR526R	M12	1.25	D6	4
TR506A	TR506R	M12	1.75	D6	4
TR566A	TR566R	M14	1.25	D6	4
TR556A	TR556R	M14	1.5	D6	4
* TR616A	* TR616R	M16	1.5	D6	4
TR676A	TR676R	M18	1.5	D6	4

► For tapping depth on ANSI Length Taps, refer to MCTI 302 on page 201.

► For tapping depth on ANSI Length Taps, refer to MCTI 302 on page 201.

► NEXT PAGE

◎ : Excellent ○ : Good

◎ : Excellent ○ : Good

Low carbon steels / Free machining carbon steels	Medium to high carbon steels / Low alloyed steels	Steel castings & forgings / Heat-treatable alloy steels	Alloyed tool steels / Mold steels	Free machining stainless steels	Heat-and corrosionresistant stainless steels / Valve stainless steels	Stainless steel castings / Precipitation hardening stainless steels	Pure Aluminum / Aluminum alloys				
Aluminum alloy castings	Grey cast iron	Nodular cast iron / Chilled cast iron / Meehanite iron / Ductile iron	718 & 625 INCO / Waspaloy / Hastelloy / Invar / Monel / Incoloy	718 Inconel / A286	Titanium	Pure and alloyed copper	Free machining brass / Alloyed brass	Bronze	Zinc	Magnesium	
◎	◎										

Low carbon steels / Free machining carbon steels	Medium to high carbon steels / Low alloyed steels	Steel castings & forgings / Heat-treatable alloy steels	Alloyed tool steels / Mold steels	Free machining stainless steels	Heat-and corrosionresistant stainless steels / Valve stainless steels	Stainless steel castings / Precipitation hardening stainless steels	Pure Aluminum / Aluminum alloys				
Aluminum alloy castings	Grey cast iron	Nodular cast iron / Chilled cast iron / Meehanite iron / Ductile iron	718 & 625 INCO / Waspaloy / Hastelloy / Invar / Monel / Incoloy	718 Inconel / A286	Titanium	Pure and alloyed copper	Free machining brass / Alloyed brass	Bronze	Zinc	Magnesium	
◎	◎										

STRAIGHT FLUTE TAPS

T7316/T6316/T8316 SERIES

T7A16/T7B16 SERIES

STRAIGHT FLUTE TAPS

T7316/T6316/T8316 SERIES

T7A16/T7B16 SERIES

HAND TAP TAPER, PLUG & BOTTOMING STYLE

HAND TAP TAPER, PLUG & BOTTOMING STYLE

Hole type 2.0xD

Hole type 2.0xD

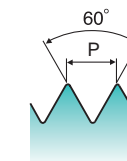
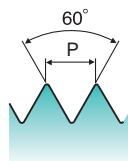
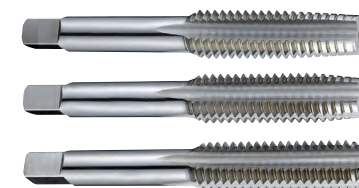
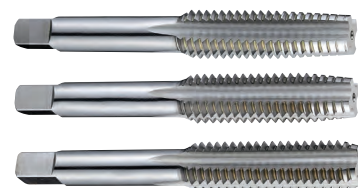
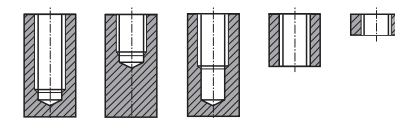
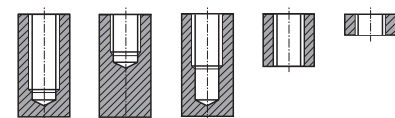

GS HSS UNC UNF UNS USCTI 302 H1-H7 60° 9P/5P/2P Bright Steam Oxide TiN

GS HSS UNC UNF UNS USCTI 302 H1-H7 60° 9P/5P/2P Bright Steam Oxide TiN

EDP No.								SIZE	Thread Per Inch			Limit	No. of Flute
Bright			Steam Oxide			TiN			UNC	UNF	UNS		
Taper	Plug	Bottoming	Taper	Plug	Bottoming	Plug	Bottoming						
T7316026	T7316027	T7316028	T6316026	T6316027	T6316028	T8316027	T8316028	0	-	80	-	H1	2
-	T7316027H2	T7316028H2	-	-	-	-	-	0	-	80	-	H2	2
T7316046	T7316047	T7316048	T6316046	T6316047	T6316048	T8316047	T8316048	1	64	-	-	H1	2
-	T7316047H2	T7316048H2	-	-	-	-	-	1	64	-	-	H2	2
T7316066	T7316067	T7316068	T6316066	T6316067	T6316068	T8316067	T8316068	1	-	72	-	H1	2
-	T7316067H2	T7316068H2	-	-	-	-	-	1	-	72	-	H2	2
-	T7A16087H1	T7A16088H1	-	-	-	-	-	2	56	-	-	H1	2
T7316086H1	T7316087H1	T7316088H1	-	-	-	-	-	2	56	-	-	H1	3
-	T7A16087	T7A16088	-	-	-	-	-	2	56	-	-	H2	2
T7316086	T7316087	T7316088	T6316086	T6316087	T6316088	T8316087	T8316088	2	56	-	-	H2	3
T7316106	T7316107	T7316108	-	-	-	-	-	2	-	64	-	H2	3
-	T7316127H1	-	-	-	-	-	-	3	48	-	-	H1	3
-	T7A16127	T7A16128	-	-	-	-	-	3	48	-	-	H2	2
T7316126	T7316127	T7316128	T6316126	T6316127	T6316128	-	-	3	48	-	-	H2	3
T7316146	T7316147	T7316148	T6316146	T6316147	T6316148	-	-	3	-	56	-	H2	3
T7316156	T7316157	T7316158	T6316156	T6316157	T6316158	-	-	4	-	-	36	H2	3
-	T7A16167H1	T7A16168H1	-	-	-	-	-	4	40	-	-	H1	2
T7316166H1	T7316167H1	T7316168H1	T6316166H1	T6316167H1	T6316168H1	-	-	4	40	-	-	H1	3
-	T7A16167	T7A16168	-	-	-	-	-	4	40	-	-	H2	2
T7316166	T7316167	T7316168	T6316166	T6316167	T6316168	T8316167	T8316168	4	40	-	-	H2	3
-	T7316187H1	-	-	-	-	-	-	4	-	48	-	H1	3
T7316186	T7316187	T7316188	-	-	-	-	-	4	-	48	-	H2	3
-	T7316207H1	T7316208H1	-	-	-	-	-	5	40	-	-	H1	3
-	T7A16207	T7A16208	-	-	-	-	-	5	40	-	-	H2	2
T7316206	T7316207	T7316208	T6316206	T6316207	T6316208	T8316207	T8316208	5	40	-	-	H2	3
T7316226	T7316227	T7316228	T6316226	T6316227	T6316228	-	-	5	-	44	-	H2	3
-	T7A16247H1	T7A16248H1	-	-	-	-	-	6	32	-	-	H1	2
T7316246H1	T7316247H1	T7316248H1	T6316246H1	T6316247H1	T6316248H1	-	-	6	32	-	-	H1	3
-	T7A16247H2	T7A16248H2	-	-	-	-	-	6	32	-	-	H2	2

► For tapping depth on ANSI Length Taps, refer to MCTI 302 on page 201.

► For tapping depth on ANSI Length Taps, refer to MCTI 302 on page 201.

► NEXT PAGE

► NEXT PAGE

◎ : Excellent ○ : Good

◎ : Excellent ○ : Good

Low carbon steels / Free machining carbon steels	Medium to high carbon steels / Low alloyed steels	Steel castings & forgings / Heat-treatable alloy steels	Alloyed tool steels / Mold steels	Free machining stainless steels	Heat-and corrosionresistant stainless steels / Valve stainless steels	Stainless steel castings / Precipitation hardening stainless steels	Pure Aluminum / Aluminum alloys			
◎	◎			◎			◎			
Aluminum alloy castings	Grey cast iron	Nodular cast iron / Chilled cast iron / Meehanite iron / Ductile iron	718 & 625 INCO / Waspaloy / Hastelloy / Invar / Monel / Incoloy	718 Inconel / A286	Titanium	Pure and alloyed copper	Free machining brass / Alloyed brass	Bronze	Zinc	Magnesium
◎						◎	◎		◎	◎

Low carbon steels / Free machining carbon steels	Medium to high carbon steels / Low alloyed steels	Steel castings & forgings / Heat-treatable alloy steels	Alloyed tool steels / Mold steels	Free machining stainless steels	Heat-and corrosionresistant stainless steels / Valve stainless steels	Stainless steel castings / Precipitation hardening stainless steels	Pure Aluminum / Aluminum alloys			
◎	◎			◎			◎			
Aluminum alloy castings	Grey cast iron	Nodular cast iron / Chilled cast iron / Meehanite iron / Ductile iron	718 & 625 INCO / Waspaloy / Hastelloy / Invar / Monel / Incoloy	718 Inconel / A286	Titanium	Pure and alloyed copper	Free machining brass / Alloyed brass	Bronze	Zinc	Magnesium
◎						◎	◎		◎	◎

STRAIGHT FLUTE TAPS

T7316/T6316/T8316 SERIES

T7A16/T7B16 SERIES

STRAIGHT FLUTE TAPS

T7316/T6316/T8316 SERIES

T7A16/T7B16 SERIES

HAND TAP TAPER, PLUG & BOTTOMING STYLE

HAND TAP TAPER, PLUG & BOTTOMING STYLE

Hole type 2.0xD

Hole type 2.0xD

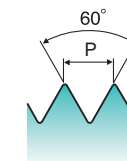
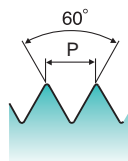
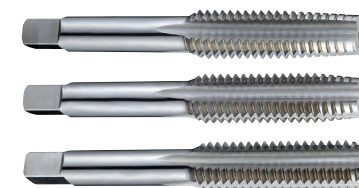
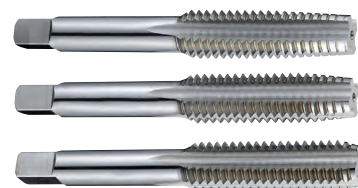
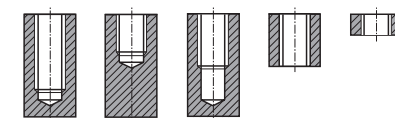
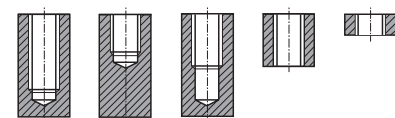

GS
HSS
UNC UNF UNS
USCTI 302
H1-H7
60°
9P/5P/2P
Bright
Steam Oxide
TiN

GS
HSS
UNC UNF UNS
USCTI 302
H1-H7
60°
9P/5P/2P
Bright
Steam Oxide
TiN

		EDP No.						SIZE	Thread Per Inch			Limit	No. of Flute
		Bright		Steam Oxide		TiN			UNC	UNF	UNS		
Taper	Plug	Bottoming	Taper	Plug	Bottoming	Plug	Bottoming						
-	T7A16347H2	T7A16348H2	-	-	-	-	-	10	-	32	-	H2	2
-	T7B16347H2	T7B16348H2	-	-	-	-	-	10	-	32	-	H2	3
T7316346H2	T7316347H2	T7316348H2	T6316346H2	T6316347H2	T6316348H2	-	-	10	-	32	-	H2	4
-	T7A16347	T7A16348	-	-	-	-	-	10	-	32	-	H3	2
-	T7B16347	T7B16348	-	-	-	-	-	10	-	32	-	H3	3
T7316346	T7316347	T7316348	T6316346	T6316347	T6316348	T8316347	T8316348	10	-	32	-	H3	4
-	T7B16347H7	T7B16348H7	-	-	-	-	-	10	-	32	-	H7	3
-	T7316347H7	T7316348H7	-	-	-	-	-	10	-	32	-	H7	4
T7316366	T7316367	T7316368	T6316366	T6316367	T6316368	T8316367	T8316368	12	24	-	-	H3	4
-	T7316387H1	-	-	-	-	-	-	12	-	28	-	H1	4
T7316386	T7316387	T7316388	T6316386	T6316387	T6316388	T8316387	T8316388	12	-	28	-	H3	4
-	T7B16407H1	-	-	-	-	-	-	1/4	20	-	-	H1	3
T7316406H1	T7316407H1	T7316408H1	-	-	-	-	-	1/4	20	-	-	H1	4
-	T7B16407H2	T7B16408H2	-	-	-	-	-	1/4	20	-	-	H2	3
T7316406H2	T7316407H2	T7316408H2	-	-	-	-	-	1/4	20	-	-	H2	4
-	T7A16407	T7A16408	-	-	-	-	-	1/4	20	-	-	H3	2
-	T7B16407	T7B16408	-	-	-	-	-	1/4	20	-	-	H3	3
T7316406	T7316407	T7316408	T6316406	T6316407	T6316408	T8316407	T8316408	1/4	20	-	-	H3	4
-	T7B16407H5	T7B16408H5	-	-	-	-	-	1/4	20	-	-	H5	3
-	T7316407H5	T7316408H5	-	-	-	-	-	1/4	20	-	-	H5	4
-	T7316427H1	T7316428H1	-	-	-	-	-	1/4	-	28	-	H1	4
-	T7316427H2	T7316428H2	-	-	-	-	-	1/4	-	28	-	H2	4
-	T7A16427	T7A16428	-	-	-	-	-	1/4	-	28	-	H3	2
-	T7B16427	T7B16428	-	-	-	-	-	1/4	-	28	-	H3	3
T7316426	T7316427	T7316428	T6316426	T6316427	T6316428	T8316427	T8316428	1/4	-	28	-	H3	4
-	T7316427H4	T7316428H4	-	-	-	-	-	1/4	-	28	-	H4	4
-	T7316447H1	T7316448H1	-	-	-	-	-	5/16	18	-	-	H1	4
T7316446H2	T7316447H2	T7316448H2	T6316446H2	T6316447H2	T6316448H2	-	-	5/16	18	-	-	H2	4
-	T7A16447	T7A16448	-	-	-	-	-	5/16	18	-	-	H3	2

		EDP No.						SIZE	Thread Per Inch			Limit	No. of Flute
		Bright		Steam Oxide		TiN			UNC	UNF	UNS		
Taper	Plug	Bottoming	Taper	Plug	Bottoming	Plug	Bottoming						
-	T7B16447	T7B16448	-	-	-	-	-	5/16	18	-	-	H3	3
T7316446	T7316447	T7316448	T6316446	T6316447	T6316448	T8316447	T8316448	5/16	18	-	-	H3	4
-	T7B16447H5	T7B16448H5	-	-	-	-	-	5/16	18	-	-	H5	3
-	T7316447H5	T7316448H5	-	-	-	-	-	5/16	18	-	-	H5	4
-	T7316467H1	T7316468H1	-	-	-	-	-	5/16	-	24	-	H1	4
-	T7316467H2	T7316468H2	-	-	-	-	-	5/16	-	24	-	H2	4
-	T7B16467	T7B16468	-	-	-	-	-	5/16	-	24	-	H3	3
T7316466	T7316467	T7316468	T6316466	T6316467	T6316468	T8316467	T8316468	5/16	-	24	-	H3	4
-	T7316467H4	T7316468H4	-	-	-	-	-	5/16	-	24	-	H4	4
-	T7B16487H1	T7B16488H1	-	-	-	-	-	3/8	16	-	-	H1	3
-	T7316487H1	T7316488H1	-	-	-	-	-	3/8	16	-	-	H1	4
-	T7316487H2	T7316488H2	-	-	-	-	-	3/8	16	-	-	H2	4
-	T7B16487	T7B16488	-	-	-	-	-	3/8	16	-	-	H3	3
T7316486	T7316487	T7316488	T6316486	T6316487	T6316488	T8316487	T8316488	3/8	16	-	-	H3	4
-	T7B16487H5	T7B16488H5	-	-	-	-	-	3/8	16	-	-	H5	3
-	T7316487H5	T7316488H5	-	-	-	-	-	3/8	16	-	-	H5	4
-	T7316507H1	T7316508H1	-	-	-	-	-	3/8	-	24	-	H1	4
-	T7316507H2	T7316508H2	-	-	-	-	-	3/8	-	24	-	H2	4
-	T7B16507	T7B16508	-	-	-	-	-	3/8	-	24	-	H3	3
T7316506	T7316507	T7316508	T6316506	T6316507	T6316508	T8316507	T8316508	3/8	-	24	-	H3	4
-	T7316507H4	T7316508H4	-	-	-	-	-	3/8	-	24	-	H4	4
-	T7316527H2	-	-	-	-	-	-	7/16	14	-	-	H2	4
-	T7B16527	T7B16528	-	-	-	-	-	7/16	14	-	-	H3	3
T7316526	T7316527	T7316528	T6316526	T6316527	T6316528	T8316527	T8316528	7/16	14	-	-	H3	4
-	T7316527H5	T7316528H5	-	-	-	-	-	7/16	14	-	-	H5	4
-	T7316547H2	-	-	-	-	-	-	7/16	-	20	-	H2	4
-	T7B16547	T7B16548	-	-	-	-	-	7/16	-	20	-	H3	3
T7316546	T7316547	T7316548	T6316546	T6316547	T6316548	T8316547	T8316548	7/16	-	20	-	H3	4
-	T7316547H5	T7316548H5	-	-	-	-	-	7/16	-	20	-	H5	4

▶ For tapping depth on ANSI Length Taps, refer to MCTI 302 on page 201.

▶ For tapping depth on ANSI Length Taps, refer to MCTI 302 on page 201.

▶ NEXT PAGE

▶ NEXT PAGE

◎ : Excellent ○ : Good

◎ : Excellent ○ : Good

Low carbon steels / Free machining carbon steels	Medium to high carbon steels / Low alloyed steels	Steel castings & forgings / Heat-treatable alloy steels	Alloyed tool steels / Mold steels	Free machining stainless steels	Heat-and corrosionresistant stainless steels / Valve stainless steels	Stainless steel castings / Precipitation hardening stainless steels	Pure Aluminum / Aluminum alloys			
◎	◎			◎			◎			
Aluminum alloy castings	Grey cast iron	Nodular cast iron / Chilled cast iron / Meehanite iron / Ductile iron	718 & 625 INCO / Waspaloy / Hastelloy / Invar / Monel / Incoloy	718 Inconel / A286	Titanium	Pure and alloyed copper	Free machining brass / Alloyed brass	Bronze	Zinc	Magnesium
◎						◎	◎		◎	◎

Low carbon steels / Free machining carbon steels	Medium to high carbon steels / Low alloyed steels	Steel castings & forgings / Heat-treatable alloy steels	Alloyed tool steels / Mold steels	Free machining stainless steels	Heat-and corrosionresistant stainless steels / Valve stainless steels	Stainless steel castings / Precipitation hardening stainless steels	Pure Aluminum / Aluminum alloys			
◎	◎			◎			◎			
Aluminum alloy castings	Grey cast iron	Nodular cast iron / Chilled cast iron / Meehanite iron / Ductile iron	718 & 625 INCO / Waspaloy / Hastelloy / Invar / Monel / Incoloy	718 Inconel / A286	Titanium	Pure and alloyed copper	Free machining brass / Alloyed brass	Bronze	Zinc	Magnesium
◎						◎	◎		◎	◎

YG STRAIGHT FLUTE TAPS

T7316/T6316/T8316 SERIES

T7A16/T7B16 SERIES

YG STRAIGHT FLUTE TAPS

T7316/T6316/T8316 SERIES

T7A16/T7B16 SERIES

**HAND TAP
TAPER, PLUG & BOTTOMING STYLE**

**HAND TAP
TAPER, PLUG & BOTTOMING STYLE**

Hole type 2.0xD

Hole type 2.0xD

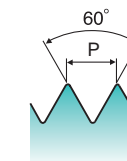
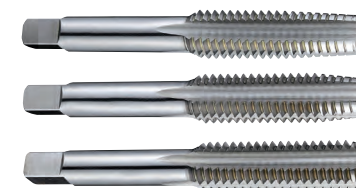
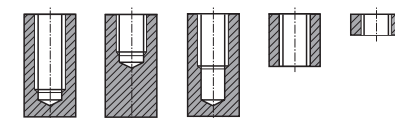
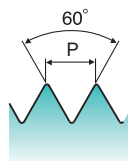
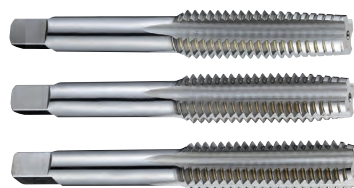
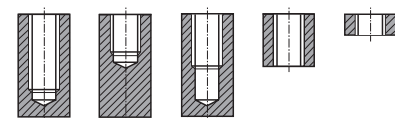

GS HSS UNC UNF UNS USCTI 302 H1-H7 60° 9P/5P/2P Bright Steam Oxide TiN

GS HSS UNC UNF UNS USCTI 302 H1-H7 60° 9P/5P/2P Bright Steam Oxide TiN

		EDP No.						SIZE	Thread Per Inch			Limit	No. of Flute
		Bright		Steam Oxide		TiN			UNC	UNF	UNS		
Taper	Plug	Bottoming	Taper	Plug	Bottoming	Plug	Bottoming						
-	T7316567H1	T7316568H1	-	-	-	-	-	1/2	13	-	-	H1	4
-	T7316567H2	T7316568H2	-	-	-	-	-	1/2	13	-	-	H2	4
-	T7B16567	T7B16568	-	-	-	-	-	1/2	13	-	-	H3	3
T7316566	T7316567	T7316568	T6316566	T6316567	T6316568	T8316567	T8316568	1/2	13	-	-	H3	4
-	T7316567H5	T7316568H5	-	-	-	-	-	1/2	13	-	-	H5	4
-	T7316587H1	T7316588H1	-	-	-	-	-	1/2	-	20	-	H1	4
-	T7B16587	T7B16588	-	-	-	-	-	1/2	-	20	-	H3	3
T7316586	T7316587	T7316588	T6316586	T6316587	T6316588	T8316587	T8316588	1/2	-	20	-	H3	4
-	T7316587H5	T7316588H5	-	-	-	-	-	1/2	-	20	-	H5	4
T7316606	T7316607	T7316608	T6316606	T6316607	T6316608	T8316607	T8316608	9/16	12	-	-	H3	4
-	T7316607H5	T7316608H5	-	-	-	-	-	9/16	12	-	-	H5	4
-	T7316627H2	-	-	-	-	-	-	9/16	-	18	-	H2	4
T7316626	T7316627	T7316628	T6316626	T6316627	T6316628	T8316627	T8316628	9/16	-	18	-	H3	4
-	T7316627H5	T7316628H5	-	-	-	-	-	9/16	-	18	-	H5	4
-	T7316647H1	-	-	-	-	-	-	5/8	11	-	-	H1	4
-	T7316647H2	T7316648H2	-	-	-	-	-	5/8	11	-	-	H2	4
T7316646	T7316647	T7316648	T6316646	T6316647	T6316648	T8316647	T8316648	5/8	11	-	-	H3	4
-	T7316647H5	T7316648H5	-	-	-	-	-	5/8	11	-	-	H5	4
-	T7316667H1	-	-	-	-	-	-	5/8	-	18	-	H1	4
-	T7316667H2	-	-	-	-	-	-	5/8	-	18	-	H2	4
T7316666	T7316667	T7316668	T6316666	T6316667	T6316668	T8316667	T8316668	5/8	-	18	-	H3	4
-	T7316667H5	T7316668H5	-	-	-	-	-	5/8	-	18	-	H5	4
T7316A06	T7316A07	T7316A08	T6316A06	T6316A07	T6316A08	-	-	11/16	-	-	11	H3	4
T7316A26	T7316A27	T7316A28	T6316A26	T6316A27	T6316A28	-	-	11/16	-	-	16	H3	4
-	T7316707H1	T7316708H1	-	-	-	-	-	3/4	10	-	-	H1	4
-	T7316707H2	-	-	-	-	-	-	3/4	10	-	-	H2	4
T7316706	T7316707	T7316708	T6316706	T6316707	T6316708	T8316707	T8316708	3/4	10	-	-	H3	4
-	T7316707H5	T7316708H5	-	-	-	-	-	3/4	10	-	-	H5	4
-	T7316727H1	-	-	-	-	-	-	3/4	-	16	-	H1	4

		EDP No.						SIZE	Thread Per Inch			Limit	No. of Flute
		Bright		Steam Oxide		TiN			UNC	UNF	UNS		
Taper	Plug	Bottoming	Taper	Plug	Bottoming	Plug	Bottoming						
-	T7316727H2	-	-	-	-	-	-	3/4	-	16	-	H2	4
T7316726	T7316727	T7316728	T6316726	T6316727	T6316728	T8316727	T8316728	3/4	-	16	-	H3	4
-	T7316727H5	T7316728H5	-	-	-	-	-	3/4	-	16	-	H5	4
T7316746	T7316747	T7316748	T6316746	T6316747	T6316748	T8316747	T8316748	7/8	9	-	-	H4	4
-	T7316747H6	-	-	-	-	-	-	7/8	9	-	-	H6	4
-	T7316767H2	-	-	-	-	-	-	7/8	-	14	-	H2	4
T7316766	T7316767	T7316768	T6316766	T6316767	T6316768	T8316767	T8316768	7/8	-	14	-	H4	4
-	T7316767H6	-	-	-	-	-	-	7/8	-	14	-	H6	4
-	T7316787H1	T7316788H1	-	-	-	-	-	1	8	-	-	H1	4
-	T7316787H2	-	-	-	-	-	-	1	8	-	-	H2	4
T7316786	T7316787	T7316788	T6316786	T6316787	T6316788	T8316787	T8316788	1	8	-	-	H4	4
-	T7316787H6	-	-	-	-	-	-	1	8	-	-	H6	4
T7316806	T7316807	T7316808	T6316806	T6316807	T6316808	T8316807	T8316808	1	-	12	-	H4	4
-	T7316817H2	-	-	-	-	-	-	1	-	-	14	H2	4
T7316816	T7316817	T7316818	-	-	-	T8316817	T8316818	1	-	-	14	H4	4
T7316826	T7316827	T7316828	-	-	-	T8316827	T8316828	1-1/8	7	-	-	H4	4
T7316846	T7316847	T7316848	-	-	-	T8316847	T8316848	1-1/8	-	12	-	H4	4
T7316866	T7316867	T7316868	-	-	-	T8316867	T8316868	1-1/4	7	-	-	H4	4
T7316886	T7316887	T7316888	-	-	-	T8316887	T8316888	1-1/4	-	12	-	H4	6
T7316906	T7316907	T7316908	-	-	-	T8316907	T8316908	1-3/8	6	-	-	H4	4
T7316926	T7316927	T7316928	-	-	-	T8316927	T8316928	1-3/8	-	12	-	H4	6
T7316946	T7316947	T7316948	-	-	-	T8316947	T8316948	1-1/2	6	-	-	H4	4
T7316966	T7316967	T7316968	-	-	-	T8316967	T8316968	1-1/2	-	12	-	H4	6

▶ For tapping depth on ANSI Length Taps, refer to MCTI 302 on page 201.

▶ For tapping depth on ANSI Length Taps, refer to MCTI 302 on page 201.

▶ NEXT PAGE

◎ : Excellent ○ : Good

◎ : Excellent ○ : Good

Low carbon steels / Free machining carbon steels	Medium to high carbon steels / Low alloyed steels	Steel castings & forgings / Heat-treatable alloy steels	Alloyed tool steels / Mold steels	Free machining stainless steels	Heat-and corrosionresistant stainless steels / Valve stainless steels	Stainless steel castings / Precipitation hardening stainless steels	Pure Aluminum / Aluminum alloys						
◎	◎			◎			◎						◎
Aluminum alloy castings	Grey cast iron	Nodular cast iron / Chilled cast iron / Meehanite iron / Ductile iron	718 & 625 INCO / Waspaloy / Hastelloy / Invar / Monel / Incoloy	718 Inconel / A286	Titanium	Pure and alloyed copper	Free machining brass / Alloyed brass	Bronze	Zinc	Magnesium			
◎						◎	◎		◎	◎			◎

Low carbon steels / Free machining carbon steels	Medium to high carbon steels / Low alloyed steels	Steel castings & forgings / Heat-treatable alloy steels	Alloyed tool steels / Mold steels	Free machining stainless steels	Heat-and corrosionresistant stainless steels / Valve stainless steels	Stainless steel castings / Precipitation hardening stainless steels	Pure Aluminum / Aluminum alloys						
◎	◎			◎			◎						◎
Aluminum alloy castings	Grey cast iron	Nodular cast iron / Chilled cast iron / Meehanite iron / Ductile iron	718 & 625 INCO / Waspaloy / Hastelloy / Invar / Monel / Incoloy	718 Inconel / A286	Titanium	Pure and alloyed copper	Free machining brass / Alloyed brass	Bronze	Zinc	Magnesium			
◎						◎	◎		◎	◎			◎

STRAIGHT FLUTE TAPS

T7315/T6315/T8315 SERIES

STRAIGHT FLUTE TAPS

T7326 SERIES

METRIC HAND TAP TAPER, PLUG & BOTTOMING STYLE

METRIC HAND TAP Oversize Tap

Hole type 2.0xD

Hole type 2.0xD

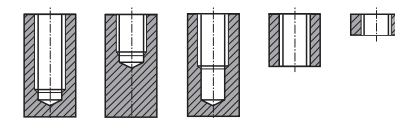
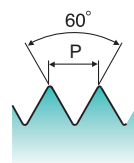
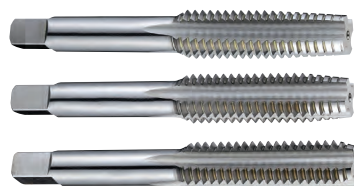
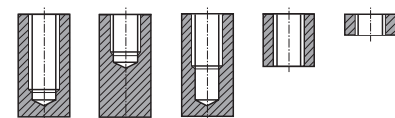

USCTI

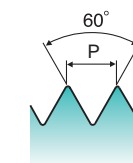

GS HSS M MF USCTI 302 D3-D9 60° 9P/5P/2P Bright Steam Oxide TiN

GS HSS UNC UNF USCTI 302 60° 5P/2P Bright +0.005" oversize

EDP No.								SIZE	Pitch	Limit	No. of Flute
Bright		Steam Oxide			TiN						
Taper	Plug	Bottoming	Taper	Plug	Bottoming	Plug	Bottoming				
-	T7315097	-	-	-	-	-	-	M1.6	0.35	D3	3
-	T7315137	T7315138	-	T6315137	T6315138	T8315137	T8315138	M2	0.40	D3	3
-	T7315177	T7315178	-	T6315177	T6315178	T8315177	T8315178	M2.5	0.45	D3	3
T7315206	T7315207	T7315208	T6315206	T6315207	T6315208	T8315207	T8315208	M3	0.50	D3	3
-	T7315227	T7315228	-	-	-	-	-	M3.5	0.60	D4	3
T7315246	T7315247	T7315248	T6315246	T6315247	T6315248	T8315247	T8315248	M4	0.70	D4	4
-	T7315267	T7315268	-	T6315267	T6315268	T8315267	T8315268	M4.5	0.75	D4	4
T7315286	T7315287	T7315288	T6315286	T6315287	T6315288	T8315287	T8315288	M5	0.80	D4	4
T7315316	T7315317	T7315318	T6315316	T6315317	T6315318	T8315317	T8315318	M6	1.00	D5	4
-	T7315347	T7315348	-	T6315347	T6315348	T8315347	T8315348	M7	1.00	D5	4
T7315366	T7315367	T7315368	T6315366	T6315367	T6315368	T8315367	T8315368	M8	1.25	D5	4
-	T7315377	T7315378	-	T6315377	T6315378	T8315377	T8315378	M8	1.00	D5	4
-	T7315447	T7315448	-	-	-	-	-	M10	1.00	D5	4
T7315426	T7315427	T7315428	T6315426	T6315427	T6315428	T8315427	T8315428	M10	1.50	D6	4
T7315436	T7315437	T7315438	T6315436	T6315437	T6315438	T8315437	T8315438	M10	1.25	D5	4
-	T7315517	T7315518	-	-	-	-	-	M12	1.50	D6	4
T7315506	T7315507	T7315508	T6315506	T6315507	T6315508	T8315507	T8315508	M12	1.75	D6	4
T7315526	T7315527	T7315528	T6315526	T6315527	T6315528	T8315527	T8315528	M12	1.25	D5	4
T7315546	T7315547	T7315548	T6315546	T6315547	T6315548	T8315547	T8315548	M14	2.00	D7	4
-	T7315557	T7315558	-	-	-	-	-	M14	1.50	D6	4
-	T7315567	T7315568	-	-	-	-	-	M14	1.25	D5	4
T7315606	T7315607	T7315608	T6315606	T6315607	T6315608	T8315607	T8315608	M16	2.00	D7	4
T7315616	T7315617	T7315618	T6315616	T6315617	T6315618	T8315617	T8315618	M16	1.50	D6	4
-	T7315657	T7315658	-	-	-	-	-	M18	2.50	D7	4
T7315676	T7315677	T7315678	T6315676	T6315677	T6315678	T8315677	T8315678	M18	1.50	D6	4
T7315706	T7315707	T7315708	T6315706	T6315707	T6315708	T8315707	T8315708	M20	2.50	D7	4
T7315726	T7315727	T7315728	T6315726	T6315727	T6315728	T8315727	T8315728	M20	1.50	D6	4
T7315786	T7315787	T7315788	T6315786	T6315787	T6315788	T8315787	T8315788	M24	3.00	D8	4
T7315946	T7315947	T7315948	T6315946	T6315947	T6315948	-	-	M30	3.50	D9	4
-	T7315B37	T7315B38	-	-	-	-	-	M36	4.00	D9	4

EDP No.		SIZE	Thread Per Inch		No. of Flute
Bright			UNC	UNF	
Plug	Bottoming				
T7326247	-	6	32	-	3
T7326287	-	8	32	-	4
T7326327	-	10	24	-	4
T7326347	-	10	-	32	4
T7326407	T7326408	1/4	20	-	4
T7326427	-	1/4	-	28	4
T7326447	T7326448	5/16	18	-	4
T7326467	-	5/16	-	24	4
T7326487	T7326488	3/8	16	-	4
T7326507	-	3/8	-	24	4
T7326527	-	7/16	14	-	4
T7326567	-	1/2	13	-	4
T7326587	-	1/2	-	20	4
T7326647	-	5/8	11	-	4
T7326707	-	3/4	10	-	4

► For tapping depth on ANSI Length Taps, refer to MCTI 302 on page 201.

► For tapping depth on ANSI Length Taps, refer to MCTI 302 on page 201.

◎ : Excellent ○ : Good

Low carbon steels/ Free machining carbon steels	Medium to high carbon steels/ Low alloyed steels	Steel castings & forgings / Heat-treatable alloy steels	Alloyed tool steels / Mold steels	Free machining stainless steels	Heat-and corrosionresistant stainless steels / Valve stainless steels	Stainless steel castings / Precipitation hardening stainless steels	Pure Aluminum/ Aluminum alloys			
◎	◎			◎			◎			
Aluminum alloy castings	Grey cast iron	Nodular cast iron / Chilled cast iron / Meehanite iron / Ductile iron	718 & 625 INCO / Waspaloy / Hastelloy / Invar / Monel / Incoloy	718 Inconel / A286	Titanium	Pure and alloyed copper	Free machining brass / Alloyed brass	Bronze	Zinc	Magnesium
◎						◎	◎		◎	◎

◎ : Excellent ○ : Good

Low carbon steels/ Free machining carbon steels	Medium to high carbon steels/ Low alloyed steels	Steel castings & forgings / Heat-treatable alloy steels	Alloyed tool steels / Mold steels	Free machining stainless steels	Heat-and corrosionresistant stainless steels / Valve stainless steels	Stainless steel castings / Precipitation hardening stainless steels	Pure Aluminum/ Aluminum alloys			
◎	◎			◎			◎			
Aluminum alloy castings	Grey cast iron	Nodular cast iron / Chilled cast iron / Meehanite iron / Ductile iron	718 & 625 INCO / Waspaloy / Hastelloy / Invar / Monel / Incoloy	718 Inconel / A286	Titanium	Pure and alloyed copper	Free machining brass / Alloyed brass	Bronze	Zinc	Magnesium
◎						◎	◎		◎	◎

STRAIGHT FLUTE TAPS

T7B15 SERIES

METRIC HAND TAP Oversize Tap

Hole type 2.0xD

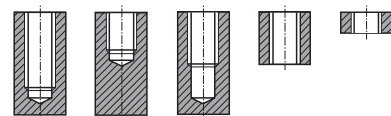

USCTI

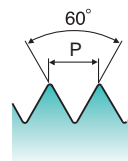

GS HSS M MF USCTI 302 60° 5P/2P Bright +.127mm oversize

EDP No.		SIZE	Pitch	No. of Flute
Bright				
Plug	Bottoming			
T7B15247	T7B15248	M4	0.70	4
T7B15267	T7B15268	M4.5	0.75	4
T7B15287	T7B15288	M5	0.80	4
T7B15317	T7B15318	M6	1.00	4
T7B15347	T7B15348	M7	1.00	4
T7B15367	T7B15368	M8	1.25	4
T7B15377	T7B15378	M8	1.00	4
T7B15427	T7B15428	M10	1.50	4
T7B15437	T7B15438	M10	1.25	4
T7B15507	T7B15508	M12	1.75	4
T7B15527	T7B15528	M12	1.25	4
T7B15607	T7B15608	M16	2.00	4
T7B15707	T7B15708	M20	2.50	4
T7B15787	T7B15788	M24	3.00	4

► For tapping depth on ANSI Length Taps, refer to MCTI 302 on page 201.

◎ : Excellent ○ : Good

Low carbon steels/ Free machining carbon steels	Medium to high carbon steels/ Low alloyed steels	Steel castings & forgings / Heat-treatable alloy steels	Alloyed tool steels / Mold steels	Free machining stainless steels	Heat-and corrosionresistant stainless steels / Valve stainless steels	Stainless steel castings / Precipitation hardening stainless steels	Pure Aluminum/ Aluminum alloys				
◎	◎			◎			◎				
Aluminum alloy castings	Grey cast iron	Nodular cast iron / Chilled cast iron / Meehanite iron / Ductile iron	718 & 625 INCO / Waspaloy / Hastelloy / Invar / Monel / Incoloy	718 Inconel / A286	Titanium	Pure and alloyed copper	Free machining brass / Alloyed brass	Bronze	Zinc	Magnesium	
◎						◎	◎		◎	◎	

STRAIGHT FLUTE TAPS

T7336 SERIES

LEFT HAND TAP

Hole type 2.0xD

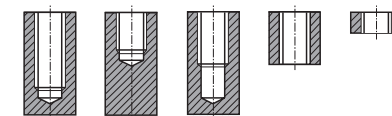

USCTI

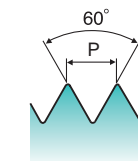

GS HSS UNC UNF USCTI 302 H2-H4 60° 5P/2P Bright

EDP No.		SIZE	Thread Per Inch		Thread Limit	No. of Flute
Bright			UNC	UNF		
Plug	Bottoming					
T7336247	T7336248	6	32	—	H3	3
T7336267	T7336268	6	—	40	H2	3
T7336287	T7336288	8	32	—	H3	4
T7336307	T7336308	8	—	36	H2	4
T7336327	T7336328	10	24	—	H3	4
T7336347	T7336348	10	—	32	H3	4
T7336407	T7336408	1/4	20	—	H3	4
T7336427	T7336428	1/4	—	28	H3	4
T7336447	T7336448	5/16	18	—	H3	4
T7336467	T7336468	5/16	—	24	H3	4
T7336487	T7336488	3/8	16	—	H3	4
T7336507	T7336508	3/8	—	24	H3	4
T7336527	T7336528	7/16	14	—	H3	4
T7336547	T7336548	7/16	—	20	H3	4
T7336567	T7336568	1/2	13	—	H3	4
T7336587	T7336588	1/2	—	20	H3	4
T7336607	T7336608	9/16	12	—	H3	4
T7336627	T7336628	9/16	—	18	H3	4
T7336647	T7336648	5/8	11	—	H3	4
T7336667	T7336668	5/8	—	18	H3	4
T7336707	T7336708	3/4	10	—	H3	4
T7336727	T7336728	3/4	—	16	H3	4
T7336747	T7336748	7/8	9	—	H4	4
T7336767	T7336768	7/8	—	14	H4	4
T7336787	T7336788	1	8	—	H4	4
T7336807	T7336808	1	—	12	H4	4

► For tapping depth on ANSI Length Taps, refer to MCTI 302 on page 201.

◎ : Excellent ○ : Good

Low carbon steels/ Free machining carbon steels	Medium to high carbon steels/ Low alloyed steels	Steel castings & forgings / Heat-treatable alloy steels	Alloyed tool steels / Mold steels	Free machining stainless steels	Heat-and corrosionresistant stainless steels / Valve stainless steels	Stainless steel castings / Precipitation hardening stainless steels	Pure Aluminum/ Aluminum alloys				
◎	◎			◎			◎				
Aluminum alloy castings	Grey cast iron	Nodular cast iron / Chilled cast iron / Meehanite iron / Ductile iron	718 & 625 INCO / Waspaloy / Hastelloy / Invar / Monel / Incoloy	718 Inconel / A286	Titanium	Pure and alloyed copper	Free machining brass / Alloyed brass	Bronze	Zinc	Magnesium	
◎						◎	◎		◎	◎	

YG STRAIGHT FLUTE TAPS

T7A15 SERIES

METRIC LEFT HAND TAP

Hole type 2.0xD

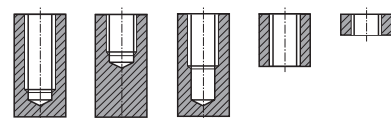

USCTI

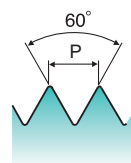

GS HSS UNC UNF USCTI 302 D4-D8 60° 5P/2P Bright

EDP No.		SIZE	Pitch	Limit	No. of Flute
Plug	Bottom				
T7A15227	T7A15228	M3.5	0.6	D4	3
T7A15247	T7A15248	M4	0.7	D4	4
T7A15267	T7A15268	M4.5	0.75	D4	4
T7A15287	T7A15288	M5	0.8	D4	4
T7A15317	T7A15318	M6	1.0	D5	4
T7A15347	T7A15348	M7	1.0	D5	4
T7A15367	T7A15368	M8	1.25	D5	4
T7A15377	T7A15378	M8	1.0	D5	4
T7A15427	T7A15428	M10	1.5	D6	4
T7A15437	T7A15438	M10	1.25	D5	4
T7A15507	T7A15508	M12	1.75	D6	4
T7A15527	T7A15528	M12	1.25	D5	4
T7A15547	T7A15548	M14	2.0	D7	4
T7A15557	T7A15558	M14	1.5	D6	4
T7A15607	T7A15608	M16	2.0	D7	4
T7A15617	T7A15618	M16	1.5	D6	4
T7A15657	T7A15658	M18	2.5	D7	4
T7A15677	T7A15678	M18	1.5	D6	4
T7A15707	T7A15708	M20	2.5	D7	4
T7A15727	T7A15728	M20	1.5	D6	4
T7A15747	T7A15748	M22	2.5	D7	4
T7A15767	T7A15768	M22	1.5	D6	4
T7A15787	T7A15788	M24	3.0	D8	4
T7A15797	T7A15798	M24	2.0	D7	4

► For tapping depth on ANSI Length Taps, refer to MCTI 302 on page 201.

◎ : Excellent ○ : Good

Low carbon steels / Free machining carbon steels	Medium to high carbon steels / Low alloyed steels	Steel castings & forgings / Heat-treatable alloy steels	Alloyed tool steels / Mold steels	Free machining stainless steels	Heat-and corrosionresistant stainless steels / Valve stainless steels	Stainless steel castings / Precipitation hardening stainless steels	Pure Aluminum / Aluminum alloys			
◎	◎			◎			◎			
Aluminum alloy castings	Grey cast iron	Nodular cast iron / Chilled cast iron / Meehanite iron / Ductile iron	718 & 625 INCO / Waspaloy / Hastelloy / Invar / Monel / Incoloy	718 Inconel / A286	Titanium	Pure and alloyed copper	Free machining brass / Alloyed brass	Bronze	Zinc	Magnesium
◎						◎	◎		◎	◎

YG STRAIGHT FLUTE TAPS

T7616/T6616/T8616 SERIES

PULLEY TAPS, 6" EXTENSION PLUG STYLE

Hole type 2.0xD

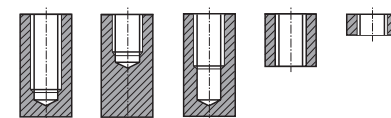

USCTI Long Shank

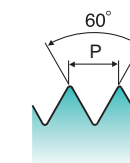

GS HSS UNC UNF USCTI Long Shank H3 60° 4P-5P Bright Steam Oxide TiN

EDP No.			SIZE	UNC	Overall Length	Limit	No. of Flute
Bright	Steam Oxide	TiN					
T7616403	T6616403	T8616403	1/4	20	6	H3	4
T7616443	T6616443	T8616443	5/16	18	6	H3	4
T7616483	T6616483	T8616483	3/8	16	6	H3	4
T7616523	T6616523	T8616523	7/16	14	6	H3	4
T7616563	T6616563	T8616563	1/2	13	6	H3	4
T7616643	T6616643	T8616643	5/8	11	6	H3	4

► For tapping depth on DIN / ANSI Shank Taps, refer to DIN Table on page 199 & 200.

◎ : Excellent ○ : Good

Low carbon steels / Free machining carbon steels	Medium to high carbon steels / Low alloyed steels	Steel castings & forgings / Heat-treatable alloy steels	Alloyed tool steels / Mold steels	Free machining stainless steels	Heat-and corrosionresistant stainless steels / Valve stainless steels	Stainless steel castings / Precipitation hardening stainless steels	Pure Aluminum / Aluminum alloys			
◎	◎			◎			◎			
Aluminum alloy castings	Grey cast iron	Nodular cast iron / Chilled cast iron / Meehanite iron / Ductile iron	718 & 625 INCO / Waspaloy / Hastelloy / Invar / Monel / Incoloy	718 Inconel / A286	Titanium	Pure and alloyed copper	Free machining brass / Alloyed brass	Bronze	Zinc	Magnesium
◎						◎	◎		◎	◎



Being the best through innovation

HSS



FORMING TAPS

- Tapping by Forming Soft Materials (No Chips)



Global Cutting Tool Leader **YG-1**

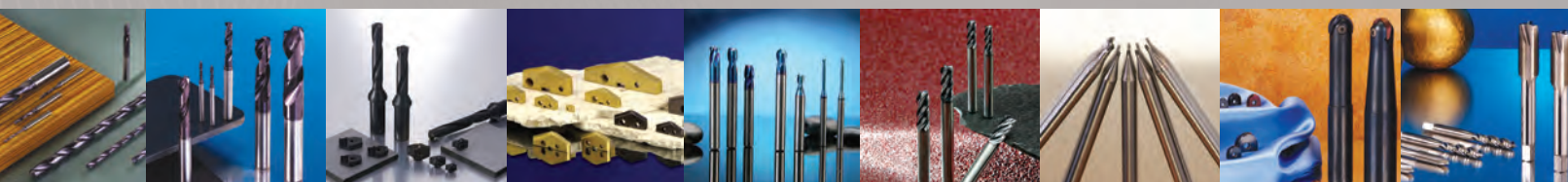







SELECTION GUIDE

FORMING TAPS

Tapping by Forming Soft Materials

INCH

EDP No.	MODEL	Tool Material	Standard	Work Material	Dimensions	Tolerance	Chamfer	Thread Depth	Surface Treatment	Page
TKR03		Super HSS	UNC/UNF	GV	USCTI 302A	H3~H7	2 ~ 3P	3.0D	TiCN	167
ZF		HSSE-V3	UNC/UNF	GV	USCTI 302	H2~H5	1.5 ~ 2P		Bright	168
Z0/Z1/Z2/Z3		HSSE-V3	UNC/UNF	GV	USCTI 302A	H2~H12	4 ~ 5P 1.5 ~ 2P		Bright TiN	169
Z4/Z5/Z6/Z7		HSSE-V3	UNC/UNF	GV	USCTI 302A	H3~H12	4 ~ 5P 1.5 ~ 2P		Bright TiN	171
Z8/ZA/ZC Z9/ZB/ZD		HSSE-V3	M/MF	GV	USCTI 302A	D3~D11	4 ~ 5P 1.5 ~ 2P		Bright TiN / TiCN	173
T7R01/T8R01/ THR01 T7R02/T8R02/ THR02		HSS	UNC/UNF	GV	USCTI 302A	H2~H5	4 ~ 5P 1.5 ~ 2P		Bright TiN / TiCN	174

FORMING TAPS

TKR03 SERIES

FORMING TAPS BOTTOMING STYLE

Hole type 3.0xD

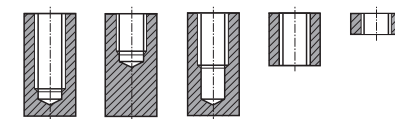

USCTI

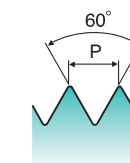

EDP No.				SIZE	Thread Per Inch		No. of Lobe
Class of fit					UNC	UNF	
2B (TiCN)		3B (TiCN)					
TKR03165	H5	TKR03163	H3	4	40	—	4
TKR03205	H5	TKR03203	H3	5	40	—	4
TKR03245	H5	TKR03243	H3	6	32	—	4
TKR03285	H5	TKR03283	H3	8	32	—	4
TKR03326	H6	TKR03324	H4	10	24	—	4
TKR03346	H6	TKR03344	H4	10	—	32	4
TKR03406	H6	TKR03404	H4	1/4	20	—	4
TKR03426	H6	TKR03424	H4	1/4	—	28	4
TKR03447	H7	TKR03445	H5	5/16	18	—	4
TKR03467	H7	TKR03465	H5	5/16	—	24	4
TKR03487	H7	TKR03485	H5	3/8	16	—	4
TKR03507	H7	TKR03505	H5	3/8	—	24	4

► For tapping depth on ANSI Length Taps, refer to MCTI 302 on page 203.

◎ : Excellent ○ : Good

Low carbon steels/ Free machining carbon steels	Medium to high carbon steels/ Low alloyed steels	Steel castings & forgings / Heat-treatable alloy steels	Alloyed tool steels / Mold steels	Free machining stainless steels	Heat-and corrosionresistant stainless steels / Valve stainless steels	Stainless steel castings / Precipitation hardening stainless steels	Pure Aluminum/ Aluminum alloys			
◎	◎			◎			◎			
Aluminum alloy castings	Grey cast iron	Nodular cast iron / Chilled cast iron / Meehanite iron / Ductile iron	718 & 625 INCO / Waspaloy / Hastelloy / Invar / Monel / Incoloy	718 Inconel / A286	Titanium	Pure and alloyed copper	Free machining brass / Alloyed brass	Bronze	Zinc	Magnesium
◎						◎	◎		◎	◎

FORMING TAPS

ZF SERIES

MINIATURE FORMING TAPS BOTTOMING STYLE

Hole type 3.0xD



USCTI

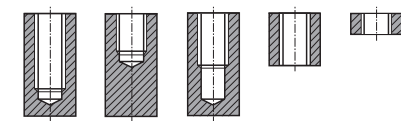
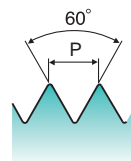

GV HSSE-V3 UNC UNF USCTI 302 H2~H5 60° 1.5P-2P Bottoming Bright

EDP No.	SIZE	Nominal Size (mm)	Pitch		Limit	Overall Length L	Thread Length Lt	Shank Diameter D	Square Length kl	Square Size K	No. of Lobe
			UNC	UNF							
ZFM52	#00	1.1938	90	—	H2	1.63	.25	.1410	.19	.110	4
ZFM53	#00	1.1938	90	—	H3	1.63	.25	.1410	.19	.110	4
ZFM82	#00	1.1938	—	96	H2	1.63	.25	.1410	.19	.110	4
ZFM83	#00	1.1938	—	96	H3	1.63	.25	.1410	.19	.110	4
ZF022	#0	1.524	—	80	H2	1.63	.31	.1410	.19	.110	4
ZF023	#0	1.524	—	80	H3	1.63	.31	.1410	.19	.110	4
ZF024	#0	1.524	—	80	H4	1.63	.31	.1410	.19	.110	4
ZF042	#1	1.854	64	—	H2	1.69	.38	.1410	.19	.110	4
ZF043	#1	1.854	64	—	H3	1.69	.38	.1410	.19	.110	4
ZF044	#1	1.854	64	—	H4	1.69	.38	.1410	.19	.110	4
ZF062	#1	1.854	—	72	H2	1.69	.38	.1410	.19	.110	4
ZF063	#1	1.854	—	72	H3	1.69	.38	.1410	.19	.110	4
ZF064	#1	1.854	—	72	H4	1.69	.38	.1410	.19	.110	4
ZF082	#2	2.1844	56	—	H2	1.75	.44	.1410	.19	.110	4
ZF083	#2	2.1844	56	—	H3	1.75	.44	.1410	.19	.110	4
ZF084	#2	2.1844	56	—	H4	1.75	.44	.1410	.19	.110	4
ZF102	#2	2.1844	—	64	H2	1.75	.44	.1410	.19	.110	4
ZF103	#2	2.1844	—	64	H3	1.75	.44	.1410	.19	.110	4
ZF104	#2	2.1844	—	64	H4	1.75	.44	.1410	.19	.110	4
ZF122	#3	2.5146	48	—	H2	1.81	.50	.1410	.19	.110	4
ZF123	#3	2.5146	48	—	H3	1.81	.50	.1410	.19	.110	4
ZF124	#3	2.5146	48	—	H4	1.81	.50	.1410	.19	.110	4
ZF125	#3	2.5146	48	—	H5	1.81	.50	.1410	.19	.110	4
ZF142	#3	2.5146	—	56	H2	1.81	.50	.1410	.19	.110	4
ZF143	#3	2.5146	—	56	H3	1.81	.50	.1410	.19	.110	4
ZF144	#3	2.5146	—	56	H4	1.81	.50	.1410	.19	.110	4
ZF145	#3	2.5146	—	56	H5	1.81	.50	.1410	.19	.110	4

◎ : Excellent ○ : Good

Low carbon steels / Free machining carbon steels	Medium to high carbon steels / Low alloyed steels	Steel castings & forgings / Heat-treatable alloy steels	Alloyed tool steels / Mold steels	Free machining stainless steels	Heat-and corrosionresistant stainless steels / Valve stainless steels	Stainless steel castings / Precipitation hardening stainless steels	Pure Aluminum / Aluminum alloys			
◎				◎			◎			
Aluminum alloy castings	Grey cast iron	Nodular cast iron / Chilled cast iron / Meehanite iron / Ductile iron	718 & 625 INCO / Waspaloy / Hastelloy / Invar / Monel / Incoloy	718 Inconel / A286	Titanium	Pure and alloyed copper	Free machining brass / Alloyed brass	Bronze	Zinc	Magnesium
◎									◎	◎

FORMING TAPS

Z0/Z1/Z2/Z3 SERIES

FORMING TAPS PLUG & BOTTOMING STYLE

A variety of H Limit

Hole type 3.0xD



USCTI

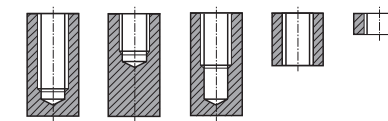
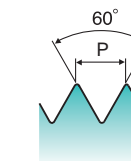

GV HSSE-V3 UNC UNF USCTI 302A H2~H12 60° 4P-5P Plug 1.5P-2P Bottoming Bright TiN

EDP No.				SIZE	Thread Per Inch		Limit	No. of Lobe
Plug		Bottom			UNC	UNF		
Bright	TiN	Bright	TiN					
—	—	Z2022	Z3022	0	—	80	H2	4
—	—	Z2023	Z3023	0	—	80	H3	4
—	—	Z2042	Z3042	1	64	—	H2	4
—	—	Z2062	Z3062	1	—	72	H2	4
—	—	Z2063	Z3063	1	—	72	H3	4
—	—	Z2082	Z3082	2	56	—	H2	4
—	—	Z2083	Z3083	2	56	—	H3	4
—	—	Z2102	Z3102	2	—	64	H2	4
—	—	Z2122	Z3122	3	48	—	H2	4
—	—	Z2123	Z3123	3	48	—	H3	4
—	—	Z2143	Z3143	3	—	56	H3	4
Z0163	Z1163	Z2163	Z3163	4	40	—	H3	4
Z0165	Z1165	Z2165	Z3165	4	40	—	H5	4
Z0183	Z1183	Z2183	Z3183	4	—	48	H3	4
Z0185	Z1185	Z2185	Z3185	4	—	48	H5	4
Z0203	Z1203	Z2203	Z3203	5	40	—	H3	4
Z0205	Z1205	Z2205	Z3205	5	40	—	H5	4
Z0225	Z1225	Z2225	Z3225	5	—	44	H5	4
Z0243	Z1243	Z2243	Z3243	6	32	—	H3	4
Z0245	Z1245	Z2245	Z3245	6	32	—	H5	4
Z0263	Z1263	Z2263	Z3263	6	—	40	H3	4
Z0265	Z1265	Z2265	Z3265	6	—	40	H5	4
Z0283	Z1283	Z2283	Z3283	8	32	—	H3	4
Z0285	Z1285	Z2285	Z3285	8	32	—	H5	4
Z0303	Z1303	Z2303	Z3303	8	—	36	H3	4
Z0305	Z1305	Z2305	Z3305	8	—	36	H5	4
Z0324	Z1324	Z2324	Z3324	10	24	—	H4	4
Z0326	Z1326	Z2326	Z3326	10	24	—	H6	4
Z0344	Z1344	Z2344	Z3344	10	—	32	H4	4
Z0346	Z1346	Z2346	Z3346	10	—	32	H6	4
Z0364	Z1364	Z2364	Z3364	12	24	—	H4	4
Z0366	Z1366	Z2366	Z3366	12	24	—	H6	4

► For tapping depth on ANSI Length Taps, refer to MCTI 302 on page 203.
 ► Hardslick coating is available on your request (Bright Finish EDP No + H)

◎ : Excellent ○ : Good

Low carbon steels / Free machining carbon steels	Medium to high carbon steels / Low alloyed steels	Steel castings & forgings / Heat-treatable alloy steels	Alloyed tool steels / Mold steels	Free machining stainless steels	Heat-and corrosionresistant stainless steels / Valve stainless steels	Stainless steel castings / Precipitation hardening stainless steels	Pure Aluminum / Aluminum alloys			
◎	◎			◎			◎			
Aluminum alloy castings	Grey cast iron	Nodular cast iron / Chilled cast iron / Meehanite iron / Ductile iron	718 & 625 INCO / Waspaloy / Hastelloy / Invar / Monel / Incoloy	718 Inconel / A286	Titanium	Pure and alloyed copper	Free machining brass / Alloyed brass	Bronze	Zinc	Magnesium
◎							◎	◎	◎	◎

FORMING TAPS

Z0/Z1/Z2/Z3 SERIES

FORMING TAPS PLUG & BOTTOMING STYLE

Hole type 3.0xD



USCTI

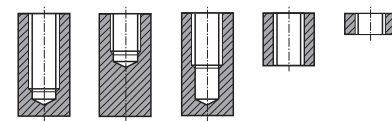
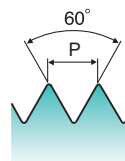

GV HSSE-V3 UNC UNF USCTI 302A H2-H12 60° 4P~5P Plug 1.5P~2P Bottoming Bright TiN

	EDP No.				SIZE	Thread Per Inch		Limit	No. of Lobe
	Plug		Bottom			UNC	UNF		
	Bright	TiN	Bright	TiN					
Z0404	Z1404	Z2404	Z3404	1/4	20	—	H4	4	
Z0406	Z1406	Z2406	Z3406	1/4	20	—	H6	4	
Z0424	Z1424	Z2424	Z3424	1/4	—	28	H4	4	
Z0426	Z1426	Z2426	Z3426	1/4	—	28	H6	4	
Z0445	Z1445	Z2445	Z3445	5/16	18	—	H5	4	
Z0447	Z1447	Z2447	Z3447	5/16	18	—	H7	4	
Z0465	Z1465	Z2465	Z3465	5/16	—	24	H5	4	
Z0467	Z1467	Z2467	Z3467	5/16	—	24	H7	4	
Z0485	Z1485	Z2485	Z3485	3/8	16	—	H5	4	
Z0487	Z1487	Z2487	Z3487	3/8	16	—	H7	4	
Z0505	Z1505	Z2505	Z3505	3/8	—	24	H5	4	
Z0507	Z1507	Z2507	Z3507	3/8	—	24	H7	4	
Z0528	Z1528	Z2528	Z3528	7/16	14	—	H8	4	
Z0548	Z1548	Z2548	Z3548	7/16	—	20	H8	4	
Z0568	Z1568	Z2568	Z3568	1/2	13	—	H8	4	
Z0565	Z1565	Z2565	Z3565	1/2	13	—	H5	4	
Z0585	Z1585	Z2585	Z3585	1/2	—	20	H5	4	
Z0588	Z1588	Z2588	Z3588	1/2	—	20	H8	4	
Z0607	Z1607	Z2607	Z3607	9/16	12	—	H7	4	
Z0600	Z1600	Z2600	Z3600	9/16	12	—	H10	4	
Z0628	Z1628	Z2628	Z3628	9/16	—	18	H8	4	
Z0620	Z1620	Z2620	Z3620	9/16	—	18	H10	4	
Z0648	Z1648	Z2648	Z3648	5/8	11	—	H8	4	
Z0640	Z1640	Z2640	Z3640	5/8	11	—	H10	4	
Z0660	Z1660	Z2660	Z3660	5/8	—	18	H10	4	
Z0700	Z1700	Z2700	Z3700	3/4	10	—	H10	4	
Z070B	Z170B	Z270B	Z370B	3/4	10	—	H12	4	
Z0728	Z1728	Z2728	Z3728	3/4	—	16	H8	4	
Z0720	Z1720	Z2720	Z3720	3/4	—	16	H10	4	

► For tapping depth on ANSI Length Taps, refer to MCTI 302 on page 203.
 ► Hardslick coating is available on your request (Bright Finish EDP No + H)

◎ : Excellent ○ : Good

Low carbon steels / Free machining carbon steels	Medium to high carbon steels / Low alloyed steels	Steel castings & forgings / Heat-treatable alloy steels	Alloyed tool steels / Mold steels	Free machining stainless steels	Heat-and corrosionresistant stainless steels / Valve stainless steels	Stainless steel castings / Precipitation hardening stainless steels	Pure Aluminum / Aluminum alloys			
◎	◎			◎			◎			
Aluminum alloy castings	Grey cast iron	Nodular cast iron / Chilled cast iron / Meehanite iron / Ductile iron	718 & 625 INCO / Waspaloy / Hastelloy / Invar / Monel / Incoloy	718 Inconel / A286	Titanium	Pure and alloyed copper	Free machining brass / Alloyed brass	Bronze	Zinc	Magnesium
◎						◎	◎		◎	◎

FORMING TAPS

Z4/Z5/Z6/Z7 SERIES

FORMING TAPS WITH OIL GROOVE PLUG & BOTTOMING STYLE

Hole type 3.0xD



USCTI

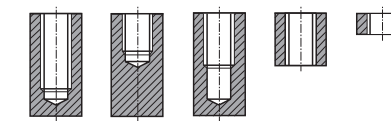
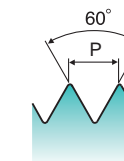

GV HSSE-V3 UNC UNF USCTI 302A H3-H12 60° 4P~5P Plug 1.5P~2P Bottoming Bright TiN

	EDP No.				SIZE	Thread Per Inch		Limit	No. of Lobe
	Plug		Bottom			UNC	UNF		
	Bright	TiN	Bright	TiN					
Z4163	Z5163	Z6163	Z7163	4	40	—	H3	4	
Z4165	Z5165	Z6165	Z7165	4	40	—	H5	4	
Z4183	Z5183	Z6183	Z7183	4	—	48	H3	4	
Z4185	Z5185	Z6185	Z7185	4	—	48	H5	4	
Z4203	Z5203	Z6203	Z7203	5	40	—	H3	4	
Z4205	Z5205	Z6205	Z7205	5	40	—	H5	4	
Z4225	Z5225	Z6225	Z7225	5	—	44	H5	4	
Z4243	Z5243	Z6243	Z7243	6	32	—	H3	4	
Z4245	Z5245	Z6245	Z7245	6	32	—	H5	4	
Z4263	Z5263	Z6263	Z7263	6	—	40	H3	4	
Z4265	Z5265	Z6265	Z7265	6	—	40	H5	4	
Z4283	Z5283	Z6283	Z7283	8	32	—	H3	4	
Z4285	Z5285	Z6285	Z7285	8	32	—	H5	4	
Z4303	Z5303	Z6303	Z7303	8	—	36	H3	4	
Z4305	Z5305	Z6305	Z7305	8	—	36	H5	4	
Z4324	Z5324	Z6324	Z7324	10	24	—	H4	4	
Z4326	Z5326	Z6326	Z7326	10	24	—	H6	4	
Z4344	Z5344	Z6344	Z7344	10	—	32	H4	4	
Z4346	Z5346	Z6346	Z7346	10	—	32	H6	4	
Z4364	Z5364	Z6364	Z7364	12	24	—	H4	4	
Z4366	Z5366	Z6366	Z7366	12	24	—	H6	4	
Z4404	Z5404	Z6404	Z7404	1/4	20	—	H4	4	
Z4406	Z5406	Z6406	Z7406	1/4	20	—	H6	4	
Z4424	Z5424	Z6424	Z7424	1/4	—	28	H4	4	
Z4426	Z5426	Z6426	Z7426	1/4	—	28	H6	4	
Z4445	Z5445	Z6445	Z7445	5/16	18	—	H5	4	
Z4447	Z5447	Z6447	Z7447	5/16	18	—	H7	4	
Z4465	Z5465	Z6465	Z7465	5/16	—	24	H5	4	
Z4467	Z5467	Z6467	Z7467	5/16	—	24	H7	4	
Z4485	Z5485	Z6485	Z7485	3/8	16	—	H5	4	

► For tapping depth on ANSI Length Taps, refer to MCTI 302 on page 203.
 ► Hardslick coating is available on your request (Bright Finish EDP No + H)

► NEXT PAGE

◎ : Excellent ○ : Good

Low carbon steels / Free machining carbon steels	Medium to high carbon steels / Low alloyed steels	Steel castings & forgings / Heat-treatable alloy steels	Alloyed tool steels / Mold steels	Free machining stainless steels	Heat-and corrosionresistant stainless steels / Valve stainless steels	Stainless steel castings / Precipitation hardening stainless steels	Pure Aluminum / Aluminum alloys			
◎	◎			◎			◎			
Aluminum alloy castings	Grey cast iron	Nodular cast iron / Chilled cast iron / Meehanite iron / Ductile iron	718 & 625 INCO / Waspaloy / Hastelloy / Invar / Monel / Incoloy	718 Inconel / A286	Titanium	Pure and alloyed copper	Free machining brass / Alloyed brass	Bronze	Zinc	Magnesium
◎						◎	◎		◎	◎

FORMING TAPS

Z4/Z5/Z6/Z7 SERIES

FORMING TAPS

Z8/ZA/ZC SERIES
Z9/ZB/ZD SERIES

FORMING TAPS WITH OIL GROOVE PLUG & BOTTOMING STYLE for General Purpose

FORMING TAPS WITH OIL GROOVE PLUG & BOTTOMING STYLE for General Purpose

Hole type 3.0xD

Hole type 3.0xD

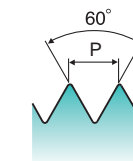
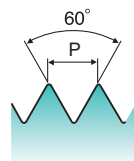
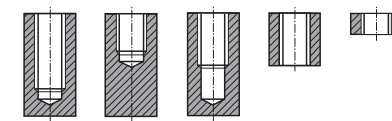
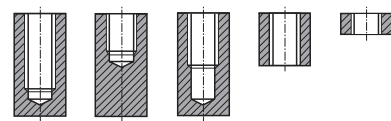

GV HSSE-V3 UNC UNF USCTI 302A H3-H12 60° 4P~5P Plug 1.5P~2P Bottoming Bright TiN

GV HSSE-V3 M MF USCTI 302A D3~D11 60° 4P~5P Plug 1.5P~2P Bottoming Bright TiN TiCN

	EDP No.				SIZE	Thread Per Inch		Limit	No. of Lobe
	Plug		Bottom			UNC	UNF		
	Bright	TiN	Bright	TiN					
Z4487	Z5487	Z6487	Z7487	3/8	16	—	H7	4	
Z4505	Z5505	Z6505	Z7505	3/8	—	24	H5	4	
Z4507	Z5507	Z6507	Z7507	3/8	—	24	H7	4	
Z4528	Z5528	Z6528	Z7528	7/16	14	—	H8	4	
Z4548	Z5548	Z6548	Z7548	7/16	—	20	H8	4	
Z4568	Z5568	Z6568	Z7568	1/2	13	—	H8	4	
Z4565	Z5565	Z6565	Z7565	1/2	13	—	H5	4	
Z4585	Z5585	Z6585	Z7585	1/2	—	20	H5	4	
Z4588	Z5588	Z6588	Z7588	1/2	—	20	H8	4	
Z4607	Z5607	Z6607	Z7607	9/16	12	—	H7	4	
Z4600	Z5600	Z6600	Z7600	9/16	12	—	H10	4	
Z4628	Z5628	Z6628	Z7628	9/16	—	18	H8	4	
Z4620	Z5620	Z6620	Z7620	9/16	—	18	H10	4	
Z4648	Z5648	Z6648	Z7648	5/8	11	—	H8	4	
Z4640	Z5640	Z6640	Z7640	5/8	11	—	H10	4	
Z4660	Z5660	Z6660	Z7660	5/8	—	18	H10	4	
Z4700	Z5700	Z6700	Z7700	3/4	10	—	H10	4	
Z470B	Z570B	Z670B	Z770B	3/4	10	—	H12	4	
Z4728	Z5728	Z6728	Z7728	3/4	—	16	H8	4	
Z4720	Z5720	Z6720	Z7720	3/4	—	16	H10	4	

	EDP No.						SIZE	Pitch	Limit	No. of Lobe
	Plug			Bottom						
	Bright	TiN	TiCN	Bright	TiN	TiCN				
-	-	-	Z9133	ZB133	ZD133	M2	0.4	D3	4	
Z8205	ZA205	ZC205	Z9205	ZB205	ZD205	M3	0.5	D5	4	
Z8246	ZA246	ZC246	Z9246	ZB246	ZD246	M4	0.7	D6	4	
Z8287	ZA287	ZC287	Z9287	ZB287	ZD287	M5	0.8	D7	4	
Z8318	ZA318	ZC318	Z9318	ZB318	ZD318	M6	1.0	D8	4	
Z8369	ZA369	ZC369	Z9369	ZB369	ZD369	M8	1.25	D9	4	
Z8420	ZA420	ZC420	Z9420	ZB420	ZD420	M10	1.5	D10	4	
Z850A	ZA50A	ZC50A	Z950A	ZB50A	ZD50A	M12	1.75	D11	4	

► For tapping depth on ANSI Length Taps, refer to MCTI 302 on page 203.
► Hardslick coating is available on your request (Bright Finish EDP No + H)

► For tapping depth on ANSI Length Taps, refer to MCTI 302 on page 203.
► Hardslick coating is available on your request (Bright Finish EDP No + H)

◎ : Excellent ○ : Good

◎ : Excellent ○ : Good

Low carbon steels/ Free machining carbon steels	Medium to high carbon steels/ Low alloyed steels	Steel castings & forgings / Heat-treatable alloy steels	Alloyed tool steels / Mold steels	Free machining stainless steels	Heat-and corrosionresistant stainless steels / Valve stainless steels	Stainless steel castings / Precipitation hardening stainless steels	Pure Aluminum/ Aluminum alloys				
◎	◎			◎			◎				
Aluminum alloy castings	Grey cast iron	Nodular cast iron / Chilled cast iron / Meehanite iron / Ductile iron	718 & 625 INCO / Waspaloy / Hastelloy / Invar / Monel / Incoloy	718 Inconel / A286	Titanium	Pure and alloyed copper	Free machining brass / Alloyed brass	Bronze	Zinc	Magnesium	
◎						◎	◎		◎	◎	

Low carbon steels/ Free machining carbon steels	Medium to high carbon steels/ Low alloyed steels	Steel castings & forgings / Heat-treatable alloy steels	Alloyed tool steels / Mold steels	Free machining stainless steels	Heat-and corrosionresistant stainless steels / Valve stainless steels	Stainless steel castings / Precipitation hardening stainless steels	Pure Aluminum/ Aluminum alloys				
◎	◎			◎			◎				
Aluminum alloy castings	Grey cast iron	Nodular cast iron / Chilled cast iron / Meehanite iron / Ductile iron	718 & 625 INCO / Waspaloy / Hastelloy / Invar / Monel / Incoloy	718 Inconel / A286	Titanium	Pure and alloyed copper	Free machining brass / Alloyed brass	Bronze	Zinc	Magnesium	
◎						◎	◎		◎	◎	

HSS

CARBIDE

Y/G FORMING TAPS

T7R01/T8R01/THR01 SERIES

T7R02/T8R02/THR02 SERIES

FORMING TAPS PLUG & BOTTOMING STYLE

Hole type 3.0xD

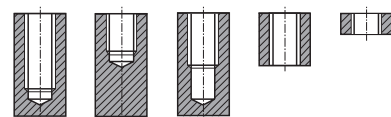

USCTI

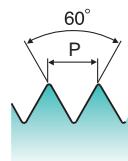

GV HSS UNC UNF USCTI 302A H2-H5 60° 4P~5P Plug 1.5P~2P Bottoming Bright TiN TiCN

FORMING TAPS	EDP No.						SIZE	Thread Per Inch		Limit
	Plug			Bottom				UNC	UNF	
	Bright	TiN	TiCN	Bright	TiN	TiCN				
—	—	—	T7R02022	T8R02022	THR02022	0	—	80	H2	
—	—	—	T7R02082	T8R02082	THR02082	2	56	—	H2	
—	—	—	T7R02123	T8R02123	THR02123	3	48	—	H3	
T7R01163	T8R01163	THR01163	T7R02163	T8R02163	THR02163	4	40	—	H3	
T7R01203	T8R01203	THR01203	T7R02203	T8R02203	THR02203	5	40	—	H3	
T7R01243	T8R01243	THR01243	T7R02243	T8R02243	THR02243	6	32	—	H3	
T7R01283	T8R01283	THR01283	T7R02283	T8R02283	THR02283	8	32	—	H3	
T7R01324	T8R01324	THR01324	T7R02324	T8R02324	THR02324	10	24	—	H4	
T7R01344	T8R01344	THR01344	T7R02344	T8R02344	THR02344	10	—	32	H4	
T7R01404	T8R01404	THR01404	T7R02404	T8R02404	THR02404	1/4	20	—	H4	
T7R01424	T8R01424	THR01424	T7R02424	T8R02424	THR02424	1/4	—	28	H4	
T7R01445	T8R01445	THR01445	T7R02445	T8R02445	THR02445	5/16	18	—	H5	
T7R01485	T8R01485	THR01485	T7R02485	T8R02485	THR02485	3/8	16	—	H5	

► For tapping depth on ANSI Length Taps, refer to MCTI 302 on page 203.

◎ : Excellent ○ : Good

Low carbon steels / Free machining carbon steels	Medium to high carbon steels / Low alloyed steels	Steel castings & forgings / Heat-treatable alloy steels	Alloyed tool steels / Mold steels	Free machining stainless steels	Heat-and corrosionresistant stainless steels / Valve stainless steels	Stainless steel castings / Precipitation hardening stainless steels	Pure Aluminum / Aluminum alloys				
◎	◎			○			◎				
Aluminum alloy castings	Grey cast iron	Nodular cast iron / Chilled cast iron / Meehanite iron / Ductile iron	718 & 625 INCO / Waspaloy / Hastelloy / Invar / Monel / Incoloy	718 Inconel / A286	Titanium	Pure and alloyed copper	Free machining brass / Alloyed brass	Bronze	Zinc	Magnesium	
◎						○	○		○	○	



Being the best through innovation

HSS



SCREW THREAD INSERT TAPS

SELECTION GUIDE

SCREW THREAD INSERT TAPS

INCH

EDP No.	MODEL	Tool Material	Standard	Work Material	Dimensions	Tolerance	Chamfer	Thread Depth	Surface Treatment	Page
ST/SI		HSSE-V3	UNC/UNF	GS	USCTI 322	2B	1.5 ~ 2P	2.5D	Hardslick	177
T7406		HSS	UNC/UNF	GS	USCTI 322	H2~H4	1.5 ~ 2P		Bright	178
T7425		HSS	M/MF	GS	USCTI 322A	D2~D4	1.5 ~ 2P		Bright	179
ST/SI		HSSE-V3	UNC/UNF	GS	USCTI 322	2B	4 ~ 5P	3.0D	Hardslick	180
T7436		HSS	UNC/UNF	GS	USCTI 322	H1~H4	4 ~ 5P		Bright	181
T7415		HSS	M/MF	GS	USCTI 322A	D2~D4	4 ~ 5P		Bright	182
T7426		HSS	UNC/UNF	GS	USCTI 322	H1~H4	4 ~ 5P 1.5 ~ 2P	2.0D	Bright	183
T7405		HSS	M/MF	GS	USCTI 322A	D2~D4	4 ~ 5P 1.5 ~ 2P		Bright	184

SCREW THREAD INSERT TAPS

ST/SI SERIES

SPIRAL FLUTE TAPS SCREW THREAD INSERT for General Purpose

Hole type 2.5xD

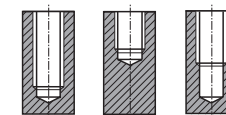

USCTI

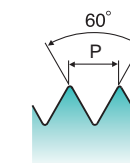

GS
HSSE-V3
UNC UNF
USCTI 322
2B
60°
1.5P~2P
Hardslick
R40

EDP No.	SIZE	Thread Per Inch		Limit	No. of Flute
		UNC	UNF		
ST162	#4	40	—	2B	3
SI182	#4	—	48	2B	3
ST202	#5	40	—	2B	3
SI222	#5	—	44	2B	3
ST242	#6	32	—	2B	3
SI262	#6	—	40	2B	3
ST282	#8	32	—	2B	3
SI302	#8	—	36	2B	3
ST322	#10	24	—	2B	3
SI342	#10	—	32	2B	3
ST362	#12	24	—	2B	3
SI382	#12	—	28	2B	3
ST402	1/4	20	—	2B	3
SI422	1/4	—	28	2B	3
ST442	5/16	18	—	2B	3
SI462	5/16	—	24	2B	3
ST482	3/8	16	—	2B	3
SI502	3/8	—	24	2B	3
ST522	7/16	14	—	2B	3
SI542	7/16	—	20	2B	3
ST562	1/2	13	—	2B	3
SI582	1/2	—	20	2B	3
ST602	9/16	12	—	2B	4
SI622	9/16	—	18	2B	4
ST642	5/8	11	—	2B	4
SI662	5/8	—	18	2B	4
ST702	3/4	10	—	2B	4
SI722	3/4	—	16	2B	4

► For tapping depth on ANSI Length Taps, refer to MCTI 302 on page 205.

◎ : Excellent ○ : Good

Low carbon steels/ Free machining carbon steels	Medium to high carbon steels/ Low alloyed steels	Steel castings & forgings / Heat-treatable alloy steels	Alloyed tool steels / Mold steels	Free machining stainless steels	Heat-and corrosionresistant stainless steels / Valve stainless steels	Stainless steel castings / Precipitation hardening stainless steels	Pure Aluminum/ Aluminum alloys			
◎	◎	○					○			
Aluminum alloy castings	Grey cast iron	Nodular cast iron / Chilled cast iron / Meehanite iron / Ductile iron	718 & 625 INCO / Waspaloy / Hastelloy / Invar / Monel / Incoloy	718 Inconel / A286	Titanium	Pure and alloyed copper	Free machining brass / Alloyed brass	Bronze	Zinc	Magnesium
○	○									

YG SCREW THREAD INSERT TAPS

T7406 SERIES

SPIRAL FLUTE TAPS SCREW THREAD INSERT for General Purpose

Hole type 2.5xD

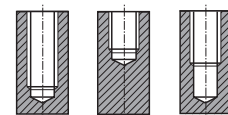

USCTI

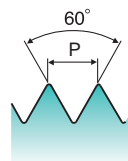

GS
HSS
UNC UNF
USCTI 322
H2-H4
60°
1.5P~2P
Bright
R50

EDP No.	Bright	SIZE	Thread Per Inch		Limit	No. of Flute
			UNC	UNF		
T7406082		2	56	—	H2	2
T7406122		3	48	—	H2	2
T7406162		4	40	—	H2	2
T7406182		4	—	48	H2	3
T7406242		6	32	—	H2	3
T7406243		6	32	—	H3	3
T7406262		6	—	40	H2	3
T7406282		8	32	—	H2	3
T7406283		8	32	—	H3	3
T7406302		8	—	36	H2	3
T7406322		10	24	—	H2	3
T7406323		10	24	—	H3	3
T7406342		10	—	32	H2	3
T7406343		10	—	32	H3	3
T7406402		1/4	20	—	H2	3
T7406403		1/4	20	—	H3	3
T7406422		1/4	—	28	H2	3
T7406423		1/4	—	28	H3	3
T7406443		5/16	18	—	H3	3
T7406444		5/16	18	—	H4	3
T7406462		5/16	—	24	H2	3
T7406463		5/16	—	24	H3	3
T7406483		3/8	16	—	H3	3
T7406484		3/8	16	—	H4	3
T7406502		3/8	—	24	H2	3
T7406503		3/8	—	24	H3	3
T7406523		7/16	14	—	H3	4
T7406524		7/16	14	—	H4	4
T7406543		7/16	—	20	H3	3
T7406544		7/16	—	20	H4	3
T7406563		1/2	13	—	H3	4
T7406564		1/2	13	—	H4	4
T7406583		1/2	—	20	H3	4
T7406584		1/2	—	20	H4	4

► For tapping depth on ANSI Length Taps, refer to MCTI 302 on page 205.

◎ : Excellent ○ : Good

Low carbon steels / Free machining carbon steels	Medium to high carbon steels / Low alloyed steels	Steel castings & forgings / Heat-treatable alloy steels	Alloyed tool steels / Mold steels	Free machining stainless steels	Heat-and corrosionresistant stainless steels / Valve stainless steels	Stainless steel castings / Precipitation hardening stainless steels	Pure Aluminum / Aluminum alloys													
○	○						○													
Aluminum alloy castings	Grey cast iron	Nodular cast iron / Chilled cast iron / Meehanite iron / Ductile iron	718 & 625 INCO / Waspaloy / Hastelloy / Invar / Monel / Incoloy	718 Inconel / A286	Titanium	Pure and alloyed copper	Free machining brass / Alloyed brass	Bronze	Zinc	Magnesium										
○	○																			

YG SCREW THREAD INSERT TAPS

T7425 SERIES

METRIC SPIRAL FLUTE TAPS SCREW THREAD INSERT for General Purpose

Hole type 2.5xD

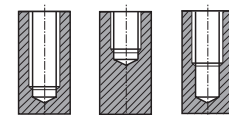

USCTI

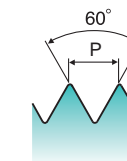

GS
HSS
M MF
USCTI 322A
D2-D4
60°
1.5P~2P
Bright
R50

EDP No.	Bright	SIZE	Pitch	Limit	No. of Flute
T7425132		M2	0.40	D2	2
T7425172		M2.5	0.45	D2	2
T7425202		M3	0.50	D2	3
T7425243		M4	0.70	D3	3
T7425283		M5	0.80	D3	3
T7425313		M6	1.00	D3	3
T7425363		M8	1.25	D3	3
T7425424		M10	1.50	D4	3
T7425504		M12	1.75	D4	3

► For tapping depth on ANSI Length Taps, refer to MCTI 302 on page 205.

◎ : Excellent ○ : Good

Low carbon steels / Free machining carbon steels	Medium to high carbon steels / Low alloyed steels	Steel castings & forgings / Heat-treatable alloy steels	Alloyed tool steels / Mold steels	Free machining stainless steels	Heat-and corrosionresistant stainless steels / Valve stainless steels	Stainless steel castings / Precipitation hardening stainless steels	Pure Aluminum / Aluminum alloys													
○	○						○													
Aluminum alloy castings	Grey cast iron	Nodular cast iron / Chilled cast iron / Meehanite iron / Ductile iron	718 & 625 INCO / Waspaloy / Hastelloy / Invar / Monel / Incoloy	718 Inconel / A286	Titanium	Pure and alloyed copper	Free machining brass / Alloyed brass	Bronze	Zinc	Magnesium										
○	○																			

YG SCREW THREAD INSERT TAPS

ST/SI SERIES

YG SCREW THREAD INSERT TAPS

T7436 SERIES

SPIRAL POINT TAPS SCREW THREAD INSERT for General Purpose

SPIRAL POINT TAPS SCREW THREAD INSERT for General Purpose

Hole type 3.0xD

Hole type 3.0xD



USCTI

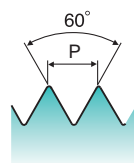

USCTI

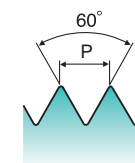

GS
HSSE-V3
UNC UNF
USCTI 322
2B
60°
4P~5P
Hardslick

GS
HSS
UNC UNF
USCTI 322
H1~H4
60°
4P~5P
Bright

EDP No.	SIZE	Thread Per Inch		Limit	No. of Flute
		UNC	UNF		
SI162	#4	40	—	2B	3
ST182	#4	—	48	2B	3
SI242	#6	32	—	2B	3
ST262	#6	—	40	2B	3
SI282	#8	32	—	2B	3
ST302	#8	—	36	2B	3
SI322	#10	24	—	2B	3
ST342	#10	—	32	2B	3
SI402	1/4	20	—	2B	3
ST422	1/4	—	28	2B	3
SI442	5/16	18	—	2B	3
ST462	5/16	—	24	2B	3
SI482	3/8	16	—	2B	3
ST502	3/8	—	24	2B	3
SI522	7/16	14	—	2B	3
ST542	7/16	—	20	2B	3
SI562	1/2	13	—	2B	3
ST582	1/2	—	20	2B	3
SI602	9/16	12	—	2B	3
ST622	9/16	—	18	2B	3
SI642	5/8	11	—	2B	3
ST662	5/8	—	18	2B	3
SI702	3/4	10	—	2B	3
ST722	3/4	—	16	2B	3

► For tapping depth on ANSI Length Taps, refer to MCTI 302 on page 205.

EDP No.	SIZE	Thread Per Inch		Limit	No. of Flute
		UNC	UNF		
T7436082	2	56	—	H2	2
T7436122	3	48	—	H2	2
T7436161	4	40	—	H1	2
T7436162	4	40	—	H2	2
T7436182	4	—	48	H2	2
T7436202	5	40	—	H2	2
T7436242	6	32	—	H2	2
T7436243	6	32	—	H3	2
T7436262	6	—	40	H2	2
T7436282	8	32	—	H2	2
T7436283	8	32	—	H3	2
T7436302	8	—	36	H2	2
T7436322	10	24	—	H2	2
T7436323	10	24	—	H3	2
T7436342	10	—	32	H2	2
T7436343	10	—	32	H3	2
T7436402	1/4	20	—	H2	3
T7436403	1/4	20	—	H3	3
T7436422	1/4	—	28	H2	3
T7436423	1/4	—	28	H3	3
T7436443	5/16	18	—	H3	3
T7436444	5/16	18	—	H4	3
T7436462	5/16	—	24	H2	3
T7436463	5/16	—	24	H3	3
T7436483	3/8	16	—	H3	3
T7436484	3/8	16	—	H4	3
T7436502	3/8	—	24	H2	3
T7436503	3/8	—	24	H3	3
T7436523	7/16	14	—	H3	3
T7436524	7/16	14	—	H4	3
T7436543	7/16	—	20	H3	3
T7436544	7/16	—	20	H4	3
T7436563	1/2	13	—	H3	4
T7436564	1/2	13	—	H4	4
T7436583	1/2	—	20	H3	4
T7436584	1/2	—	20	H4	4

► For tapping depth on ANSI Length Taps, refer to MCTI 302 on page 205.

◎ : Excellent ○ : Good

Low carbon steels / Free machining carbon steels	Medium to high carbon steels / Low alloyed steels	Steel castings & forgings / Heat-treatable alloy steels	Alloyed tool steels / Mold steels	Free machining stainless steels	Heat-and corrosionresistant stainless steels / Valve stainless steels	Stainless steel castings / Precipitation hardening stainless steels	Pure Aluminum / Aluminum alloys			
◎	◎	○					○			
Aluminum alloy castings	Grey cast iron	Nodular cast iron / Chilled cast iron / Meehanite iron / Ductile iron	718 & 625 INCO / Waspaloy / Hastelloy / Invar / Monel / Incoloy	718 Inconel / A286	Titanium	Pure and alloyed copper	Free machining brass / Alloyed brass	Bronze	Zinc	Magnesium
○	○									

◎ : Excellent ○ : Good

Low carbon steels / Free machining carbon steels	Medium to high carbon steels / Low alloyed steels	Steel castings & forgings / Heat-treatable alloy steels	Alloyed tool steels / Mold steels	Free machining stainless steels	Heat-and corrosionresistant stainless steels / Valve stainless steels	Stainless steel castings / Precipitation hardening stainless steels	Pure Aluminum / Aluminum alloys			
○	○						○			
Aluminum alloy castings	Grey cast iron	Nodular cast iron / Chilled cast iron / Meehanite iron / Ductile iron	718 & 625 INCO / Waspaloy / Hastelloy / Invar / Monel / Incoloy	718 Inconel / A286	Titanium	Pure and alloyed copper	Free machining brass / Alloyed brass	Bronze	Zinc	Magnesium
○	○									

YG SCREW THREAD INSERT TAPS

T7415 SERIES

METRIC SPIRAL POINT TAPS SCREW THREAD INSERT for General Purpose

Hole type 3.0xD

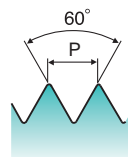
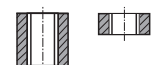

GS HSS M MF USCTI 322A D2-D4 60° 4P-5P Bright

EDP No.	SIZE	Pitch	Limit	No. of Flute
T7415132	M2	0.4	D2	2
T7415172	M2.5	0.45	D2	2
T7415202	M3	0.5	D2	3
T7415243	M4	0.7	D3	3
T7415283	M5	0.8	D3	3
T7415313	M6	1.0	D3	3
T7415363	M8	1.25	D3	3
T7415424	M10	1.5	D4	3
T7415504	M12	1.75	D4	3

► For tapping depth on ANSI Length Taps, refer to MCTI 302 on page 205.

◎ : Excellent ○ : Good

Low carbon steels/ Free machining carbon steels	Medium to high carbon steels/ Low alloyed steels	Steel castings & forgings / Heat-treatable alloy steels	Alloyed tool steels / Mold steels	Free machining stainless steels	Heat-and corrosionresistant stainless steels / Valve stainless steels	Stainless steel castings / Precipitation hardening stainless steels	Pure Aluminum/ Aluminum alloys				
○	○						○				
Aluminum alloy castings	Grey cast iron	Nodular cast iron / Chilled cast iron / Meehanite iron / Ductile iron	718 & 625 INCO / Waspaloy / Hastelloy / Invar / Monel / Incoloy	718 Inconel / A286	Titanium	Pure and alloyed copper	Free machining brass / Alloyed brass	Bronze	Zinc	Magnesium	
○	○										

YG SCREW THREAD INSERT TAPS

T7426 SERIES

STRAIGHT FLUTE TAPS SCREW THREAD INSERT for General Purpose

Hole type 2.0xD

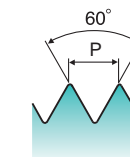
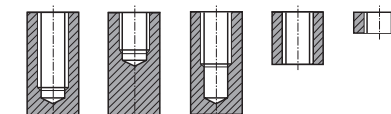

GS HSS UNC UNF USCTI 322 H1-H4 60° 4P-5P Plug 1.5P-2P Bottoming Bright

EDP No.		SIZE	Thread Per Inch		Limit	No. of Flute
Plug	Bottoming		UNC	UNF		
T7426087	T7426088	2	56	—	H2	3
T7426127	T7426128	3	48	—	H2	3
T7426167H1	T7426168H1	4	40	—	H1	3
T7426167	T7426168	4	40	—	H2	3
T7426187	T7426188	4	—	48	H2	3
T7426207	T7426208	5	40	—	H2	3
T7426247H2	T7426248H2	6	32	—	H2	3
T7426247	T7426248	6	32	—	H3	3
T7426267	T7426268	6	—	40	H2	3
T7426287H2	T7426288H2	8	32	—	H2	3
T7426287	T7426288	8	32	—	H3	3
T7426307	T7426308	8	—	36	H2	3
T7426327H2	T7426328H2	10	24	—	H2	3
T7426327	T7426328	10	24	—	H3	3
T7426347H2	T7426348H2	10	—	32	H2	3
T7426347	T7426348	10	—	32	H3	3
T7426407H2	T7426408H2	1/4	20	—	H2	3
T7426407	T7426408	1/4	20	—	H3	3
T7426427H2	T7426428H2	1/4	—	28	H2	3
T7426427	T7426428	1/4	—	28	H3	3
T7426447	T7426448	5/16	18	—	H3	4
T7426447H4	T7426448H4	5/16	18	—	H4	4
T7426467H2	T7426468H2	5/16	—	24	H2	4
T7426467	T7426468	5/16	—	24	H3	4
T7426487	T7426488	3/8	16	—	H3	4
T7426487H4	T7426488H4	3/8	16	—	H4	4
T7426507H2	T7426508H2	3/8	—	24	H2	4
T7426507	T7426508	3/8	—	24	H3	4
T7426527	T7426528	7/16	14	—	H3	4
T7426527H4	T7426528H4	7/16	14	—	H4	4
T7426547	T7426548	7/16	—	20	H3	4
T7426547H4	T7426548H4	7/16	—	20	H4	4
T7426567	T7426568	1/2	13	—	H3	4
T7426567H4	T7426568H4	1/2	13	—	H4	4
T7426587	T7426588	1/2	—	20	H3	4
T7426587H4	T7426588H4	1/2	—	20	H4	4

► For tapping depth on ANSI Length Taps, refer to MCTI 302 on page 204.

◎ : Excellent ○ : Good

Low carbon steels/ Free machining carbon steels	Medium to high carbon steels/ Low alloyed steels	Steel castings & forgings / Heat-treatable alloy steels	Alloyed tool steels / Mold steels	Free machining stainless steels	Heat-and corrosionresistant stainless steels / Valve stainless steels	Stainless steel castings / Precipitation hardening stainless steels	Pure Aluminum/ Aluminum alloys				
○	○						○				
Aluminum alloy castings	Grey cast iron	Nodular cast iron / Chilled cast iron / Meehanite iron / Ductile iron	718 & 625 INCO / Waspaloy / Hastelloy / Invar / Monel / Incoloy	718 Inconel / A286	Titanium	Pure and alloyed copper	Free machining brass / Alloyed brass	Bronze	Zinc	Magnesium	
○	○										

HSS

CARBIDE

Y/G SCREW THREAD INSERT TAPS

T7405 SERIES

METRIC STRAIGHT FLUTE TAPS SCREW THREAD INSERT for General Purpose

Hole type 2.0xD

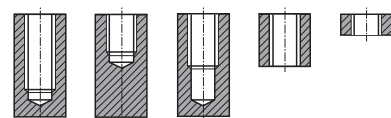

USCTI

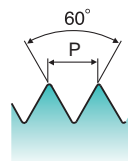

GS HSS M USCTI 322A D2-D4 4P~5P Plug 1.5P~2P Bottoming 60° Bright

	EDP No.		SIZE	Pitch	Limit	No. of Flute
	Plug	Bottoming				
	T7405137	T7405138	M2	0.4	D2	2
	T7405177	T7405178	M2.5	0.45	D2	2
	T7405207	T7405208	M3	0.5	D2	3
	T7405247	T7405248	M4	0.7	D3	3
	T7405287	T7405288	M5	0.8	D3	3
	T7405317	T7405318	M6	1.0	D3	3
	T7405367	T7405368	M8	1.25	D3	3
	T7405427	T7405428	M10	1.5	D4	3
	T7405507	T7405508	M12	1.75	D4	3

► For tapping depth on ANSI Length Taps, refer to MCTI 302 on page 204.



Being the best through innovation

HSS



PIPE TAPS

- Tapping NPT, NPTF, NPS & NPSF threads

◎ : Excellent ○ : Good

Low carbon steels / Free machining carbon steels	Medium to high carbon steels / Low alloyed steels	Steel castings & forgings / Heat-treatable alloy steels	Alloyed tool steels / Mold steels	Free machining stainless steels	Heat-and corrosionresistant stainless steels / Valve stainless steels	Stainless steel castings / Precipitation hardening stainless steels	Pure Aluminum / Aluminum alloys				
○	○						○				
Aluminum alloy castings	Grey cast iron	Nodular cast iron / Chilled cast iron / Meehanite iron / Ductile iron	718 & 625 INCO / Waspaloy / Hastelloy / Invar / Monel / Incoloy	718 Inconel / A286	Titanium	Pure and alloyed copper	Free machining brass / Alloyed brass	Bronze	Zinc	Magnesium	
○	○										

SELECTION GUIDE

PIPE TAPS

Tapping NPT, NPTF, NPS & NPSF threads

INCH

EDP No.	MODEL	Tool Material	Standard	Work Material	Dimensions	Tolerance	Chamfer	Thread Depth	Surface Treatment	Page
Q1/Q0/Q6		HSSE-V3	NPTF	VA	USCTI 311		2 ~ 3P	2.5D	Bright Steam Oxide Hardslick	187
Q9/R0/R1		HSSE-V3	NPTF	GG	USCTI 311		2 ~ 3P		Bright TiN Hardslick	188
R7/R8/R9/S0		HSSE-V3	NPTF	GG	USCTI 311		2 ~ 3P	2.0D	Bright TiN Hardslick Nitrided- Steam Oxide	189
S1/S2		HSSE-V3	NPTF	GG	USCTI 311		2 ~ 3P		Bright TiCN	190
T7L36/T6L36 T7536/T6536		HSS	NPS/NPSF	GS	USCTI 311		4 ~ 5P		Bright Steam Oxide	191
T7505/T6505/ TH505		HSS	NPT	GS	USCTI 311		2 ~ 3P	Bright Steam Oxide TiCN	192	
T7546/T8546		HSS	NPTF	GS	USCTI 311		2 ~ 3P	Bright TiN	193	

Y/G PIPE TAPS

Q1/Q0/Q6 SERIES

TAPER PIPE TAPS : SPIRAL FLUTE for Steels & Stainless Steels

Hole type 2.5xD

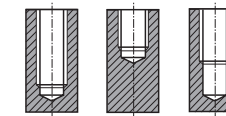

USCTI

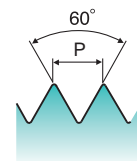

VA HSSE-V3 NPTF USCTI 311 60° 2P~3P Bright Steam Oxide Hardslick R15

EDP No.			SIZE	Thread Per Inch	No. of Flute
Bright	Steam Oxide	Hardslick			
Q1020	Q0020	Q6020	1/16	27	4
Q1200	Q0200	Q6200	1/8(Lg.)	27	4
Q1210	Q0210	Q6210	1/8(Sm.)	27	4
Q1400	Q0400	Q6400	1/4	18	4
Q1480	Q0480	Q6480	3/8	18	4
Q1560	Q0560	Q6560	1/2	14	4
Q1700	Q0700	Q6700	3/4	14	4
Q1780	Q0780	Q6780	1	11-1/2	4
Q1860	Q0860	Q6860	1-1/4	11-1/2	5
Q1960	Q0960	Q6960	1-1/2	11-1/2	7
Q1D20	Q0D20	Q6D20	2	11-1/2	7

▶ These Taps meet both NPT and NPTF Standards.

▶ For tapping depth on ANSI Length Taps, refer to MCTI 302 on page 202.

◎ : Excellent ○ : Good

Low carbon steels/ Free machining carbon steels	Medium to high carbon steels/ Low alloyed steels	Steel castings & forgings / Heat-treatable alloy steels	Alloyed tool steels / Mold steels	Free machining stainless steels	Heat-and corrosionresistant stainless steels / Valve stainless steels	Stainless steel castings / Precipitation hardening stainless steels	Pure Aluminum/ Aluminum alloys			
○	◎	○		◎	○					
Aluminum alloy castings	Grey cast iron	Nodular cast iron / Chilled cast iron / Meehanite iron / Ductile iron	718 & 625 INCO / Waspaloy / Hastelloy / Invar / Monel / Incoloy	718 Inconel / A286	Titanium	Pure and alloyed copper	Free machining brass / Alloyed brass	Bronze	Zinc	Magnesium
○		○								

Y/G PIPE TAPS

Q9/R0/R1 SERIES

TAPER PIPE TAPS : SPIRAL FLUTE for Cast Irons & Steels

Hole type 2.5xD

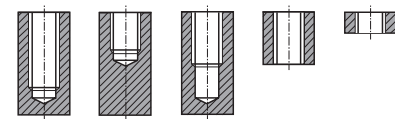

USCTI

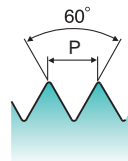

GG HSSE-V3 NPTF USCTI 311 60° 2P~3P Bright TiN Hardslick R15

EDP No.			SIZE	Thread Per Inch	No. of Flute
Bright	TiN	Hardslick			
Q9020	R0020	R1020	1/16	27	4
Q9200	R0200	R1200	1/8(Lg.)	27	4
Q9210	R0210	R1210	1/8(Sm.)	27	4
Q9400	R0400	R1400	1/4	18	4
Q9480	R0480	R1480	3/8	18	4
Q9560	R0560	R1560	1/2	14	4
Q9700	R0700	R1700	3/4	14	4
Q9780	R0780	R1780	1	11-1/2	4
Q9860	R0860	R1860	1-1/4	11-1/2	5
Q9960	R0960	R1960	1-1/2	11-1/2	7
Q9D20	R0D20	R1D20	2	11-1/2	7

▶ These Taps meet both NPT and NPTF Standards.
 ▶ For tapping depth on ANSI Length Taps, refer to MCTI 302 on page 202.

◎ : Excellent ○ : Good

Low carbon steels/ Free machining carbon steels	Medium to high carbon steels/ Low alloyed steels	Steel castings & forgings / Heat-treatable alloy steels	Alloyed tool steels / Mold steels	Free machining stainless steels	Heat-and corrosionresistant stainless steels / Valve stainless steels	Stainless steel castings / Precipitation hardening stainless steels	Pure Aluminum/ Aluminum alloys			
◎	◎	○								
Aluminum alloy castings	Grey cast iron	Nodular cast iron / Chilled cast iron / Meehanite iron / Ductile iron	718 & 625 INCO / Waspaloy / Hastelloy / Invar / Monel / Incoloy	718 Inconel / A286	Titanium	Pure and alloyed copper	Free machining brass / Alloyed brass	Bronze	Zinc	Magnesium
	◎	◎								

Y/G PIPE TAPS

R7/R8/R9/S0 SERIES

TAPER PIPE TAPS : STRAIGHT FLUTE for Cast Irons & Steels

Hole type 2.0xD

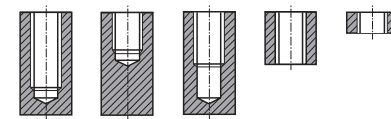

USCTI

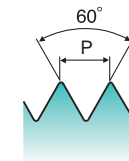

GG HSSE-V3 NPTF USCTI 311 60° 2P~3P Bright TiN Hardslick Nitrided Steam Oxide

EDP No.				SIZE	Thread Per Inch	No. of Flute
Bright	TiN	Hardslick	Nitrided Steam Oxide			
R7020	R8020	R9020	S0020	1/16	27	4
R7200	R8200	R9200	S0200	1/8(Lg.)	27	4
R7210	R8210	R9210	S0210	1/8(Sm.)	27	4
R7400	R8400	R9400	S0400	1/4	18	4
R7480	R8480	R9480	S0480	3/8	18	4
R7560	R8560	R9560	S0560	1/2	14	4
R7700	R8700	R9700	S0700	3/4	14	5
R7780	R8780	R9780	S0780	1	11-1/2	5
R7860	R8860	R9860	S0860	1-1/4	11-1/2	5
R7960	R8960	R9960	S0960	1-1/2	11-1/2	7
R7D20	R8D20	R9D20	S0D20	2	11-1/2	7

▶ These Taps meet both NPT and NPTF Standards.
 ▶ For tapping depth on ANSI Length Taps, refer to MCTI 302 on page 202.

◎ : Excellent ○ : Good

Low carbon steels/ Free machining carbon steels	Medium to high carbon steels/ Low alloyed steels	Steel castings & forgings / Heat-treatable alloy steels	Alloyed tool steels / Mold steels	Free machining stainless steels	Heat-and corrosionresistant stainless steels / Valve stainless steels	Stainless steel castings / Precipitation hardening stainless steels	Pure Aluminum/ Aluminum alloys			
◎	◎	○								
Aluminum alloy castings	Grey cast iron	Nodular cast iron / Chilled cast iron / Meehanite iron / Ductile iron	718 & 625 INCO / Waspaloy / Hastelloy / Invar / Monel / Incoloy	718 Inconel / A286	Titanium	Pure and alloyed copper	Free machining brass / Alloyed brass	Bronze	Zinc	Magnesium
	◎	◎								

Y/G PIPE TAPS

S1/S2 SERIES

TAPER PIPE TAPS : STRAIGHT FLUTE INTERRUPTED THREAD for Cast Irons & Steels

Hole type 2.0xD

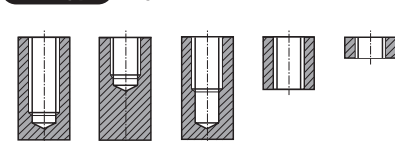

USCTI

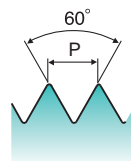

- GG
- HSSE-V3
- NPTF
- USCTI 311
- 60°
- 2P~3P
- Bright
- TiCN

EDP No.		SIZE	Thread Per Inch	No. of Flute
Bright	TiCN			
S1020	S2020	1/16	27	5
S1200	S2200	1/8(Lg.)	27	5
S1210	S2210	1/8(Sm.)	27	5
S1400	S2400	1/4	18	5
S1480	S2480	3/8	18	5
S1560	S2560	1/2	14	5
S1700	S2700	3/4	14	5
S1780	S2780	1	11-1/2	5

► These Taps meet both NPT and NPTF Standards.
 ► For tapping depth on ANSI Length Taps, refer to MCTI 302 on page 202.

◎ : Excellent ○ : Good

Low carbon steels/ Free machining carbon steels	Medium to high carbon steels/ Low alloyed steels	Steel castings & forgings / Heat-treatable alloy steels	Alloyed tool steels / Mold steels	Free machining stainless steels	Heat-and corrosionresistant stainless steels / Valve stainless steels	Stainless steel castings / Precipitation hardening stainless steels	Pure Aluminum/ Aluminum alloys				
◎	◎	○									
Aluminum alloy castings	Grey cast iron	Nodular cast iron / Chilled cast iron / Meehanite iron / Ductile iron	718 & 625 INCO / Waspaloy / Hastelloy / Invar / Monel / Incoloy	718 Inconel / A286	Titanium	Pure and alloyed copper	Free machining brass / Alloyed brass	Bronze	Zinc	Magnesium	
	◎	◎									

Y/G PIPE TAPS

T7L36/T6L36 SERIES
T7536/T6536 SERIES

STRAIGHT PIPE TAPS for General Purpose

Hole type 2.0xD

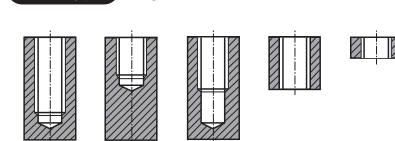

USCTI

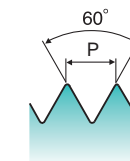

- GS
- HSS
- NPS NPSF
- USCTI 311
- 60°
- 4P~5P
- Bright
- Steam Oxide

T7L36 / T6L36 Series (NPS)

EDP No.		SIZE	Thread Per Inch	No. of Flute
Bright	Steam Oxide			
T7L36200	T6L36200	1/8 (Lg.)	27	4
T7L36210	T6L36210	1/8 (Sm.)	27	4
T7L36400	T6L36400	1/4	18	4
T7L36480	T6L36480	3/8	18	4
T7L36560	T6L36560	1/2	14	4
T7L36700	T6L36700	3/4	14	5
T7L36780	T6L36780	1	11-1/2	5

T7536 / T6536 Series (NPSF)

EDP No.		SIZE	Thread Per Inch	No. of Flute
Bright	Steam Oxide			
T7536200	T6536200	1/8 (Lg.)	27	4
T7536210	T6536210	1/8 (Sm.)	27	4
T7536400	T6536400	1/4	18	4
T7536480	T6536480	3/8	18	4
T7536560	T6536560	1/2	14	4
T7536700	T6536700	3/4	14	5
T7536780	T6536780	1	11-1/2	5

► For tapping depth on ANSI Length Taps, refer to MCTI 302 on page 202.

◎ : Excellent ○ : Good

Low carbon steels/ Free machining carbon steels	Medium to high carbon steels/ Low alloyed steels	Steel castings & forgings / Heat-treatable alloy steels	Alloyed tool steels / Mold steels	Free machining stainless steels	Heat-and corrosionresistant stainless steels / Valve stainless steels	Stainless steel castings / Precipitation hardening stainless steels	Pure Aluminum/ Aluminum alloys				
○	○						○				
Aluminum alloy castings	Grey cast iron	Nodular cast iron / Chilled cast iron / Meehanite iron / Ductile iron	718 & 625 INCO / Waspaloy / Hastelloy / Invar / Monel / Incoloy	718 Inconel / A286	Titanium	Pure and alloyed copper	Free machining brass / Alloyed brass	Bronze	Zinc	Magnesium	
○	○										

Y/G PIPE TAPS

T7505/T6505/TH505 SERIES

Y/G PIPE TAPS

T7546/T8546 SERIES

TAPER PIPE TAPS INTERRUPTED THREAD for General Purpose

TAPER PIPE TAPS 6" EXTENSION

Hole type 2.0xD

Hole type 2.0xD

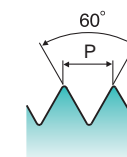
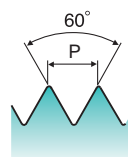
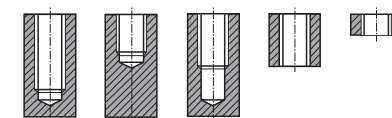
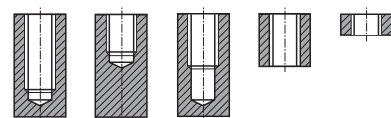

USCTI

USCTI

GS HSS NPT USCTI 311 60° 2P~3P Bright Steam Oxide TiCN

GS HSS NPTF USCTI 311 60° 2P~3P Bright TiN

EDP No.		SIZE	Thread Per Inch	No. of Flute
Bright	Steam Oxide			
T7505200	T6505200	TH505200	1/8 (Lg.)	5
T7505210	T6505210	TH505210	1/8 (Sm.)	5
T7505400	T6505400	TH505400	1/4	5
T7505480	T6505480	TH505480	3/8	5
T7505560	T6505560	TH505560	1/2	5
T7505700	T6505700	TH505700	3/4	5
T7505780	T6505780	TH505780	1"	5

EDP No.		SIZE	Threads Per Inch	Overall Length	Thread Length	Shank Diameter	No. of Flute
Bright	TiN			L	Lt	D	
T7546200	T8546200	1/8	27	6.0	3/4	.4375	4
T7546400	T8546400	1/4	18	6.0	1-1/16	.5625	4
T7546480	T8546480	3/8	18	6.0	1-1/16	.7000	4
T7546560	T8546560	1/2	14	6.0	1-3/8	.6875	4
T7546700	T8546700	3/4	14	6.0	1-3/8	.9063	5
T7546780	T8546780	1	11-1/2	6.0	1-3/4	1.1250	5

► For tapping depth on ANSI Length Taps, refer to MCTI 302 on page 202.

► For tapping depth on DIN / ANSI Shank Taps, refer to DIN Table on page 199 & 200.

◎ : Excellent ○ : Good

Low carbon steels / Free machining carbon steels	Medium to high carbon steels / Low alloyed steels	Steel castings & forgings / Heat-treatable alloy steels	Alloyed tool steels / Mold steels	Free machining stainless steels	Heat-and corrosionresistant stainless steels / Valve stainless steels	Stainless steel castings / Precipitation hardening stainless steels	Pure Aluminum / Aluminum alloys				
○	○						○				
Aluminum alloy castings	Grey cast iron	Nodular cast iron / Chilled cast iron / Meehanite iron / Ductile iron	718 & 625 INCO / Waspaloy / Hastelloy / Invar / Monel / Incoloy	718 Inconel / A286	Titanium	Pure and alloyed copper	Free machining brass / Alloyed brass	Bronze	Zinc	Magnesium	
○	○										

◎ : Excellent ○ : Good

Low carbon steels / Free machining carbon steels	Medium to high carbon steels / Low alloyed steels	Steel castings & forgings / Heat-treatable alloy steels	Alloyed tool steels / Mold steels	Free machining stainless steels	Heat-and corrosionresistant stainless steels / Valve stainless steels	Stainless steel castings / Precipitation hardening stainless steels	Pure Aluminum / Aluminum alloys				
○	○						○				
Aluminum alloy castings	Grey cast iron	Nodular cast iron / Chilled cast iron / Meehanite iron / Ductile iron	718 & 625 INCO / Waspaloy / Hastelloy / Invar / Monel / Incoloy	718 Inconel / A286	Titanium	Pure and alloyed copper	Free machining brass / Alloyed brass	Bronze	Zinc	Magnesium	
○	○										



Being the best through innovation

TAPS



TECHNICAL DATA



Global Cutting Tool Leader **YG-1**

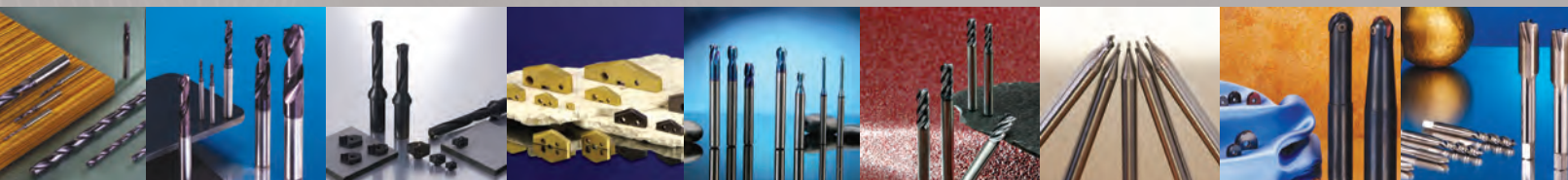

TAPS TERMINOLOGY

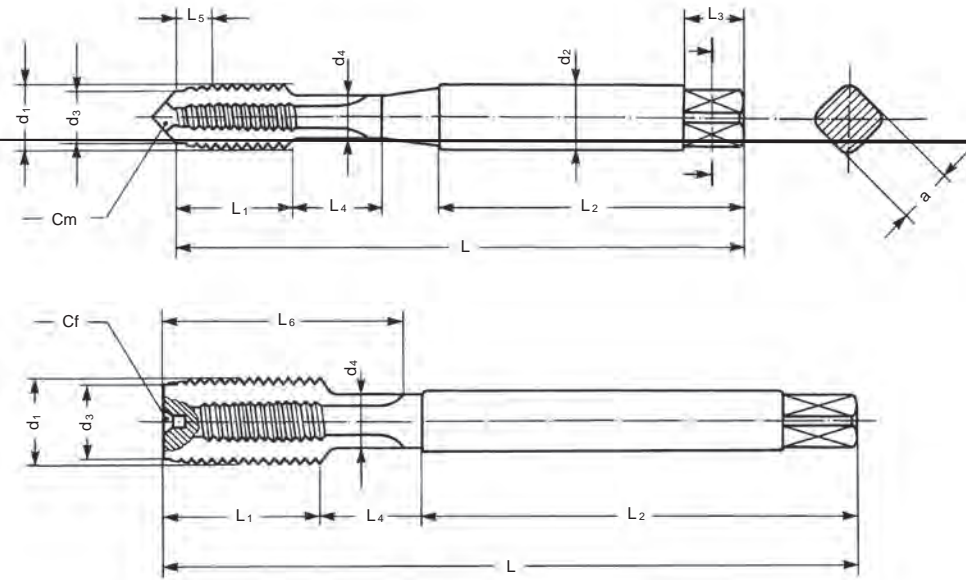

- d₁ Major diameter
- d₂ Shank diameter
- d₃ Chamfer diameter
- d₄ Neck diameter
- L Total length
- L₁ Thread length
- L₂ Shank length
- L₃ Square length
- L₄ Neck length
- L₅ Chamfer length
- L₆ Flutes length
- a Square size
- Cm Center male
- Cf Center female

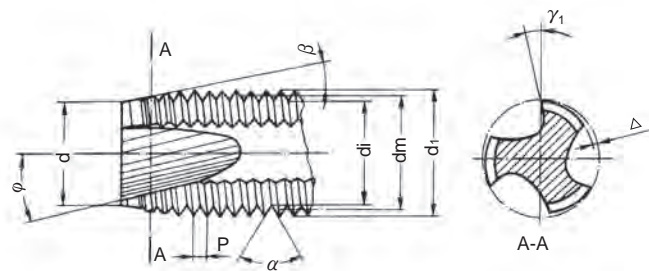

- d₁ Major diameter
- d_m Flank diameter
- d₁ Minor diameter
- d₃ Chamfer diameter
- P Pitch
- a Flank angle
- beta Chamfer angle
- phi Gun nose angle
- gamma Gun nose rake angle in front
- gamma_1 Chamfer relief
- Delta_1 Pitch diameter relief on the land
- gamma Rake angle
- T Width of land
- S Flute width
- d₅ Web tickness
- epsilon Angle of spiral flute

MODI TAP BLANK DIMENSION

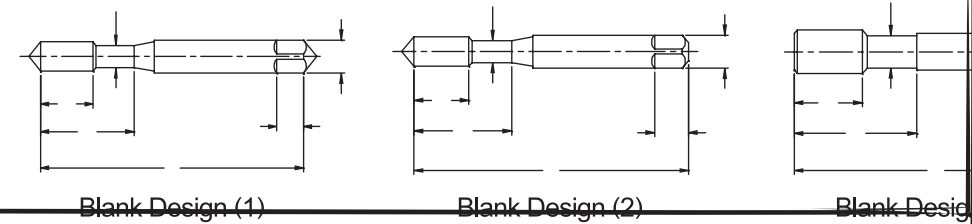

Nominal Size	Overall Length	Thread Length		Length to neck		Shank Diameter	Neck Diameter	Square Length	Square Size	Blank Design No.
	(L)	SF	SP	SF	SP					
#2	1.75	.157	.256	.689		.141	.061	.173	.110	1
#3	1.81	.197	.295	.563		.141	.069	.173	.110	1
#4	1.87	.236	.335	.563		.141	.077	.173	.110	1
#5	1.94	.236	.374	.626		.141	.090	.173	.110	1
#6	2.00	.276	.413	.689		.141	.094	.173	.110	1
#8	2.13	.276	.453	.752		.168	.120	.236	.131	1
#10-24	2.37	.354	.531	.906		.194	.131	.236	.152	1
#10-32		.276					.146			1
#12-24	2.37	.354	.571	.906		.220	.157	.268	.165	1
#12-28		.276					.166			2
1/4-20	2.52	.433	.591	1.000		.255	.180	.299	.191	2
1/4-28		.354					.200			2
5/16-18	2.74	.472	.669	1.126		.318	.234	.362	.238	2
5/16-24		.394					.254			2
3/8-16	2.97	.551	.748	1.252		.381	.287	.425	.286	2
3/8-24		.394					.316			3
7/16-14	3.16	.591	.866	1.850 1.437		.323	.311	.394	.242	3
7/16-20		.472								3
1/2-13	3.37	.630	.984	2.067 1.657		.367	.354	.425	.275	3
1/2-20		.472								3
9/16-12	3.59	.709	.984	2.067 1.657		.429	.417	.488	.322	3
9/16-18		.512								3
5/8-11	3.81	.748	1.083	2.205 1.811		.480	.469	.547	.360	3
5/8-18		.512								3
3/4-10	4.25	.827	1.201	2.480 2.000		.590	.577	.673	.442	3
3/4-10		.591								3
7/8-9	4.69	.827	1.339	2.815 2.220		.697	.685	.736	.523	3
7/8-14		.709								3
1"-8	5.13	.984	1.496	3.091 2.500		.800	.787	.799	.600	3
1"-12		.709								3
1"1/8-7	5.44	1.024	1.535	3.15 2.563		.896	.878	.88	.672	3
1"1/8-12		.787								3
1"1/4-7	5.75	1.024	1.535	3.15 2.563		1.021	1.002	1.00	.766	3
1"1/4-12		.787								3
1"3/8-6	6.06	1.181	1.791	3.583 3.000		1.108	1.088	1.06	.831	3
1"3/8-12		.866								3
1"1/2-6	6.38	1.181	1.791	3.583 3.000		1.233	1.212	1.13	.925	3
1"1/2-12		.866								3



3 MODI TAP BLANK DIMENSION - METRIC

4 HIGH PERFORMANCE TAPS DIN LENGTH / ANSI SHANK - INCH

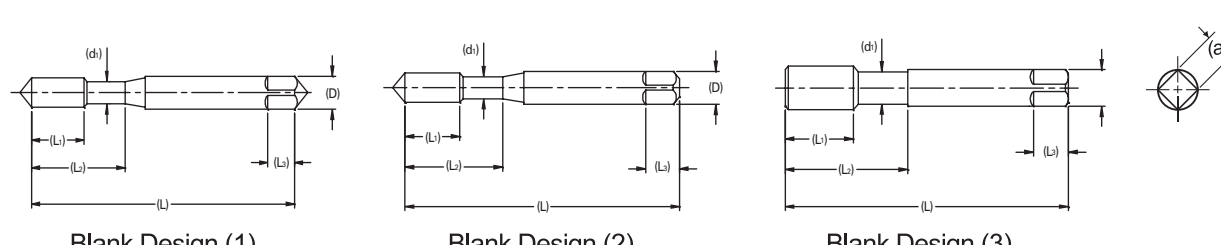
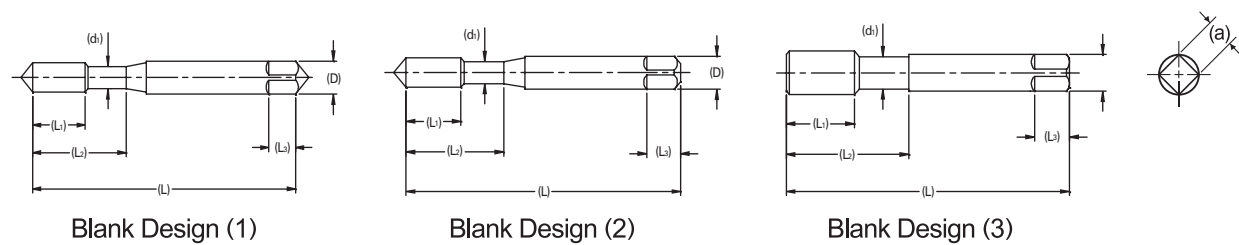

Metric Tap Blank

Nominal Size	Overall Length (L)	Thread Length (L1)		Length to neck (L2)		Shank Diameter (D)	Neck Diameter (d1)	Square Length (L3)	Square Size (a)	Blank Design No.
		SF	SP	SF	SP					
M3	1.94	.197	.374	.646		.141	.090	.173	.110	1
M3.5	2.00	.276	.413	.646		.141	.104	.173	.110	1
M4	2.13	.276	.453	.768		.168	.119	.236	.131	1
M4.5	2.37	.354	.531	.933		.194	.135	.236	.152	1
M5	2.37	.354	.531	.933		.194	.152	.236	.152	1
M5.5	2.37	.354	.571	1.000		.220	.189	.268	.165	2
M6	2.52	.433	.591	1.000		.255	.181	.299	.191	2
M7	2.74	.433	.669	1.126		.318	.220	.362	.238	2
M8x 1.25	2.74	.472	.669	1.126		.318	.246	.362	.238	2
M8x 1.0		.433								2
M10x 1.5	2.97	.512	.748	1.252		.381	.310	.425	.286	2
M10x 1.25		.472								2
M12x 1.75	3.37	.591	.984	2.067	1.657	.367	.354	.425	.275	3
M12x 1.25		.551								3
M14x 2.0	3.59	.709	.984	2.067	1.657	.429	.417	.488	.322	3
M14x 1.5		.551								3
M16x 2.0	3.81	.709	1.083	2.205	1.811	.480	.469	.547	.360	3
M16x 1.5		.551								3
M18x 2.5	4.03	.787	1.083	2.205	1.811	.542	.530	.610	.406	3
M18x 1.5		.551								3
M20x 1.5	4.47	.551	1.201	2.48	2.000	.652	.64	.69	.489	3
M20x 2.5		.787								3
M22x 1.5	4.69	.551	1.339	2.815	2.220	.697	.685	.75	.523	3
M22x 2.5		.787								3
M24x 1.5	4.91	.551	1.339	2.815	2.220	.76	.748	.75	.57	3
M24x 3		.945								3
M27x 1.5	5.13	.591	1.496	3.091	2.500	.896	.878	.88	.672	3
M27x 3		.945								3
M30x 1.5	5.44	.591	1.713	3.15	2.854	1.021	1.002	1.00	.766	3
M30x 3.5		1.102								3

*SF : Spiral Fluted Taps
*SP : Spiral Pointed Taps

Nominal Size	Overall Length (L)	Thread Length (L1)		Length to neck (L2)		Shank Diameter (D)	Neck Diameter (d1)	Square Length (L3)	Square Size (a)	Blank Design No.
		SF	SP	SF	SP					
#4	2.205	.236	.335	.563		.141	.077	.173	.110	1
#5	2.205	.236	.374	.626		.141	.090	.173	.110	1
#6	2.205	.276	.413	.689		.141	.094	.173	.110	1
#8	2.480	.276	.453	.752		.168	.120	.236	.131	1
#10-24	2.756	.354	.531	.906		.194	.131	.236	.152	1
#10-32		.276					1			
#12-24	3.150	.354	.571	.906		.220	.157	.268	.165	1
#12-28		.276					1			
1/4-20	3.150	.433	.591	1.000		.255	.180	.299	.191	2
1/4-28		.354					2			
5/16-18	3.543	.472	.669	1.126		.318	.234	.362	.238	2
5/16-24		.394					2			
3/8-16	3.937	.551	.748	1.252		.381	.287	.425	.286	2
3/8-24		.394					2			
7/16-14	3.937	.591	.866	1.850	1.437	.323	.311	.394	.242	3
7/16-20		.472					3			
1/2-13	4.331	.630	.984	2.067	1.657	.367	.354	.425	.275	3
1/2-20	3.937	.472								3
9/16-12	4.331	.709	.984	2.067	1.657	.429	.417	.488	.322	3
9/16-18	3.937	.512								3
5/8-11	4.331	.748	1.083	2.205	1.811	.480	.469	.547	.360	3
5/8-18	3.937	.512								3
3/4-10	4.921	.827	1.201	2.480	2.000	.590	.577	.673	.442	3
3/4-10	4.331	.591								3
7/8-9	5.512	.827	1.339	2.815	2.220	.697	.685	.736	.523	3
7/8-14	4.921	.709								3
1"-8	6.299	.984	1.496	3.091	2.500	.800	.787	.799	.600	3
1"-12	5.512	.709								3

*SF : Spiral Fluted Taps
*SP : Spiral Pointed Taps

5 HIGH PERFORMANCE TAPS DIN LENGTH / ANSI SHANK - METRIC

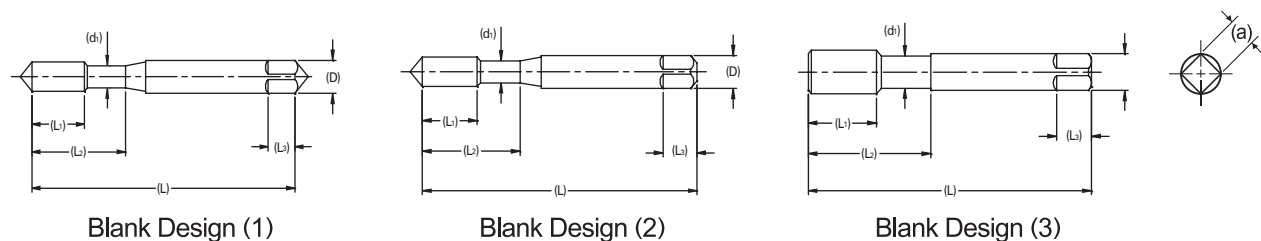

Nominal Size	Overall Length (L)	Thread Length (L ₁)		Length to neck (L ₂)		Shank Diameter (D)	Neck Diameter (d ₁)	Square Length (L ₃)	Square Size (a)	Blank Design No.
		SF	SP	SF	SP					
M3	2.21	.197	.374	.646		.141	.090	.173	.110	1
M3.5	2.21	.276	.413	.646		.141	.104	.173	.110	1
M4	2.48	.276	.453	.768		.168	.119	.236	.131	1
M5	2.76	.354	.531	.933		.194	.152	.236	.152	1
M6	3.15	.433	.591	1.000		.255	.181	.299	.191	2
M8x 1.25	3.54	.472	.669	1.126		.318	.246	.362	.238	2
M8x 1.0		.433								2
M10x 1.5	3.94	.512	.748	1.252		.381	.310	.425	.286	2
M10x 1.25		.472								2
M12x 1.75	4.331	.591	.984	2.067	1.657	.367	.354	.425	.275	3
M12x 1.25	3.937	.551								3
M14x 2.0	4.331	.709	.984	2.067	1.657	.429	.417	.488	.322	3
M14x 1.5	3.937	.551								3
M16x 2.0	4.331	.709	1.083	2.205	1.811	.480	.469	.547	.360	3
M16x 1.5	3.937	.551								3
M18x 2.5	4.931	.787	1.083	2.205	1.811	.542	.530	.610	.406	3
M18x 1.5	4.331	.551								3

*SF : Spiral Fluted Taps
*SP : Spiral Pointed Taps

6 YG-1 USCTI 302 TAP BLANK DIMENSION

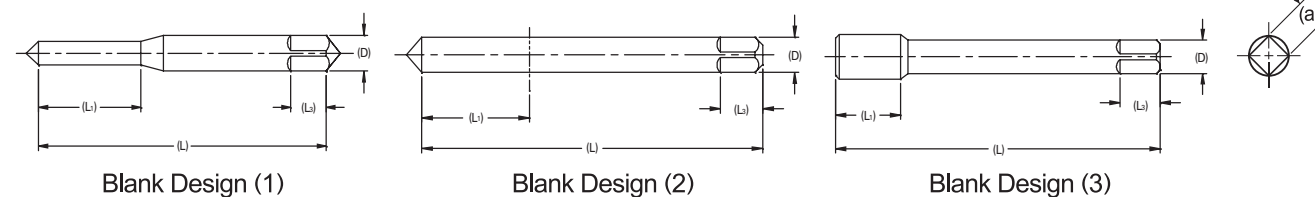

Unified Tap Blank (Inch)

Nominal Size	Overall Length	Thread Length	Shank Diameter	Square Length	Square Size	Blank Design No.
	(L)	(L ₁)	(D)	(L ₃)	(a)	
#0	1.63	.315	.141	.173	.110	1
#1	1.69	.374	.141	.173	.110	1
#2	1.75	.433	.141	.173	.110	1
#3	1.81	.492	.141	.173	.110	1
#4	1.87	.563	.141	.173	.110	1
#5	1.94	.626	.141	.173	.110	1
#6	2.00	.689	.141	.173	.110	1
#8	2.13	.752	.168	.236	.131	1
#10	2.37	.906	.194	.236	.152	1
#12	2.37	.906	.220	.268	.165	1
1/4	2.50	1.000	.255	.299	.191	2
5/16	2.72	1.126	.318	.362	.238	2
3/8	2.94	1.252	.381	.425	.286	2
7/16	3.16	1.437	.323	.394	.242	3
1/2	3.37	1.657	.367	.425	.275	3
9/16	3.59	1.657	.429	.488	.322	3
5/8	3.81	1.811	.480	.547	.360	3
11/16	4.03	1.811	.542	.610	.406	3
3/4	4.25	2.000	.590	.673	.442	3
13/16	4.47	2.000	.652	.673	.489	3
7/8	4.69	2.220	.697	.736	.523	3
15/16	4.91	2.220	.760	.736	.570	3
1"	5.13	2.500	.800	.799	.600	3

Unified Tap Blank (Metric)

Nominal Size	Overall Length	Thread Length	Shank Diameter	Square Length	Square Size	Blank Design No.
	(L)	(L ₁)	(D)	(L ₃)	(a)	
M1.6	1.63	.310	.141	.173	.110	1
M1.8	1.69	.380	.141	.173	.110	1
M2	1.75	.440	.141	.173	.110	1
M2.5	1.81	.500	.141	.173	.110	1
M3	1.94	.630	.141	.173	.110	1
M3.5	2.00	.690	.141	.173	.110	1
M4	2.13	.750	.168	.236	.131	1
M4.5	2.38	.880	.194	.236	.152	1
M5	2.38	.880	.194	.236	.165	1
M6	2.50	1.000	.255	.299	.191	2
M7	2.72	1.130	.318	.362	.238	2
M8	2.72	1.130	.318	.362	.238	2
M10	2.94	1.250	.381	.425	.286	2
M12	3.38	1.660	.367	.425	.275	3
M14	3.59	1.660	.429	.488	.322	3
M16	3.81	1.810	.480	.547	.360	3
M18	4.03	1.810	.542	.610	.406	3
M20	4.47	2.000	.652	.673	.489	3
M22	4.69	2.220	.697	.736	.523	3
M24	4.91	2.220	.760	.736	.570	3

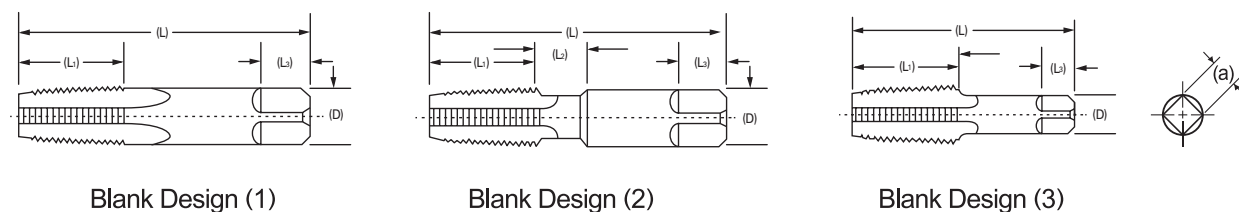
STANDARD PIPE TAP DIMENSION (STRAIGHT AND TAPER, GROUND THREAD)

Nominal Size	Overall Length	Thread Length	Shank Diameter	Square Length	Square Size	Optional Neck Length
	(L)	(L ₁)	(D)	(L ₂)	(a)	(L ₂)
1/16	2.13	.69	.3125	.38	.234	.375
1/8	2.13	.75	.3125	.38	.234	...
1/8	2.13	.75	.4375	.38	.328	.375
1/4	2.44	1.06	.5625	.44	.421	.375
3/8	2.56	1.06	.7000	.50	.531	.375
1/2	3.13	1.38	.6875	.63	.515	...
3/4	3.25	1.38	.9063	.69	.679	...
1"	3.75	1.75	1.1250	.81	.843	...
1-1/4	4.00	1.75	1.3125	.94	.984	...
1-1/2	4.25	1.75	1.5000	1.00	1.125	...
2"	4.25	1.75	1.8750	1.13	1.406	...
2-1/2	5.50	2.56	2.2500	1.25	1.687	...
3"	6.00	2.63	2.6250	1.38	1.968	...
3-1/2	6.50	2.69	2.8125	1.50	2.108	...
4"	6.75	2.75	3.0000	1.56	2.250	...

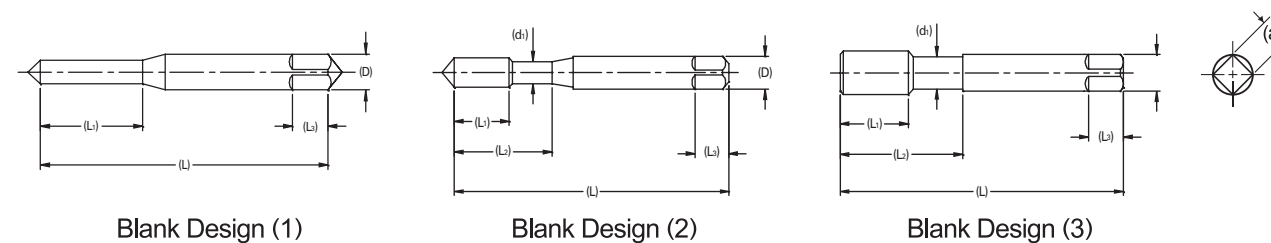
STANDARD FORMING TAP DIMENSION
**Forming Tap Blank (Inch)**

Nominal Size	Overall Length	Thread Length	Neck Length	Shank Diameter	Square Length	Square Size	Blank Design No.
	(L)	(L ₁)	(L ₂)	(D)	(L ₃)	(a)	
#0	1.63	.31	—	.141	.19	.110	1
#1	1.69	.38	—	.141	.19	.110	1
#2	1.75	.44	—	.141	.19	.110	1
#3	1.81	.50	—	.141	.19	.110	1
#4	1.87	.56	—	.141	.19	.110	1
#5	1.94	.63	—	.141	.19	.110	1
#6	2.00	.48	.69	.141	.19	.110	1
#8	2.13	.50	.75	.168	.25	.131	1
#10	2.38	.63	.88	.194	.25	.152	1
#12	2.38	.63	.94	.220	.28	.165	1
1/4	2.50	.86	1.0	.255	.31	.191	2
5/16	2.72	.93	1.13	.318	.38	.238	2
3/8	2.94	.98	1.25	.381	.44	.286	2
7/16	3.16	.95	1.44	.323	.41	.242	3
1/2	3.38	1.0	1.60	.367	.44	.275	3
9/16	3.59	1.0	1.66	.429	.50	.322	3
5/8	3.81	1.0	1.81	.480	.56	.360	3
3/4	4.25	1.0	2.0	.590	.69	.442	3

Forming Tap Blank (Metric)

Nominal Size	Overall Length	Thread Length	Neck Length	Shank Diameter	Square Length	Square Size	Blank Design No.
	(L)	(L ₁)	(L ₂)	(D)	(L ₃)	(a)	
M2	1.75	.40	—	.141	.19	.110	1
M3	1.94	.630	—	.141	.19	.110	1
M4	2.13	.50	.75	.168	.25	.131	1
M5	2.38	.63	.88	.194	.25	.152	1
M6	2.50	.86	1.0	.255	.31	.191	2
M8	2.72	.93	1.13	.318	.38	.238	2
M10	2.94	.98	1.25	.381	.44	.286	2
M12	3.38	1.0	1.60	.367	.44	.275	3



9 STI STRAIGHT TAP DIMENSION

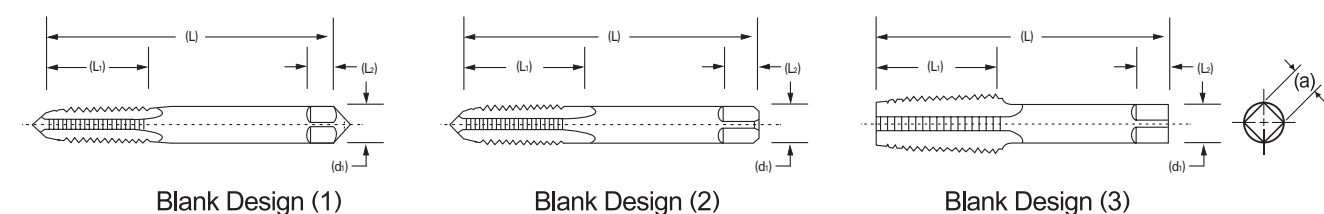

10 STI SPIRAL FLUTE & SPIRAL POINT TAP DIMENSION

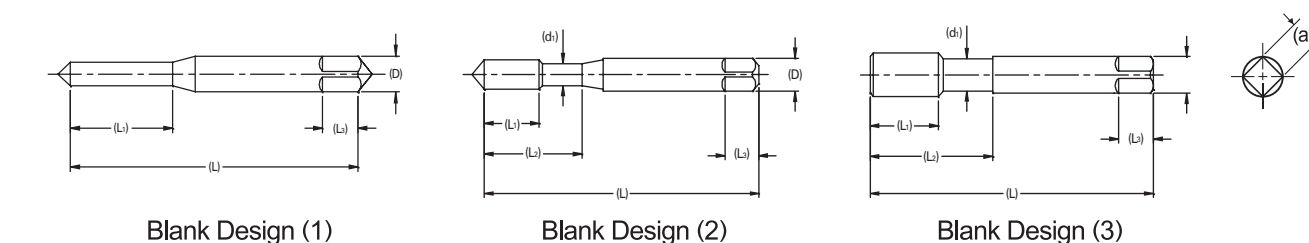

STI Tap blank (Inch)

Nominal Size (STI)	Threads per Inch		Overall Length (L)	Thread Length (L ₂)	Shank Diameter (D)	Square Length (L ₃)	Square Size (a)	Blank Design No.	Table 302 Blank Equivalent
	UNC	UNF							
	(L)	(L ₂)							
2	56	-	1.880	.560	.141	.190	.110	1	No.4
2		64	1.880	.560	.141	.190	.110	1	No.4
3	48	-	1.940	.630	.141	.190	.110	1	No.5
3		56	1.940	.630	.141	.190	.110	1	No.5
4	40	-	2.000	.690	.141	.190	.110	1	No.6
4		48	2.000	.690	.141	.190	.110	1	No.6
5	40	-	2.130	.750	.168	.250	.131	1	No.8
6	32	-	2.380	.880	.194	.250	.152	1	No.10
6		40	2.130	.750	.168	.250	.131	1	No.8
8	32	-	2.380	.940	.220	.280	.165	1	No.12
8		36	2.380	.940	.220	.280	.165	1	No.12
10	24	-	2.500	1.000	.255	.310	.191	2	1/4
10		32	2.500	1.000	.255	.310	.191	2	1/4
12	24	-	2.720	1.130	.318	.380	.238	2	5/16
1/4	20	-	2.720	1.130	.318	.380	.238	2	5/16
1/4		28	2.720	1.130	.318	.380	.238	2	5/16
5/16	18	-	2.940	1.250	.381	.440	.286	2	3/8
5/16		24	2.940	1.250	.381	.440	.286	2	3/8
3/8	16	-	3.380	1.660	.367	.440	.275	3	1/2
3/8		24	3.160	1.440	.323	.410	.242	3	7/16
7/16	14	-	3.590	1.660	.429	.500	.322	3	9/16
7/16		20	3.380	1.660	.367	.440	.275	3	1/2
1/2	13	-	3.810	1.810	.480	.560	.360	3	5/8
1/2		20	3.590	1.660	.429	.500	.322	3	9/16

STI Tap blank (Inch)

Nominal Size (STI)	Threads per Inch		Overall Length (L)	Thread Length		Neck Length (L ₂)	Shank Diameter (D)	Square Length (L ₃)	Square Size (a)	Blank Design No.	Table 302 Blank Equivalent
	UNC	UNF		SP	SF						
	(L)	(L ₂)		(L ₂)	(D)						
2	56	-	1.880	.335	.236	.56	.141	.190	.110	1	No.4
2		64	1.880	.335	.236	.56	.141	.190	.110	1	No.4
3	48	-	1.940	.374	.236	.63	.141	.190	.110	1	No.5
3		56	1.940	.374	.236	.63	.141	.190	.110	1	No.5
4	40	-	2.000	.413	.276	.68	.141	.190	.110	1	No.6
4		48	2.000	.413	.276	.68	.141	.190	.110	1	No.6
5	40	-	2.130	.453	.276	.75	.168	.250	.131	1	No.8
6	32	-	2.380	.531	.354	.88	.194	.250	.152	1	No.10
6		40	2.130	.453	.276	.75	.168	.250	.131	1	No.8
8	32	-	2.380	.571	.354	.94	.220	.280	.165	1	No.12
8		36	2.380	.571	.354	.94	.220	.280	.165	1	No.12
10	24	-	2.500	.591	.433	1.0	.255	.310	.191	2	1/4
10		32	2.500	.591	.433	1.0	.255	.310	.191	2	1/4
12	24	-	2.720	.669	.472	1.13	.318	.380	.238	2	5/16
1/4	20	-	2.720	.669	.472	1.13	.318	.380	.238	2	5/16
1/4		28	2.720	.669	.472	1.13	.318	.380	.238	2	5/16
5/16	18	-	2.940	.748	.551	1.25	.381	.440	.286	2	3/8
5/16		24	2.940	.748	.551	1.25	.381	.440	.286	2	3/8
3/8	16	-	3.380	.984	.630	1.66	.367	.440	.275	3	1/2
3/8		24	3.160	.866	.591	1.44	.323	.410	.242	3	7/16
7/16	14	-	3.590	.984	.709	1.66	.429	.500	.322	3	9/16
7/16		20	3.380	.984	.984	1.66	.367	.440	.275	3	1/2
1/2	13	-	3.810	1.083	.748	1.81	.480	.560	.360	3	5/8
1/2		20	3.590	.984	.709	1.66	.429	.500	.322	3	9/16

STI Tap blank (Metric)

Nominal Size (STI)	Thread Pitch (mm)	Overall Length (L)	Thread Length (L ₂)	Shank Diameter (D)	Square Length (L ₃)	Square Size (a)	Blank Design No.	Table 302 Blank Equivalent
M2.5	0.45	1.940	.630	.141	.190	.110	1	No.5
M3	0.5	2.000	.690	.141	.190	.110	1	No.6
M4	0.7	2.380	.880	.194	.250	.152	1	No.10
M5	0.8	2.500	1.000	.255	.310	.191	2	1/4
M6	1	2.720	1.130	.318	.380	.238	2	5/16
M8	1.25	2.940	1.250	.381	.440	.286	2	3/8
M10	1.5	3.380	1.660	.367	.440	.275	3	1/2
M12	1.75	3.590	1.660	.429	.500	.322	3	9/16

STI Tap blank (Metric)

Nominal Size (STI)	Thread Pitch (mm)	Overall Length (L)	Thread Length		Neck Length (L ₂)	Shank Diameter (D)	Square Length (L ₃)	Square Size (a)	Blank Design No.	Table 302 Blank Equivalent
			SP	SF						
M2	0.4	1.81	.295	.236	.56	.141	.190	.110	1	
M2.5	0.45	1.940	.374	.197	.63	.141	.190	.110	1	No.5
M3	0.5	2.000	.413	.276	.69	.141	.190	.110	1	No.6
M4	0.7	2.380	.531	.354	.93	.194	.250	.152	1	No.10
M5	0.8	2.500	.591	.433	1.0	.255	.310	.191	2	1/4
M6	1	2.720	.669	.433	1.13	.318	.380	.238	2	5/16
M8	1.25	2.940	.748	.512	1.25	.381	.440	.286	2	3/8
M10	1.5	3.380	.984	.591	2.07	.367	.440	.275	3	1/2
M12	1.75	3.590	.984	.709	2.07	.429	.500	.322	3	9/16



11 TAP RECOMMENDATIONS FOR CLASSES OF THREAD - INCH

Internal Screw Thread Classes and Tap Recommendations

Size	Threads per Inch		Recommended Tap for Class of Thread				Pitch Diameter Limits for Class of Thread				
	UNC	UNF	Unified Class of Thread		American National Class of Thread		Min. All Class (Basic)	Unified Class of Thread		American National Class of Thread	
			Class 2	Class 3	Class 2B	Class 3B		Max. Class 2	Max. Class 3	Max. Class 2B	Max. Class 3B
0	-	80	GH1	GH1	GH2	GH1	.0519	.0536	.0532	.0542	.0536
1	64	-	GH1	GH1	GH2	GH1	.0629	.0648	.0643	.0655	.0648
1	-	72	GH1	GH1	GH2	GH1	.0640	.0658	.0653	.0665	.0659
2	56	-	GH1	GH1	GH2	GH1	.0744	.0764	.0759	.0772	.0765
2	-	64	GH1	GH1	GH2	GH1	.0759	.0778	.0773	.0786	.0779
3	48	-	GH1	GH1	GH2	GH1	.0855	.0877	.0871	.0885	.0877
3	-	56	GH1	GH1	GH2	GH1	.0874	.0894	.8890	.0902	.0895
4	40	-	GH2	GH1	GH2	GH2	.0958	.0982	.0975	.0991	.0982
4	-	48	GH1	GH1	GH2	GH1	.0985	.1007	.1001	.1016	.1008
5	40	-	GH2	GH1	GH2	GH2	.1088	.1112	.1105	.1121	.1113
5	-	44	GH1	GH1	GH2	GH1	.1102	.1125	.1118	.1134	.1126
6	32	-	GH2	GH1	GH3	GH2	.1177	.1204	.1196	.1214	.1204
6	-	40	GH2	GH1	GH2	GH2	.1218	.1242	.1235	.1252	.1243
8	32	-	GH2	GH1	GH3	GH2	.1437	.1464	.1456	.1475	.1465
8	-	36	GH2	GH1	GH2	GH2	.1460	.1485	.1478	.1496	.1487
10	24	-	GH3	GH1	GH3	GH3	.1629	.1662	.1653	.1672	.1661
10	-	32	GH2	GH1	GH3	GH2	.1697	.1724	.1716	.1736	.1726
12	24	-	GH3	GH1	GH3	GH3	.1889	.1922	.1913	.1933	.1922
12	-	28	GH3	GH1	GH3	GH3	.1928	.1959	.1950	.1970	.1959
1/4	20	-	GH3	GH2	GH5	GH3	.2175	.2211	.2201	.2223	.2211
1/4	-	28	GH3	GH1	GH4	GH3	.2268	.2299	.2290	.2311	.2300
5/16	18	-	GH3	GH2	GH5	GH3	.2764	.2805	.2794	.2817	.2803
5/16	-	24	GH3	GH1	GH4	GH3	.2854	.2887	.2878	.2902	.2890
3/8	16	-	GH3	GH2	GH5	GH3	.3344	.3389	.3376	.3401	.3387
3/8	-	24	GH3	GH1	GH4	GH3	.3479	.3512	.3503	.3528	.3516
7/16	14	-	GH5	GH3	GH5	GH3	.3911	.3960	.3947	.3972	.3957
7/16	-	20	GH3	GH1	GH5	GH3	.4050	.4086	.4076	.4104	.4091
1/2	13	-	GH5	GH3	GH5	GH3	.4500	.4552	.4537	.4565	.4548
1/2	-	20	GH3	GH1	GH5	GH3	.4675	.4711	.4701	.4731	.4717
9/16	12	-	GH5	GH3	GH5	GH3	.5084	.5140	.5124	.5152	.5135
9/16	-	18	GH3	GH2	GH5	GH3	.5264	.5305	.5294	.5323	.5308
5/8	11	-	GH5	GH3	GH5	GH3	.5660	.5719	.5702	.5732	.5714
5/8	-	18	GH3	GH2	GH5	GH3	.5889	.5930	.5919	.5949	.5934
3/4	10	-	GH5	GH3	GH5	GH3	.6850	.6914	.6895	.6927	.6907
3/4	-	16	GH3	GH2	GH5	GH3	.7094	.7139	.7126	.7159	.7143
7/8	9	-	GH6	GH4	GH6	GH4	.8028	.8098	.8077	.8110	.8089
7/8	-	14	GH4	GH2	GH6	GH4	.8286	.8335	.8322	.8356	.8339
1	8	-	GH6	GH4	GH6	GH4	.9188	.9264	.9242	.9276	.9254
1	-	12	GH4	GH2	GH6	GH4	.9459	.9515	.9499	.9535	.9516

The above recommended taps normally produce the Class of Thread indicated in average materials when used with reasonable care. However, if the tap specified does not give a satisfactory gage fit in the work, a choice of some other limit tap will be necessary.



12 TAP RECOMMENDATIONS FOR CLASSES OF THREAD - METRIC

Size	Pitch	Recommended Tap for Class of Thread		Pitch Diameter Limits for Class of Thread (mm)			Pitch Diameter Limits for Class of Thread (inch)		
		4H	6H	Min. (Basic)	Max. 4H	Max. 6H	Min. (Basic)	Max. 4H	Max. 6H
M1.6	0.35	D1	D3	1.373	1.426	1.458	.05406	.05614	.05740
M2	0.40	D1	D3	1.740	1.796	1.830	.06850	.07071	.07205
M2.5	0.45	D1	D3	2.208	2.268	2.303	.08693	.08929	.09067
M3	0.50	D1	D3	2.675	2.738	2.775	.10531	.10780	.10925
M3.5	0.60	D1	D4	3.110	3.181	3.222	.12244	.12524	.12685
M4	0.70	D2	D4	3.545	3.620	3.663	.13957	.14252	.14421
M4.5	0.75	D2	D4	4.013	4.088	4.131	.15789	.16094	.16264
M5	0.80	D2	D4	4.480	4.560	4.605	.17638	.17953	.18130
M6	1.00	D3	D5	5.350	5.445	5.500	.21063	.21437	.21654
M7	1.00	D3	D5	6.350	6.445	6.500	.25000	.25374	.25591
M8	1.25	D3	D5	7.188	7.288	7.348	.28299	.28693	.28929
M10	1.50	D3	D6	9.026	9.138	9.206	.35535	.35976	.36244
M12	1.75	D3	D6	10.863	10.988	11.063	.42768	.43260	.43555
M14	2.00	D3	D7	12.701	12.833	12.913	.50004	.50524	.50839
M16	2.00	D4	D7	14.701	14.833	14.913	.57878	.58398	.58713
M20	2.50	D4	D7	18.376	18.516	18.600	.72346	.72898	.73228
M24	3.00	D4	D8	22.051	22.221	22.316	.86815	.87484	.87858
M30	3.50	D5	D9	27.727	27.907	28.007	1.09161	1.0987	1.10264
M36	4.00	D5	D9	33.402	33.592	33.702	1.31504	1.32252	1.32685

13 TOLERANCE CHART - USCTI

Element	Nominal Diameter Range in Inches		Direction	Tolerance (Inches)
	Over	To (Inc.)		
Overall Length - L	.0520	1.0100	Plus or Minus	.031
	1.0100	4.0100	Plus or Minus	.063
Thread Length - L1	.0520	.2230	Plus or Minus	.047
	.2230	.5100	Plus or Minus	.063
	.5100	1.5100	Plus or Minus	.094
	1.5100	4.0100	Plus or Minus	.125
Square Length - L3	.0520	1.0100	Plus or Minus	.031
	1.0100	4.0100	Plus or Minus	.063
Shank Diameter - D	.0520	.2230	Minus	.0015
	.2230	.6350	Minus	.0015
	.6350	1.0100	Minus	.0020
	1.0100	1.5100	Minus	.0020
	1.5100	2.0100	Minus	.0030
	2.0100	4.0100	Minus	.0030
Square Size - a	.0520	.5100	Minus	.004
	.5100	1.0100	Minus	.006
	1.0100	2.0100	Minus	.008
	2.0100	4.0100	Minus	.010



14 THREAD LIMITS

Unified Thread, Machine Screw Size - Ground Thread

Size	Thread per Inch			Major Diameter (Inches)			Pitch Diameter Limits (Inches)								
	UNC	UNF	UNS	Basic	Min.	Max.	H1 Limit		H2 Limit		H3 Limit		H7 Limit		
							Min.	Max.	Min.	Max.	Min.	Max.	Min.	Max.	
0	-	80	-	.0600	.0605	.0615	.0519	.0519	.0524	.0524	.0529	-	-	-	-
1	64	-	-	.0730	.0735	.0745	.0629	.0629	.0634	.0634	.0639	-	-	-	-
2	56	-	-	.0860	.0865	.0875	.0744	.0744	.0749	.0749	.0754	-	-	-	-
3	48	-	-	.0990	.0100	.1010	.0855	.0855	.0860	.0860	.0865	-	-	-	-
4	40	-	36	.1120	.1135	.1145	.0940	-	-	.0945	.0950	-	-	-	-
5	40	-	-	.1250	.1265	.1275	.1088	.1088	.1093	.1093	.1098	-	-	-	-
6	32	-	-	.1380	.1400	.1410	.1177	.1177	.1182	.1182	.1187	.1187	.1192	.1207	.1212
8	32	-	-	.1640	.1660	.1670	.1437	.1437	.1442	.1442	.1447	.1447	.1452	.1467	.1472
10	24	-	-	.1900	.1930	.1940	.1629	.1629	.1634	.1634	.1639	.1639	.1644	.1659	.1664
12	24	-	-	.2160	.2190	.2200	.1889	-	-	-	-	.1899	.1904	-	-

Lead Tolerance

A maximum lead deviation of plus or minus .0005" within any two threads not farther apart than 1" is permitted

Pitch Diameter Limits

- H1 = Basic to basic plus .0005"
- H2 = Basic plus .0005" to basic plus .001"
- H3 = Basic plus .001" to basic plus .0015"
- H7 = Basic plus .003" to basic plus .0035"

Angle Tolerance

24 to 80 threads per inch incl. = 30 plus or minus in 1/2 angle.



Unified Thread, Machine Screw Size - Ground Thread

Size	Thread per Inch			Major Diameter (Inches)			Pitch Diameter Limits (Inches)												
	UNC	UNF	UNS	Basic	Min.	Max.	Basic Pitch Dia.	H1 Limit		H2 Limit		H3 Limit		H4 Limit		H5 Limit		H6 Limit	
								Min.	Max.	Min.	Max.	Min.	Max.	Min.	Max.	Min.	Max.		
1/4	20	-	-	.2500	.2540	.2550	.2175	.2175	.2180	.2180	.2185	.2185	.2190	-	-	.2195	.2200	-	-
5/16	18	-	-	.3125	.3170	.3180	.2764	.2764	.2769	.2769	.2774	.2774	.2779	-	-	.2784	.2789	-	-
3/8	16	-	-	.3750	.3800	.3810	.3344	.3344	.3349	.3349	.3354	.3354	.3359	-	-	.3364	.3369	-	-
7/16	14	-	-	.4375	.4435	.4445	.3911	-	-	.3916	.3921	.3921	.3926	-	-	.3931	.3936	-	-
1/2	13	-	-	.5000	.5065	.5075	.4500	.4500	.4505	.4505	.4510	.4510	.4515	-	-	.4520	.4525	-	-
9/16	12	-	-	.5625	.5690	.5700	.5084	-	-	.5089	.5094	.5094	.5099	-	-	.5104	.5109	-	-
5/8	11	-	-	.6250	.6320	.6330	.5660	-	-	.5665	.5670	.5670	.5675	-	-	.5680	.5685	-	-
11/16	-	-	11	.6875	.6945	.6955	.6285	-	-	-	-	.6295	.6300	-	-	-	-	-	-
3/4	10	-	-	.7500	.7525	.7590	.6850	.6850	.6855	.7099	.7104	.6860	.6865	-	-	.6870	.6875	-	-
7/8	9	-	-	.8750	.8835	.8850	.8028	-	-	.8291	.8296	-	-	-	-	.8043	.8048	-	-
1"	8	-	-	1.0000	1.0095	1.0110	.9188	-	-	-	-	-	-	-	-	.9203	.9208	-	-

Lead Tolerance

A maximum lead deviation of plus or minus .0005" within any two threads not farther apart than 1" is permitted

Pitch Diameter Limits

- H1 = Basic to basic plus .0005"
- H2 = Basic plus .0005" to basic plus .001"
- H3 = Basic plus .001" to basic plus .0015"
- H4 = Basic plus .0015" to basic plus .0020"
- H5 = Basic plus .0020" to basic plus .0025"
- H6 = Basic plus .0025" to basic plus .0030"

Angle Tolerance

Threads per Inch	Deviation in Half Angle
6 to 9 Incl. 10 to 28 Incl.	25' Plus or Minus 30' Plus or Minus

Metric Thread - Ground Thread

Size	Pitch		Major Diameter (Inches)			Pitch Diameter Limits (Inches)										
	Coarse	Fine	Basic	Min.	Max.	Basic Pitch Dia.	D2 Limit		D3 Limit		D4 Limit		D5 Limit		D6 Limit	
							Min.	Max.	Min.	Max.	Min.	Max.	Min.	Max.	Min.	Max.
M2	0.4	-	.0787	.0801	.0811	.0685	.0690	.0696	.0695	.0701	.0700	.0706	-	-	-	-
M2.2	0.45	-	.0866	.0881	.0891	.0751	.0756	.0762	.0761	.0767	.0766	.0772	-	-	-	-
M2.3	0.4	-	.0906	.0919	.0929	.0803	.0808	.0814	.0813	.0819	.0818	.0824	-	-	-	-
M2.6	0.45	-	.1024	.1038	.1048	.0909	.0913	.0919	.0918	.0924	.0923	.0929	-	-	-	-
M3	0.5	-	.1181	.1198	.1208	.1053	.1058	.1064	.1063	.1069	.1068	.1074	.1073	.1079	-	-
	-	0.35	.1181	.1193	.1203	.1092	.1096	.1102	.1101	.1107	.1106	.1112	.1111	.1117	-	-
M3.5	0.6	-	.1378	.1397	.1407	.1225	.1227	.1235	.1232	.1240	.1237	.1245	.1242	.1250	-	-
	-	0.35	.1378	.1389	.1399	.1289	.1293	.1299	.1298	.1304	.1303	.1309	.1308	.1314	-	-
M4	0.7	-	.1575	.1597	.1613	.1396	.1398	.1406	.1403	.1411	.1408	.1416	.1413	.1421	-	-
	-	0.5	.1575	.1591	.1601	.1447	.1451	.1457	.1456	.1462	.1461	.1467	.1466	.1472	-	-
M5	0.8	-	.1969	.1994	.2010	.1764	.1766	.1774	.1771	.1779	.1776	.1784	.1781	.1789	-	-
	-	0.5	.1969	.1985	.1995	.1841	.1845	.1851	.1850	.1856	.1855	.1861	.1861	.1866	-	-
M6	1	-	.2362	.2395	.2411	.2106	.2107	.2117	.2112	.2122	.2117	.2122	.2122	.2132	.2127	.2137
	-	0.75	.2362	.2387	.2403	.2170	.2173	.2181	.2178	.2186	.2183	.2191	.2188	.2196	.2193	.2201
M7	1	-	.2756	.2788	.2804	.2500	.2501	.2511	.2506	.2516	.2511	.2521	.2516	.2526	.2521	.2531
	-	0.75	.2756	.2780	.2796	.2564	.2565	.2575	.2570	.2580	.2575	.2585	.2580	.2590	.2585	.2595
M8	1.25	-	.3150	.3189	.3214	.2830	.2828	.2840	.2833	.2845	.2838	.2850	.2843	.2855	.2848	.2860
	-	1	.3150	.3182	.3198	.2894	.2894	.2904	.2899	.2909	.2904	.2914	.2909	.2919	.2914	.2924
M10	1.5	-	.3937	.3984	.4009	.3553	.3552	.3564	.3557	.3569	.3562	.3574	.3567	.3579	.3572	.3584
	-	1.25	.3937	.3976	.4001	.3617	.3616	.3628	.3621	.3633	.3626	.3638	.3631	.3643	.3636	.3648
		1	.3937	.3969	.3985	.3681	.3682	.3692	.3687	.3697	.3692	.3702	.3697	.3707	.3702	.3712
M12	1.75	-	.4724	.4780	.4805	.4277	.4275	.4287	.4280	.4292	.4285	.4297	.4290	.4302	.4295	.4307
	-	1.5	.4724	.4772	.4797	.4341	.4339	.4351	.4344	.4356	.4349	.4361	.4354	.4366	.4359	.4371
	-	1.25	.4724	.4764	.4789	.4405	.4403	.4415	.4408	.4420	.4413	.4425	.4418	.4430	.4423	.4435

Lead Tolerance

The tap major and pitch diameter conversions have been rounded upward.
 A maximum lead deviation of +/- .0005" within any two threads not further apart than 1" is permitted

Angle Tolerance

Pitch(mm)	Deviation in Half Angle
Over 0.25 to 2.5 Incl.	30' Plus or Minus
Over 2.5 to 4.0 Incl.	25' Plus or Minus

Metric Thread - Ground Thread

Size	Pitch		Major Diameter (Inches)			Pitch Diameter Limits (Inches)										
	Coarse	Fine	Basic	Min.	Max.	Basic Pitch Dia.	D2 Limit		D3 Limit		D4 Limit		D5 Limit			
							Min.	Max.	Min.	Max.	Min.	Max.	Min.	Max.		
M14	2	-	.5512	.5575	.5600	.5000	.5015	.5031	.5020	.5036	.5025	.5041	-	-		
	-	1.5	.5512	.5559	.5584	.5128	.5147	.5159	.5152	.5164	.5157	.5169	-	-		
	-	1.25	.5512	.5551	.5576	.5192	.5211	.5223	.5216	.5228	.5221	.5233	-	-		
M16	2	-	.6299	.6363	.6388	.5788	.5802	.5818	.5807	.5823	.5812	.5828	-	-		
	-	1.5	.6299	.6347	.6372	.5916	.5934	.5946	.5939	.5951	.5944	.5956	-	-		
M18	2.5	-	.7087	.7166	.7191	.6448	.6462	.6478	.6467	.6483	.6472	.6488	-	-		
	-	2	.7087	.7150	.7175	.6576	.6590	.6606	.6595	.6611	.6600	.6616	-	-		
	-	1.5	.7087	.7134	.7159	.6703	.6722	.6734	.6727	.6739	.6732	.6744	-	-		
M20	2.5	-	.7874	.7953	.7976	.7235	.7249	.7265	.7254	.7270	.7259	.7275	-	-		
	-	2	.7874	.7937	.7962	.7363	.7377	.7393	.7382	.7398	.7387	.7403	-	-		
	-	1.5	.7874	.7921	.7946	.7490	.7509	.7521	.7514	.7526	.7519	.7531	-	-		
	-	1	.7874	.7906	.7922	.7618	.7639	.7649	.7644	.7654	.7649	.7659	-	-		
M22	2.5	-	.8661	.8741	.8766	.8022	.8037	.8053	.8042	.8058	.8047	.8063	-	-		
	-	2	.8661	.8725	.8750	.8150	.8164	.8180	.8169	.8185	.8174	.8190	-	-		
	-	1.5	.8661	.8709	.8734	.8278	.8296	.8308	.8301	.8313	.8306	.8318	-	-		
	-	1	.8661	.8694	.8710	.8406	.8426	.8436	.8431	.8441	.8436	.8446	-	-		
M24	3	-	.9449	.9544	.9583	.8682	.8696	.8712	.8701	.8717	.8706	.8722	.8711	.8727		
	-	2	.9449	.9512	.9537	.8938	.8952	.8968	.8957	.8973	.8962	.8978	-	-		
	-	1.5	.9449	.9496	.9521	.9065	.9084	.9096	.9089	.9101	.9094	.9106	-	-		
	-	1	.9449	.9481	.9497	.9193	.9214	.9224	.9219	.9229	.9224	.9234	-	-		
M27	3	-	1.0630	1.0725	1.0764	.9863	.9873	.9893	.9878	.9898	.9883	.9903	.9888	.9908		
	-	2	1.0630	1.0693	1.0718	1.0118	1.0133	1.0149	1.0138	1.0154	1.0143	1.0159	-	-		
	-	1.5	1.0630	1.0677	1.0702	1.0246	1.0265	1.0277	1.0270	1.0282	1.0275	1.0287	-	-		
	-	1	1.0630	1.0662	1.0678	1.0374	1.0393	1.0405	1.0398	1.0410	1.0403	1.0415	-	-		
M28	-	2	1.1024	1.1087	1.1112	1.0512	1.0527	1.0543	1.0532	1.0548	1.0537	1.0553	-	-		
	-	1.5	1.1024	1.1071	1.1096	1.0640	1.0659	1.0671	1.0664	1.0676	1.0669	1.0681	-	-		
	-	1	1.1024	1.1056	1.1072	1.0768	1.0786	1.0798	1.0791	1.0803	1.0796	1.0808	-	-		
M30	3.5	-	1.1811	1.1921	1.1961	1.0916	1.0926	1.0946	1.0931	1.0951	1.0936	1.0956	1.0941	1.0961		
	-	3	1.1811	1.1906	1.1945	1.1044	1.1054	1.1074	1.1059	1.1079	1.1064	1.1084	1.1069	1.1089		
	-	2	1.1811	1.1874	1.1899	1.1300	1.1314	1.1330	1.1319	1.1335	1.1324	1.1340	-	-		
	-	1.5	1.1811	1.1858	1.1883	1.1427	1.1446	1.1458	1.1451	1.1463	1.1456	1.1468	-	-		
M33	3.5	-	1.2992	1.3103	1.3142	1.2097	1.2108	1.2128	1.2113	1.2133	1.2118	1.2138	1.2123	1.2143		
	-	3	1.2992	1.3088	1.3127	1.2225	1.2235	1.2255	1.2240	1.2260	1.2245	1.2265	1.2250	1.2270		
	-	2	1.2992	1.3056	1.3081	1.2481	1.2495	1.2511	1.2500	1.2516	1.2505	1.2521	-	-		
	-	1.5	1.2992	1.3040	1.3065	1.2609	1.2627	1.2639	1.2632	1.2644	1.2637	1.2649	-	-		



Pipe Tap (Limit)

Nominal Size Inches	Threads per Inch	Projection* Inches	Projection Tolerance + or -	Taper per Foot Limits		Reference Dimensions	
				Min.	Max.	Length (L ₁)	Tap Drill Size** NPT, ANPT, NPTF
				1/16	27	.312	.063
1/8	27	.312	.063	.719	.781	.1615	Q
1/8	18	.459	.063	.719	.781	.2278	7/16
3/8	18	.454	.063	.719	.781	.240	9/16
1/2	14	.579	.063	.719	.781	.320	45/64
3/4	14	.565	.063	.719	.781	.339	29/32
1"	11-1/2	.678	.094	.719	.781	.400	1-9/64
1-1/4	11-1/2	.686	.094	.719	.781	.420	1-31/64
1-1/2	11-1/2	.699	.094	.719	.781	.420	1-23/32
2"	11-1/2	.667	.094	.719	.781	.436	2-3/16
2-1/2	8	.925	.094	.734	.781	.682	2-39/64
3"	8	.925	.094	.734	.781	.766	3-15/64
3-1/2	8	.938	.125	.734	.781	.821	...
4"	8	.950	.125	.734	.781	.844	...

* Distance small end of tap projects through L1 Taper Thread Ring Gage.

** Recommended size given permit direct tapping without reaming the hole, but only give a full thread for approx. the L1 length.

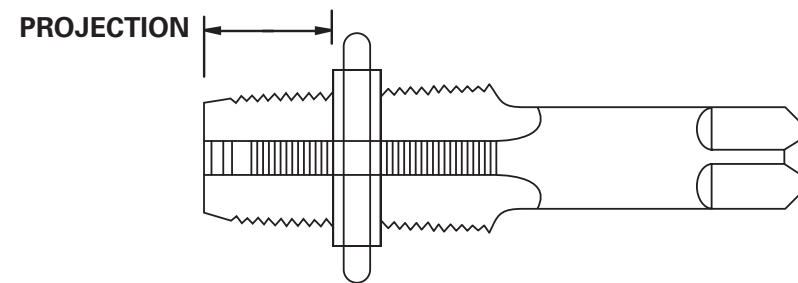

15 TAP DRILL SIZES - UNIFIED THREAD

Size	Threads Per Inch				Minor Diameter			Tap Drill Diameter (Cutting Tap)				
	UNC	UNF	UNEF	UN	Min. 2B&3B	Max. 2B	Max. 3B	80% Thread	75% Thread	70% Thread	65% Thread	60% Thread
#0	-	80	-	-	.0465	.0514	.0514	.0470	.0478	.0486	.0494	.0503
#1	64	-	-	-	.0561	.0623	.0623	.0568	.0578	.0588	.0598	.0608
	-	72	-	-	.0580	.0635	.0635	.0586	.0595	.0604	.0613	.0622
#2	56	-	-	-	.0667	.0737	.0737	.0674	.0686	.0698	.0709	.0721
	-	64	-	-	.0691	.0753	.0753	.0698	.0708	.0718	.0728	.0738
#3	48	-	-	-	.0764	.0845	.0845	.0774	.0787	.0801	.0814	.0828
	-	56	-	-	.0797	.0865	.0865	.0804	.0816	.0828	.0839	.0851
#4	40	-	-	-	.0849	.0939	.0939	.0860	.0876	.0893	.0909	.0925
	-	48	-	-	.0894	.0968	.0968	.0904	.0917	.0931	.0944	.0958
#5	40	-	-	-	.0979	.1062	.1062	.0990	.1006	.1023	.1039	.1055
	-	44	-	-	.1004	.1079	.1079	.1014	.1029	.1043	.1058	.1073
#6	32	-	-	-	.1040	.1140	.1140	.1055	.1076	.1096	.1116	.1136
	-	40	-	-	.1110	.1190	.1186	.1120	.1136	.1153	.1169	.1185
#8	32	-	-	-	.1300	.1390	.1389	.1315	.1336	.1356	.1376	.1396
	-	36	-	-	.1340	.1420	.1416	.1351	.1369	.1387	.1405	.1424
#10	24	-	-	-	.1450	.1560	.1555	.1467	.1494	.1521	.1548	.1575
	-	32	-	-	.1560	.1640	.1641	.1575	.1596	.1616	.1636	.1656
#12	24	-	-	-	.1710	.1810	.1807	.1727	.1754	.1781	.1808	.1835
	-	28	-	-	.1770	.1860	.1857	.1789	.1812	.1835	.1858	.1882
1/4	-	-	32	-	.1820	.1900	.1895	.1835	.1856	.1876	.1896	.1916
	20	-	-	-	.1960	.2070	.2067	.1980	.2013	.2045	.2078	.2110
5/16	-	28	-	-	.2110	.2200	.2190	.2129	.2152	.2175	.2198	.2222
	-	-	32	-	.2160	.2240	.2229	.2175	.2196	.2216	.2236	.2256
3/8	18	-	-	-	.2520	.2650	.2630	.2548	.2584	.2620	.2656	.2692
	-	-	-	20	.2580	.2700	.2680	.2605	.2638	.2670	.2703	.2735
7/16	-	24	-	-	.2670	.2770	.2754	.2692	.2719	.2746	.2773	.2800
	-	-	-	28	.2740	.2820	.2807	.2754	.2777	.2800	.2823	.2847
1/2	-	-	32	-	.2790	.2860	.2847	.2800	.2821	.2841	.2861	.2881
	16	-	-	-	.3070	.3210	.3182	.3101	.3141	.3182	.3222	.3263
9/16	-	-	-	20	.3210	.3320	.3297	.3230	.3263	.3295	.3328	.3360
	-	24	-	-	.3300	.3400	.3372	.3317	.3344	.3371	.3398	.3425
5/8	-	-	32	-	.3360	.3450	.3426	.3379	.3402	.3425	.3448	.3472
	-	-	-	28	.3410	.3490	.3469	.3425	.3446	.3466	.3486	.3506
1 1/8	14	-	-	-	.3600	.3760	.3717	.3633	.3679	.3726	.3772	.3818
	-	-	-	16	.3700	.3840	.3800	.3726	.3766	.3807	.3847	.3888
1 1/4	-	20	-	-	.3830	.3950	.3916	.3855	.3888	.3920	.3953	.3985
	-	-	28	-	.3990	.4070	.4051	.4004	.4027	.4050	.4073	.4097
1 3/8	-	-	-	32	.4040	.4110	.4094	.4050	.4071	.4091	.4111	.4131
	13	-	-	-	.4170	.4340	.4284	.4201	.4251	.4301	.4351	.4400
1 1/2	-	-	-	16	.4320	.4460	.4419	.4351	.4391	.4432	.4472	.4513
	-	20	-	-	.4460	.4570	.4537	.4480	.4513	.4545	.4578	.4610
1 7/8	-	-	28	-	.4610	.4700	.4676	.4629	.4652	.4675	.4698	.4722
	-	-	-	32	.4660	.4740	.4719	.4675	.4696	.4716	.4736	.4756
2	12	-	-	-	.4720	.4900	.4843	.4759	.4813	.4867	.4921	.4976
	-	-	-	16	.4950	.5090	.5040	.4976	.5016	.5057	.5097	.5138
2 1/4	-	18	-	-	.5020	.5150	.5106	.5048	.5084	.5120	.5156	.5192
	-	-	-	20	.5080	.5200	.5162	.5105	.5138	.5170	.5203	.5235
2 3/8	-	-	24	-	.5170	.5270	.5244	.5192	.5219	.5246	.5273	.5300
	-	-	-	28	.5240	.5320	.5301	.5254	.5277	.5300	.5323	.5347
2 1/2	-	-	-	32	.5290	.5360	.5344	.5300	.5321	.5341	.5361	.5381
	11	-	-	-	.5270	.5460	.5391	.5305	.5364	.5423	.5482	.5541



SOLID CARBIDE THREAD MILLS

SOLID CARBIDE THREAD MILLS

COMBO TAPS

COMBO TAPS

SPIRAL FLUTE TAPS

SPIRAL FLUTE TAPS

SPIRAL POINT TAPS

SPIRAL POINT TAPS

STRAIGHT FLUTE TAPS

STRAIGHT FLUTE TAPS

FORMING TAPS

FORMING TAPS

SCREW THREAD INSERT TAPS

SCREW THREAD INSERT TAPS

PIPE TAPS

PIPE TAPS

TECHNICAL DATA

TECHNICAL DATA

Size	Threads Per Inch				Minor Diameter			Tap Drill Diameter (Cutting Tap)				
	UNC	UNF	UNEF	UN	Min. 2B&3B	Max. 2B	Max. 3B	80% Thread	75% Thread	70% Thread	65% Thread	60% Thread
5/8	-	-	-	12	.5350	.5530	.5463	.5384	.5438	.5492	.5546	.5601
	-	-	-	16	.5570	.5710	.5662	.5601	.5641	.5682	.5722	.5763
	-	18	-	-	.5650	.5780	.5730	.5673	.5709	.5745	.5781	.5817
	-	-	-	20	.5710	.5820	.5787	.5730	.5763	.5795	.5828	.5860
	-	-	24	-	.5800	.5900	.5869	.5817	.5844	.5871	.5898	.5925
	-	-	-	28	.5860	.5950	.5926	.5879	.5902	.5925	.5948	.5972
11/16	-	-	-	32	.5910	.5980	.5969	.5925	.5946	.5966	.5986	.6006
	-	-	-	12	.5970	.6150	.6085	.6009	.6063	.6117	.6171	.6226
	-	-	-	16	.6200	.6340	.6284	.6226	.6266	.6307	.6347	.6388
	-	-	-	20	.6330	.6450	.6412	.6355	.6388	.6420	.6453	.6485
	-	-	24	-	.6420	.6520	.6494	.6442	.6469	.6496	.6523	.6550
	-	-	-	28	.6490	.6570	.6551	.6504	.6527	.6550	.6573	.6597
3/4	-	-	-	32	.6540	.6610	.6594	.6550	.6571	.6591	.6611	.6631
	10	-	-	-	.6420	.6630	.6545	.6461	.6526	.6591	.6656	.6721
	-	-	-	12	.6600	.6780	.6707	.6634	.6688	.6742	.6796	.6851
	-	16	-	-	.6820	.6960	.6908	.6851	.6891	.6932	.6972	.7013
	-	-	20	-	.6960	.7070	.7037	.6980	.7013	.7045	.7078	.7110
	-	-	-	28	.7110	.7200	.7176	.7129	.7152	.7175	.7198	.7222
13/16	-	-	-	32	.7160	.7240	.7219	.7175	.7196	.7216	.7236	.7256
	-	-	-	12	.7220	.7400	.7329	.7259	.7313	.7367	.7421	.7476
	-	-	-	16	.7450	.7590	.7533	.7476	.7516	.7557	.7597	.7638
	-	-	20	-	.7580	.7700	.7662	.7605	.7638	.7670	.7703	.7735
	-	-	-	28	.7740	.7820	.7801	.7754	.7777	.7800	.7823	.7847
	-	-	-	32	.7790	.7860	.7844	.7800	.7821	.7841	.7861	.7881
7/8	9	-	-	-	.7550	.7780	.7681	.7595	.7668	.7740	.7812	.7884
	-	-	-	12	.7850	.8030	.7948	.7884	.7938	.7992	.8046	.8101
	-	14	-	-	.7980	.8140	.8068	.8008	.8054	.8101	.8147	.8193
	-	-	-	16	.8070	.8210	.8158	.8101	.8141	.8182	.8222	.8263
	-	-	20	-	.8210	.8320	.8287	.8230	.8263	.8295	.8328	.8360
	-	-	-	28	.8360	.8450	.8426	.8379	.8402	.8425	.8448	.8472
15/16	-	-	-	32	.8410	.8490	.8469	.8425	.8446	.8466	.8486	.8506
	-	-	-	12	.8470	.8650	.8575	.8509	.8563	.8617	.8671	.8726
	-	-	-	16	.8700	.8840	.8783	.8726	.8766	.8807	.8847	.8888
	-	-	20	-	.8830	.8950	.8912	.8855	.8888	.8920	.8953	.8985
	-	-	-	28	.8990	.9070	.9051	.9004	.9027	.9050	.9073	.9097
	-	-	-	32	.9040	.9110	.9094	.9050	.9071	.9091	.9111	.9131
1"	8	-	-	-	.8650	.8900	.8797	.8701	.8782	.8863	.8945	.9026
	-	12	-	-	.9100	.9280	.9198	.9134	.9188	.9242	.9296	.9351
	-	-	-	16	.9320	.9460	.9408	.9351	.9391	.9432	.9472	.9513
	-	-	20	-	.9460	.9570	.9537	.9480	.9513	.9545	.9578	.9610
	-	-	-	28	.9610	.9700	.9676	.9629	.9652	.9675	.9698	.9722
	-	-	-	32	.9660	.9740	.9719	.9675	.9696	.9716	.9736	.9756
1*1/16	-	-	-	8	.9270	.9520	.9422	.9326	.9407	.9488	.9570	.9651
	-	-	-	12	.9720	.9900	.9823	.9759	.9813	.9867	.9921	.9976
	-	-	-	16	.9950	1.0090	1.0033	.9976	1.0016	1.0057	1.0097	1.0138
	-	-	18	-	1.0020	1.0150	1.0105	1.0048	1.0084	1.0120	1.0156	1.0192
	-	-	-	20	1.0080	1.0200	1.0162	1.0105	1.0138	1.0170	1.0203	1.0235
	-	-	-	28	1.0240	1.0320	1.0301	1.0254	1.0277	1.0300	1.0323	1.0347
1*1/8	7	-	-	-	.9700	.9980	.9875	.9765	.9858	.9951	1.0044	1.0137
	-	-	-	8	.9900	1.0150	1.0047	.9951	1.0032	1.0113	1.0195	1.0276
	-	12	-	-	1.0350	1.0530	1.0448	1.0384	1.0438	1.0492	1.0546	1.0601
	-	-	-	16	1.0570	1.0710	1.0658	1.0601	1.0641	1.0682	1.0722	1.0763
	-	-	18	-	1.0650	1.0780	1.0730	1.0673	1.0709	1.0745	1.0781	1.0817
	-	-	-	20	1.0710	1.0820	1.0787	1.0730	1.0763	1.0795	1.0828	1.0860

Size	Threads Per Inch				Minor Diameter			Tap Drill Diameter (Cutting Tap)				
	UNC	UNF	UNEF	UN	Min. 2B&3B	Max. 2B	Max. 3B	80% Thread	75% Thread	70% Thread	65% Thread	60% Thread
1*1/8	-	-	-	28	1.0860	1.0950	1.0926	1.0879	1.0902	1.0925	1.0948	1.0972
1*3/16	-	-	-	8	1.0520	1.0770	1.0672	1.0576	1.0657	1.0738	1.0820	1.0901
	-	-	-	12	1.0970	1.1150	1.1073	1.1009	1.1063	1.1117	1.1171	1.1226
	-	-	-	16	1.1200	1.1340	1.1283	1.1226	1.1266	1.1307	1.1347	1.1388
	-	-	18	-	1.1270	1.1400	1.1355	1.1298	1.1334	1.1370	1.1406	1.1442
	-	-	-	20	1.1330	1.1450	1.1412	1.1355	1.1388	1.1420	1.1453	1.1485
	-	-	-	28	1.1490	1.1570	1.1551	1.1504	1.1527	1.1550	1.1573	1.1597
1*1/4	7	-	-	-	1.0950	1.1230	1.1125	1.1015	1.1108	1.1201	1.1294	1.1387
	-	-	-	8	1.1150	1.1400	1.1297	1.1201	1.1282	1.1363	1.1445	1.1526
	-	12	-	-	1.1600	1.1780	1.1698	1.1634	1.1688	1.1742	1.1796	1.1851
	-	-	-	16	1.1820	1.1960	1.1908	1.1851	1.1891	1.1932	1.1972	1.2013
	-	-	18	-	1.1900	1.2030	1.1980	1.1923	1.1959	1.1995	1.2031	1.2067
	-	-	-	20	1.1960	1.2070	1.2037	1.1980	1.2013	1.2045	1.2078	1.2110
1*5/16	-	-	-	28	1.2110	1.2200	1.2176	1.2129	1.2152	1.2175	1.2198	1.2222
	-	-	-	8	1.1770	1.2020	1.2176	1.1826	1.1907	1.1988	1.2070	1.2151
	-	-	-	12	1.2220	1.2400	1.2323	1.2259	1.2313	1.2367	1.2421	1.2476
	-	-	-	16	1.2450	1.2590	1.2533	1.2476	1.2516	1.2557	1.2597	1.2638
	-	-	18	-	1.2520	1.2650	1.2605	1.2548	1.2584	1.2620	1.2656	1.2692
	-	-	-	20	1.2580	1.2700	1.2662	1.2605	1.2638	1.2670	1.2703	1.2735
1*3/8	-	-	-	28	1.2740	1.2820	1.2801	1.2754	1.2777	1.2800	1.2823	1.2847
	6	-	-	-	1.1950	1.2250	1.2146	1.2018	1.2126	1.2235	1.2343	1.2451
	-	-	-	8	1.2400	1.2650	1.2547	1.2451	1.2532	1.2613	1.2695	1.2776
	-	12	-	-	1.2850	1.3030	1.2948	1.2884	1.2938	1.2992	1.3046	1.3101
	-	-	-	16	1.3070	1.3210	1.3158	1.3101	1.3141	1.3182	1.3222	1.3263
	-	-	18	-	1.3150	1.3280	1.3230	1.3173	1.3209	1.3245	1.3281	1.3317
1*7/16	-	-	-	20	1.3210	1.3320	1.3287	1.3230	1.3263	1.3295	1.3328	1.3360
	-	-	-	28	1.3360	1.3450	1.3426	1.3379	1.3402	1.3425	1.3448	1.3472
	-	-	-	6	1.2570	1.2880	1.2770	1.2643	1.2751	1.2860	1.2968	1.3076
	-	-	-	8	1.3020	1.3270	1.3172	1.3076	1.3157	1.3238	1.3320	1.3401
	-	-	-	12	1.3470	1.3650	1.3573	1.3509	1.3563	1.3617	1.3671	1.3726
	-	-	-	16	1.3700	1.3840	1.3783	1.3726	1.3766	1.3807	1.3847	1.3888
1*1/2	-	-	18	-	1.3770	1.3900	1.3855	1.3798	1.3834	1.3870	1.3906	1.3942
	-	-	-	20	1.3830	1.3950	1.3912	1.3855	1.3888	1.3920	1.3953	1.3985
	-	-	-	28	1.3990	1.4070	1.4051	1.4004	1.4027	1.4050	1.4073	1.4097
	6	-	-	-	1.3200	1.3500	1.3396	1.3268	1.3376	1.3485	1.3593	1.3701
	-	-	-	8	1.3650	1.3900	1.3797	1.3701	1.3782	1.3863	1.3945	1.4026
	-	12	-	-	1.4100	1.4280	1.4198	1.4134	1.4188	1.4242	1.4296	1.4351
1*9/16	-	-	-	16	1.4320	1.4460	1.4408	1.4351	1.4391	1.4432	1.4472	1.4513
	-	-	18	-	1.4400	1.4520	1.4480	1.4423	1.4459	1.4495	1.4531	1.4567
	-	-	-	20	1.4460	1.4570	1.4537	1.4480	1.4513	1.4545	1.4578	1.4610
	-	-	-	28	1.4610	1.4700	1.4676	1.4629	1.4652	1.4675	1.4698	1.4722
	-	-	-	6	1.3820	1.4130	1.4021	1.3893	1.4001	1.4110	1.4218	1.4326
	-	-	-	8	1.4270	1.4520	1.4422	1.4326	1.4407	1.4488	1.4570	1.4651
1*5/8	-	-	-	12	1.4720	1.4900	1.4823	1.4759	1.4813	1.4867	1.4921	1.4976
	-	-	-	16	1.4950	1.5090	1.5033	1.4976	1.5016	1.5057	1.5097	1.5138
	-	-	18	-	1.5020	1.5150	1.5105	1.504				



SOLID CARBIDE THREAD MILLS

COMBO TAPS

SPIRAL FLUTE TAPS

SPIRAL POINT TAPS

STRAIGHT FLUTE TAPS

FORMING TAPS

SCREW THREAD INSERT TAPS

PIPE TAPS

TECHNICAL DATA

Size	Threads Per Inch				Minor Diameter			Tap Drill Diameter (Cutting Tap)				
	UNC	UNF	UNEF	UN	Min. 2B&3B	Max. 2B	Max. 3B	80% Thread	75% Thread	70% Thread	65% Thread	60% Thread
1*11/16	-	-	-	8	1.5520	1.5770	1.5672	1.5576	1.5657	1.5738	1.5820	1.5901
	-	-	-	12	1.5970	1.6150	1.6073	1.6009	1.6063	1.6117	1.6171	1.6226
	-	-	-	16	1.6200	1.6340	1.6283	1.6226	1.6266	1.6307	1.6347	1.6388
	-	-	18	-	1.6270	1.6400	1.6355	1.6298	1.6334	1.6370	1.6406	1.6442
1*3/4	-	-	-	20	1.6330	1.6450	1.6412	1.6355	1.6388	1.6420	1.6453	1.6485
	5	-	-	-	1.5340	1.5680	1.5575	1.5422	1.5552	1.5681	1.5811	1.5941
	-	-	-	6	1.5700	1.6000	1.5896	1.5768	1.5876	1.5985	1.6093	1.6201
	-	-	-	8	1.6150	1.6400	1.6297	1.6201	1.6282	1.6363	1.6445	1.6526
1*13/16	-	-	-	12	1.6600	1.6780	1.6698	1.6634	1.6688	1.6742	1.6796	1.6851
	-	-	-	16	1.6820	1.6960	1.6908	1.6851	1.6891	1.6932	1.6972	1.7013
	-	-	-	20	1.6960	1.7070	1.7037	1.6980	1.7013	1.7045	1.7078	1.7110
	-	-	-	6	1.6320	1.6630	1.6521	1.6393	1.6501	1.6610	1.6718	1.6826
1*7/8	-	-	-	8	1.6770	1.7020	1.6922	1.6826	1.6907	1.6988	1.7070	1.7151
	-	-	-	12	1.7220	1.7400	1.7323	1.7259	1.7313	1.7367	1.7421	1.7476
	-	-	-	16	1.7450	1.7590	1.7533	1.7476	1.7516	1.7557	1.7597	1.7638
	-	-	-	20	1.7580	1.7700	1.7662	1.7605	1.7638	1.7670	1.7703	1.7735
1*15/16	-	-	-	6	1.6950	1.7250	1.7146	1.7018	1.7126	1.7235	1.7343	1.7451
	-	-	-	8	1.7400	1.7650	1.7547	1.7451	1.7532	1.7613	1.7695	1.7776
	-	-	-	12	1.7850	1.8030	1.7948	1.7884	1.7938	1.7992	1.8046	1.8101
	-	-	-	16	1.8070	1.8210	1.8158	1.8101	1.8141	1.8182	1.8222	1.8263
2"	-	-	-	20	1.8210	1.8320	1.8287	1.8230	1.8263	1.8295	1.8328	1.8360
	-	-	-	6	1.7570	1.7880	1.7771	1.7643	1.7751	1.7860	1.7968	1.8076
	-	-	-	8	1.8020	1.8270	1.8172	1.8076	1.8157	1.8238	1.8320	1.8401
	-	-	-	12	1.8470	1.8650	1.8573	1.8509	1.8563	1.8617	1.8671	1.8726
2*1/8	-	-	-	16	1.8700	1.8840	1.8783	1.8726	1.8766	1.8807	1.8847	1.8888
	-	-	-	20	1.8830	1.8950	1.8912	1.8855	1.8888	1.8920	1.8953	1.8985
	4 1/2	-	-	-	1.7590	1.7950	1.7861	1.7691	1.7835	1.7979	1.8124	1.8268
	-	-	-	6	1.8200	1.8500	1.8396	1.8268	1.8376	1.8485	1.8593	1.8701
2*1/4	-	-	-	8	1.8650	1.8900	1.8797	1.8701	1.8782	1.8863	1.8945	1.9026
	-	-	-	12	1.9100	1.9280	1.9198	1.9134	1.9188	1.9242	1.9296	1.9351
	-	-	-	16	1.9320	1.9460	1.9408	1.9351	1.9391	1.9432	1.9472	1.9513
	-	-	-	20	1.9460	1.9570	1.9537	1.9480	1.9513	1.9545	1.9578	1.9610
2*3/8	-	-	-	6	1.9450	1.9750	1.9646	1.9518	1.9626	1.9735	1.9843	1.9951
	-	-	-	8	1.9900	2.0150	2.0047	1.9951	2.0032	2.0113	2.0195	2.0276
	-	-	-	12	2.0350	2.0530	2.0448	2.0384	2.0438	2.0492	2.0546	2.0601
	-	-	-	16	2.0570	2.0710	2.0658	2.0601	2.0641	2.0682	2.0722	2.0763
2*1/2	-	-	-	20	2.0710	2.0820	2.0787	2.0730	2.0763	2.0795	2.0828	2.0860
	4 1/2	-	-	-	2.0090	2.0450	2.0361	2.0191	2.0335	2.0479	2.0624	2.0768
	-	-	-	6	2.0700	2.1000	2.0896	2.0768	2.0876	2.0985	2.1093	2.1201
	-	-	-	8	2.1150	2.1400	2.1297	2.1201	2.1282	2.1363	2.1445	2.1526
2*3/4	-	-	-	12	2.1600	2.1780	2.1698	2.1634	2.1688	2.1742	2.1796	2.1851
	-	-	-	16	2.1820	2.1960	2.1908	2.1851	2.1891	2.1932	2.1972	2.2013
	-	-	-	20	2.1960	2.2070	2.2037	2.1980	2.2013	2.2045	2.2078	2.2110
	-	-	-	6	2.1950	2.2260	2.2146	2.2018	2.2126	2.2235	2.2343	2.2451
2*1/8	-	-	-	8	2.2400	2.2650	2.2547	2.2451	2.2532	2.2613	2.2695	2.2776
	-	-	-	12	2.2850	2.3030	2.2948	2.2884	2.2938	2.2992	2.3046	2.3101
	-	-	-	16	2.3070	2.3210	2.3158	2.3101	2.3141	2.3182	2.3222	2.3263
	-	-	-	20	2.3210	2.3320	2.3287	2.3230	2.3263	2.3295	2.3328	2.3360
2*1/2	4	-	-	-	2.2290	2.2670	2.2594	2.2402	2.2564	2.2727	2.2889	2.3052
	-	-	-	6	2.3200	2.3500	2.3396	2.3268	2.3376	2.3485	2.3593	2.3701
	-	-	-	8	2.3650	2.3900	2.3797	2.3701	2.3782	2.3863	2.3945	2.4026
	-	-	-	12	2.4100	2.4280	2.4198	2.4134	2.4188	2.4242	2.4296	2.4351
2*3/8	-	-	-	16	2.4320	2.4460	2.4408	2.4351	2.4391	2.4432	2.4472	2.4513
	-	-	-	20	2.4460	2.4570	2.4537	2.4480	2.4513	2.4545	2.4578	2.4610

SOLID CARBIDE THREAD MILLS

COMBO TAPS

SPIRAL FLUTE TAPS

SPIRAL POINT TAPS

STRAIGHT FLUTE TAPS

FORMING TAPS

SCREW THREAD INSERT TAPS

PIPE TAPS

TECHNICAL DATA



TAP DRILL SIZES - METRIC THREAD

Size	Pitch		Minor dia.		Tap Drill Diameter									
	M	MF	Min. 6H	Max. 6H	80% Thread		75% Thread		70% Thread		65% Thread		60% Thread	
					mm	Inch	mm	Inch	mm	Inch	mm	Inch	mm	Inch
M1	0.25	-	.729	.798	0.74	.0291	0.76	.0298	0.77	.0304	0.79	.0311	0.81	.0317
	-	0.2	.783	.841	0.79	.0312	0.81	.0317	0.82	.0322	0.83	.0327	0.84	.0332
M1.1	0.25	-	.829	.898	0.84	.0331	0.86	.0337	0.87	.0344	0.89	.0350	0.91	.0356
	-	0.2	.883	.941	0.89	.0351	0.91	.0356	0.92	.0361	0.93	.0367	0.94	.0372
M1.2	0.25	-	.929	.998	0.94	.0370	0.96	.0377	0.97	.0383	0.99	.0389	1.01	.0396
	-	0.2	.983	1.041	0.99	.0391	1.01	.0396	1.02	.0401	1.03	.0406	1.04	.0411
M1.4	0.3	-	1.075	1.159	1.09	.0428	1.11	.0436	1.13	.0444	1.15	.0451	1.17	.0459
	-	0.2	1.183	1.241	1.19	.0469	1.21	.0474	1.22	.0480	1.23	.0485	1.24	.0490
M1.6	0.35	-	1.221	1.321	1.24	.0487	1.26	.0496	1.28	.0505	1.30	.0514	1.33	.0523
	-	0.2	1.383	1.441	1.39	.0548	1.41	.0553	1.42	.0558	1.43	.0563	1.44	.0569
M1.7	0.35	-	1.321	1.421	1.34	.0526	1.36	.0535	1.38	.0544	1.40	.0553	1.43	.0562
	-	0.3	1.375	1.459	1.39	.0547	1.41	.0554	1.43	.0562	1.45	.0570	1.47	.0577
	-	0.25	1.429	1.498	1.44	.0567	1.46	.0573	1.47	.0580	1.49	.0586	1.51	.0593
	-	0.2	1.483	1.541	1.49	.0587	1.51	.0593	1.52	.0598	1.53	.0603	1.54	.0608
M1.8	0.35	-	1.421	1.521	1.44	.0565	1.46	.0574	1.48	.0583	1.50	.0592	1.53	.0601
	-	0.2	1.583	1.641	1.59	.0627	1.61	.0632	1.62	.0637	1.63	.0642	1.64	.0647
M2	0.4	-	1.567	1.679	1.58	.0624	1.61	.0634	1.64	.0644	1.66	.0654	1.69	.0665
	-	0.25	1.729	1.798	1.74	.0685	1.76	.0692	1.77	.0698	1.79	.0704	1.81	.0711
M2.2	0.45	-	1.713	1.838	1.73	.0682	1.76	.0694	1.79	.0705	1.82	.0717	1.85	.0728
	-	0.25	1.929	1.998	1.94	.0764	1.96	.0770	1.97	.0777	1.99	.0783	2.01	.0789
M2.3	0.4	-	1.867	1.979	1.88	.0742	1.91	.0752	1.94	.0762	1.96	.0773	1.99	.0783
	-	0.35	1.921	2.021	1.94	.0762	1.96	.0771	1.98	.0780	2.00	.0789	2.03	.0798
M2.5	0.45	-	2.013	2.138	2.03	.0800	2.06	.0812	2.09	.0823	2.12	.0835	2.15	.0846
	-	0.35	2.121	2.221	2.14	.0841	2.16	.0850	2.18	.0859	2.20	.0868	2.23	.0877
M2.6	0.45	-	2.113	2.238	2.13	.0840	2.16	.0851	2.19	.0863	2.22	.0874	2.25	.0886
	-	0.35	2.221	2.321	2.24	.0880	2.26	.0889	2.28	.0898	2.30	.0907	2.33	.0916
M3	0.5	-	2.459	2.599	2.48	.0977	2.51	.0989	2.55	.1002	2.58	.1015	2.61	.1028
	-	0.35	2.621	2.721	2.64	.1038	2.66	.1047	2.68	.1056	2.70	.1065	2.73	.1074
M3.5	0.6	-	2.850	3.010	2.88	.1132	2.92	.1148	2.95	.1163	2.99	.1178	3.03	.1194
	-	0.35	3.121	3.221	3.14	.1235	3.16	.1244	3.18	.1253	3.20	.1262	3.23	.1271
M4	0.7	-	3.242	3.422	3.27	.1288	3.32	.1306	3.36	.1324	3.41	.1342	3.45	.1360
	-	0.5	3.459	3.599	3.48	.1370	3.51	.1383	3.55	.1396	3.58	.1409	3.61	.1421
M4.5	0.75	-	3.688	3.878	3.72	.1465								



TAP DRILL SIZES - UNIFIED THREAD / FORMING TAPS

Size	Threads Per Inch			Minor Diameter			Tap Drill Diameter (Cutting Tap)				
	UNC	UNF	UNEF	Min. 2B&3B	Max. 2B	Max. 3B	75% Thread	70% Thread	65% Thread	60% Thread	55% Thread
#0	-	80	-	.0465	.0514	.0514	.0536	.0541	.0545	.0549	.0553
	64	-	-	.0561	.0623	.0623	.0650	.0656	.0661	.0666	.0672
#1	-	72	-	.0580	.0635	.0635	.0659	.0664	.0669	.0673	.0678
	56	-	-	.0667	.0737	.0737	.0769	.0775	.0781	.0787	.0793
#2	-	64	-	.0691	.0753	.0753	.0780	.0786	.0791	.0796	.0802
	48	-	-	.0764	.0845	.0845	.0884	.0891	.0898	.0905	.0912
#3	-	56	-	.0797	.0865	.0865	.0899	.0905	.0911	.0917	.0923
	40	-	-	.0849	.0939	.0939	.0993	.1001	.1010	.1018	.1027
#4	-	48	-	.0894	.0968	.0968	.1014	.1021	.1028	.1035	.1042
	40	-	-	.0979	.1062	.1062	.1123	.1131	.1140	.1148	.1157
#5	-	44	-	.1004	.1079	.1079	.1134	.1142	.1150	.1157	.1165
	32	-	-	.1040	.1140	.1140	.1221	.1231	.1242	.1253	.1263
#6	-	40	-	.1110	.1190	.1186	.1253	.1261	.1270	.1278	.1287
	32	-	-	.1300	.1390	.1389	.1481	.1491	.1502	.1513	.1523
#8	-	36	-	.1340	.1420	.1416	.1498	.1508	.1517	.1527	.1536
	24	-	-	.1450	.1560	.1555	.1688	.1702	.1716	.1730	.1744
#10	-	32	-	.1560	.1640	.1641	.1741	.1751	.1762	.1773	.1783
	24	-	-	.1710	.1810	.1807	.1948	.1962	.1976	.1990	.2004
#12	-	28	-	.1770	.1860	.1857	.1978	.1990	.2002	.2014	.2026
	-	-	32	.1820	.1900	.1895	.2001	.2011	.2022	.2033	.2043
1/4	20	-	-	.1960	.2070	.2067	.2245	.2262	.2279	.2296	.2313
	-	28	-	.2110	.2200	.2190	.2318	.2330	.2342	.2354	.2366
5/16	-	-	32	.2160	.2240	.2229	.2341	.2351	.2362	.2373	.2383
	18	-	-	.2520	.2650	.2630	.2842	.2861	.2879	.2898	.2917
3/8	-	24	-	.2670	.2770	.2754	.2913	.2927	.2941	.2955	.2969
	-	-	-	.2740	.2820	.2807	.2943	.2955	.2967	.2979	.2991
7/16	-	-	32	.2790	.2860	.2847	.2966	.2976	.2987	.2998	.3008
	16	-	-	.3070	.3210	.3182	.3431	.3453	.3474	.3495	.3516
1/2	-	24	-	.3300	.3400	.3372	.3538	.3552	.3566	.3580	.3594
	-	-	-	.3360	.3450	.3426	.3568	.3580	.3592	.3604	.3616
9/16	-	-	32	.3410	.3490	.3469	.3591	.3601	.3612	.3623	.3633
	14	-	-	.3600	.3760	.3717	.4011	.4035	.4059	.4084	.4108
5/8	-	20	-	.3830	.3950	.3916	.4120	.4137	.4154	.4171	.4188
	-	-	28	.3990	.4070	.4051	.4193	.4205	.4217	.4229	.4241
3/4	13	-	-	.4170	.4340	.4284	.4608	.4634	.4660	.4686	.4712
	-	20	-	.4460	.4570	.4537	.4745	.4762	.4779	.4796	.4813
1	-	-	28	.4610	.4700	.4676	.4818	.4830	.4842	.4854	.4866
	12	-	-	.4720	.4900	.4843	.5200	.5228	.5257	.5285	.5313
1 1/8	-	18	-	.5020	.5150	.5106	.5342	.5361	.5379	.5398	.5417
	-	-	24	.5170	.5270	.5244	.5413	.5427	.5441	.5455	.5469
1 1/4	11	-	-	.5270	.5460	.5391	.5786	.5817	.5848	.5879	.5910
	-	-	-	.5570	.5710	.5662	.5931	.5953	.5974	.5995	.6016
1 3/8	-	18	-	.5650	.5780	.5730	.5967	.5986	.6004	.6023	.6042
	-	-	24	.5800	.5900	.5869	.6038	.6052	.6066	.6080	.6094
1 1/2	10	-	-	.6420	.6630	.6545	.6990	.7024	.7058	.7092	.7126
	-	16	-	.6820	.6960	.6908	.7181	.7203	.7224	.7245	.7266
1 3/4	-	-	20	.6960	.7070	.7037	.7245	.7262	.7279	.7296	.7313



Size	Threads Per Inch			Minor Diameter			Tap Drill Diameter (Cutting Tap)				
	UNC	UNF	UNEF	Min. 2B&3B	Max. 2B	Max. 3B	75% Thread	70% Thread	65% Thread	60% Thread	55% Thread
7/8	9	-	-	.7550	.7780	.7681	.8183	.8221	.8259	.8297	.8334
	-	14	-	.7980	.8140	.8068	.8386	.8410	.8434	.8459	.8483
1"	-	-	20	.8210	.8320	.8287	.8495	.8512	.8529	.8546	.8563
	8	-	-	.8650	.8900	.8797	.9363	.9405	.9448	.9490	.9533
1 1/8	-	12	-	.9100	.9280	.9198	.9575	.9603	.9632	.9660	.9688
	-	-	20	.9460	.9570	.9537	.9745	.9762	.9779	.9796	.9813
1 1/4	7	-	-	.9700	.9980	.9875	1.0521	1.0570	1.0619	1.0667	1.0716
	-	12	-	1.0350	1.0530	1.0448	1.0825	1.0853	1.0882	1.0910	1.0938
1 3/4	-	-	18	1.0650	1.0780	1.0730	1.0967	1.0986	1.1004	1.1023	1.1042
	7	-	-	1.0950	1.1230	1.1125	1.1771	1.1820	1.1869	1.1917	1.1966
2"	-	12	-	1.1600	1.1780	1.1698	1.2075	1.2103	1.2132	1.2160	1.2188
	-	-	18	1.1900	1.2030	1.1980	1.2217	1.2236	1.2254	1.2273	1.2292



19 TAP DRILL SIZES - METRIC THREAD / FORMING TAPS

Metric	Size	RECOMMENDATION		Unified	Size	RECOMMENDATION	
		Drill Size				Drill Size	
		Inch	metric (mm)			Inch	metric (mm)
M2 x 0.4		.0827	2.10	#2 - 56 UNC		.0906	2.30
M2.2 x 0.45		.0906	2.30	#3 - 48 UNC		.1063	2.70
M2.5 x 0.45		.1024	2.60	#3 - 56 UNF		.1043	2.65
M3 x 0.5		.1240	3.15	#4 - 40 UNC		.1181	3.00
M3.5 x 0.6		.1457	3.70	#4 - 48 UNF		.1181	3.00
M4 x 0.7		.1654	4.20	#5 - 40 UNC		.1339	3.40
M5 x 0.8		.2047	5.20	#5 - 44 UNF		.1299	3.30
M6 x 1.0		.2480	6.30	#6 - 32 UNC		.1457	3.70
M7 x 1.0		.2874	7.30	#6 - 40 UNF		.1457	3.70
M8 x 1.0		.3268	8.30	#8 - 32 UNC		.1732	4.40
M8 x 1.25		.3307	8.40	#8 - 36 UNF		.1732	4.40
M9 x 1.25		.3701	9.40	#10 - 24 UNC		.2008	5.10
M10 x 1.25		.4094	10.40	#10 - 32 UNF		.2008	5.10
M10 x 1.5		.4134	10.50	#12 - 24 UNC		.2283	5.80
M11 x 1.5		.4528	11.50	1/4 - 20 UNC		.2638	6.70
M12 x 1.25		.4882	12.40	1/4 - 28 UNF		.2598	6.60
M12 x 1.5		.4921	12.50	5/16 - 18 UNC		.3307	8.40
M12 x 1.75		.4921	12.50	5/16 - 24 UNF		.3228	8.20
M14 x 1.5		.5709	14.50	3/8 - 16 UNC		.3937	10.00
M14 x 2.0		.5709	14.50	3/8 - 24 UNF		.3858	9.80
M16 x 1.5		.6496	16.50	7/16 - 14 UNC		.4528	11.50
M16 x 2.0		.6496	16.50	7/16 - 20 UNF		.4528	11.50
M18 x .5		.7283	18.50	1/2 - 13 UNC		.5236	13.30
M18 x 2.0		.7283	18.50	1/2 - 20 UNF		.5157	13.10
M18 x 2.5		.7382	18.75	9/16 - 12 UNC		.5866	14.90
M20 x 1.5		.8071	20.50	9/16 - 18 UNF		.5787	14.70
M20 x 2.0		.8071	20.50	5/8 - 11 UNC		.6496	16.50
M20 x 2.5		.8169	20.75	5/8 - 18 UNF		.6417	16.30
M22 x 1.5		.8858	22.50	3/4 - 10 UNC		.7795	19.80
M22 x 2.0		.8858	22.50	3/4 - 16 UNF		.7677	19.50
M22 x 2.5		.8957	22.75	7/8 - 9 UNC		.9055	23.00
M24 x 2.0		.9646	24.50	7/8 - 14 UNF		.8858	22.50
M24 x 3.0		.9843	25.00	1 - 8 UNC		1.0433	26.50
M27 x 3.0		1.1024	28.00	1 - 12 UNF		1.0236	26.00
M30 x 3.5		1.2205	31.00	1-1/8 - 7 UNC		1.1713	29.75
				1-1/8 - 8 UN		1.1417	29.00
				1-1/8 - 12 UNF		1.1516	29.25
				1-1/4 - 7 UNC		1.2992	33.00
				1-1/4 - 8 UN		1.2795	32.50
				1-1/4 - 12 UNF		1.2795	32.50
				1-3/8 - 6 UNC		1.4173	36.00
				1-3/8 - 8 UN		1.3976	35.50
				1-3/8 - 12 UNF		1.4173	36.00
				1-1/2 - 6 UNC		1.5354	39.00
				1-1/2 - 8 UN		1.5354	39.00
				1-1/2 - 12 UNF		1.5354	39.00

20 CONVERSION TABLE

SURFACE FEET PER MINUTE TO REVOLUTIONS PER MINUTE

Surface Feet Per Minute	20	25	30	40	50	60	70	80	90	100	110	120	130	140	150
Tap Size	Revolutions Per Minute														
0	1273	1592	1910	2546	3183	3820	4456	5093	5730	6366	7003	7639	8276	8913	9549
1	1047	1308	1570	2093	2617	3140	3663	4186	4710	5233	5756	6279	6808	7326	7849
2	888	1110	1333	1777	2221	2665	3109	3554	3999	4422	4886	5330	5774	6218	6662
3	772	964	1157	1543	1929	2315	2701	3086	3472	3858	4244	4629	5015	5401	5787
4	682	853	1023	1364	1705	2046	2387	2728	3069	3411	3751	4092	4434	4775	5116
5	611	764	917	1222	1528	1833	2139	2445	2750	3056	3361	3667	3973	4278	4584
6	553	691	829	1106	1382	1658	1934	2211	2487	2764	3040	3316	3592	3869	4145
8	466	583	699	932	1165	1398	1631	1864	2097	2330	2563	2796	3029	3262	3495
10	402	502	603	804	1005	1205	1406	1607	1808	2009	2210	2411	2612	2813	3014
12	354	442	531	707	884	1061	1238	1415	1592	1769	1945	2122	2300	2476	2653
1/4	306	382	458	611	764	917	1070	1222	1375	1528	1681	1833	1986	2139	2292
5/16	245	306	367	486	611	733	856	978	1100	1222	1345	1467	1589	1711	1833
3/8	204	255	306	407	509	611	713	815	917	1019	1120	1222	1324	1426	1528
7/16	175	219	262	349	437	524	611	698	786	873	960	1048	1135	1222	1310
1/2	153	191	229	306	382	458	535	611	688	764	840	917	993	1070	1146
9/16	137	172	206	275	344	412	481	550	619	687	756	825	893	963	1031
5/8	122	153	183	244	306	367	428	489	550	611	672	733	794	856	917
3/4	102	128	153	203	255	306	357	407	458	509	560	611	662	713	764
7/8	87	109	131	175	218	252	306	350	392	437	480	524	568	611	655
1	76	96	115	153	191	230	268	306	344	382	420	458	497	535	573

TROUBLE SHOOTING GUIDE

Specific Problem	Cause	Solution
Dimensional Accuracy		
Upsize Pitch Diameter	Tap	<ol style="list-style-type: none"> Use proper limits of taps Use longer chamfered taps
	Chip Packing	<ol style="list-style-type: none"> Use spiral point or spiral fluted taps Reduce number of flutes to provide extra chip room Use larger hole size If tapping a hole, allow deeper hole where applicable or shorten the thread length of the parts Use proper lubricant
	Galling	<ol style="list-style-type: none"> Apply proper surface treatment such as Hardslick or chrome Use proper cutting lubricant Reduce tapping speed Use proper cutting angle in accordance with material being tapped Use large hole size
	Operating Conditions	<ol style="list-style-type: none"> Apply proper tapping speed Correct alignment of tap and drill hole Free cutting either tap or workpiece Use proper tapping speed to avoid torn or rough threads Use lead screw tapper Use proper tapping machine with suitable power Avoid misalignment of the tap and drill hole from loose spindle or worn holder
	Tool Condition	<ol style="list-style-type: none"> Obtain proper indexing angle for the flutes at the cutting edge Grind proper cutting angle and chamfer angle Avoid too narrow a land width Remove burrs from regrinding
	Upsize Internal Diameter	Hole Size
	Galling	1. Galling solutions 1 through 4 above can be applied to this specific problem
Undersize Pitch Diameter	Incorrect Tap	<ol style="list-style-type: none"> Use oversize taps Apply proper chamfer angle Increase cutting angle
	Damaged Thread	1. Use proper reversing speed to avoid damaging tapped thread on the way out of the hole
	Left-over Chips	<ol style="list-style-type: none"> Increase cutting performance to avoid any left over chips in the hole Remove left over chips from the hole for gage checking
Undersize Internal Diameter	Hole Size	1. Use maximum drill size

Specific Problem	Cause	Solution
Tool Life		
Breakage	Incorrect Tap Selection	<ol style="list-style-type: none"> Avoid chip packing in the flutes or the bottom of the hole. Use spiral pointed or spiral fluted taps or fluteless taps. Apply correct surface treatment such as Hardslick or bright
	Excessive Tapping Torque	<ol style="list-style-type: none"> Use larger drill size Try to shorten thread length Increase cutting angle Apply a tap with more thread relief and reduced land width Apply correct surface treatment such as Hardslick
	Operating Conditions	<ol style="list-style-type: none"> Reduce tapping speed Avoid misalignment between tap and the hole and tapered hole Use floating type of tapping holder Use tapping holder with torque adjustment Avoid hitting bottom of the hole with tap
	Tool Condition	<ol style="list-style-type: none"> Do not grind the bottom of the flute Avoid too narrow a land width Remove all worn sections when regrinding the flutes Regrind tool more frequently
Chipping	Incorrect Tap Selection	<ol style="list-style-type: none"> Reduce cutting angle Use a different kind of high-speed steel tap Reduce hardness of the tap Increase chamfer length Avoid chip packing in the flutes or in the bottom of the hole by using spiral fluted or spiral pointed taps
	Wear	<ol style="list-style-type: none"> Reduce tapping speed Avoid misalignment between tap and hole Avoid sudden return of reverse in blind hole tapping Avoid galling Use larger hole size
Wear	Incorrect Tap Selection	<ol style="list-style-type: none"> Apply specially designed tap for tapping heat treated material Change to a type of high-speed steel tap that contains vanadium Apply special surface treatment such as TiCN or Hardslick Increase chamfer length
	Operating Conditions	<ol style="list-style-type: none"> Reduce tapping speed Apply proper cutting lubricants Avoid work hardened hole Use larger hole size
	Tool Condition	<ol style="list-style-type: none"> Grind proper cutting angle Avoid hardness reduction from grinding process
Torn or Rough Thread	Chamfer Too Short	1. Increase chamfer length
	Wrong Cutting Angle	1. Apply proper cutting angle

Specific Problem	Cause	Solution
Surface Finish		
Tom or Rough Thread	Galling	<ol style="list-style-type: none"> 1. Use thread relieved taps 2. Reduce land width 3. Apply surface treatment such as Hardslick or chrome 4. Use proper cutting lubricant 5. Reduce tapping speed 6. Use larger hole size 7. Obtain proper alignment between tap and work
	Chip Packing	<ol style="list-style-type: none"> 1. Use spiral pointed or spiral fluted taps 2. Use larger drill size
Chattering on Tapped Thread	Tool Free Cutting	<ol style="list-style-type: none"> 1. Reduce cutting angle 2. Reduce amount of thread relief
	Tool Condition	<ol style="list-style-type: none"> 1. Do not grind the bottom of the flute 2. Avoid too narrow a land width

EDP No. INDEX

EDP No.	Page	EDP No.	Page	EDP No.	Page
B0	80	G9	77	N8	108
B1	80	H0	77	O1	106
B2	80	H2	78	O3	110
B3	75	H4	78	O5	109
B5	75	H5	73	O9	119
BB	68	H7	73	Q0	187
BD	72	H8	73	Q1	187
BF	71	I0	116	Q6	187
BG	79	I2	116	Q9	188
BG-GB	79	I3	113	R0	188
BH	70	I5	113	R1	188
BI	68	I9	130	R7	189
BK	71	IA	119	R8	189
BM	70	IB	125	R9	189
BO	72	IC	125	S0	189
BS	83	J0	130	S1	190
BT	83	J1	130	S2	190
BU	88	J2	116	SI	177, 180
BV	88	J3	121	ST	177, 180
BW	92	J6	113	T0C01	147
BX	92	J7	130	T1-C	49
C0	91	J8	121	T1-S	49
C2	93	J9	127	T2	41
C3	93	K2	127	T2496	128
C4	93	K3	120	T2-C	41
D2	80	K5	120	T2K01	129
D3	85	K6	120	T2-S	41
D6	75	K7	127	T3	56
D8	91	K9	131	T3-C	56
D9	93	L0	131	T3-S	56
E0	85	L1	131	T4	54
E2	90	L3	133	T4-C	54
E4	90	L4	133	T4-S	54
E5	90	L5	133	T5	43
E6	84	L7	132	T5-C	43
E8	84	L8	132	T5-S	43
E9	84	L9	132	T6	44
F4	94	M2	115	T6216	134
F6	94	M3	115	T6217	140
F8	94	M4	111	T6226	141
G0	97	M6	111	T6236	143
G1	97	M7	111	T6256	138
G2	97	M9	106	T6295	99
G4	96	N3	110	T6315	158
G5	96	N4	109	T6316	152
G6	96	N7	108	T6505	192

EDP No. **INDEX**

EDP No.	Page	EDP No.	Page	EDP No.	Page
T6536	191	T7R02	174	THR02	174
T6616	163	T8	45	TK808	112
T6A85	100	T8216	134	TK858	74
T6A86	100	T8217	140	TK-C	60
T6A96	99	T8226	141	TKR03	167
T6B17	142	T8236	143	TK-S	60
T6C16	134	T8295	99	TQ808	112
T6G36	143	T8315	158	TQ858	74
T6L36	191	T8316	152	TR	148
T6-N	44	T8546	193	TR808	112
T7	46	T8616	163	TR858	74
T7216	134	T8A85	100	TR-A	150
T7217	140	T8A86	100	TR-R	150
T7226	141	T8A96	99	Z0	169
T7236	143	T8B17	142	Z1	169
T7256	138	T8C16	134	Z2	169
T7295	99	T8D01	101	Z3	169
T7315	158	T8D02	101	Z4	171
T7316	152	T8G36	143	Z5	171
T7326	159	T8-N	45	Z6	171
T7336	161	T8R01	174	Z7	171
T7405	184	T8R02	174	Z8	173
T7406	178	T9	48	Z9	173
T7415	182	T9-C	48	ZA	173
T7425	179	TA-C	50	ZB	173
T7426	183	TA-S	50	ZC	173
T7436	181	TB	57	ZD	173
T7505	192	TB-N	57	ZF	168
T7536	191	TCA-S/C	51		
T7546	193	TCB-S/C	51		
T7616	163	TC-C	59		
T7A15	162	TCC-S/C	53		
T7A16	152	TCD-S/C	53		
T7A85	100	TCE-S/C	61		
T7A86	100	TCF-S/C	61		
T7A96	99	TCG-S/C	63		
T7B15	160	TCH-S/C	63		
T7B16	152	TC-S	59		
T7B17	142	TD	34		
T7-C	46	TE	33		
T7C16	134	TF	35		
T7D01	101	TG	35		
T7D02	101	TH	58		
T7G36	143	TH505	192		
T7L36	191	TH-N	58		
T7R01	174	THR01	174		

Best Quality and Punctual Delivery For world-wide Customers

Thanks to our quality reliability and developing technics, YG-1 has been expanding the market share and growing with partners since 1982. As one of the leading cutting tool manufacturer, we are aiming at having customers experience YG-1's various cutting tool solution all around the world. In order to achieve most efficient logistics, production and marketing, YG-1 has established a global network over 75 countries and international logistics center. This gives the opportunity to provide the best service and satisfy our customer's requirement at all time.



GLOBAL COMPANY



YG-1 TOOL(U.S.A)
PHONE : +1 800 765 8665
FAX : +1 866 941 8665
E-mail : heatherlee@yg1usa.com



YG-1 LATIN AMERICA(BRAZIL)
PHONE : +55 11 4496 2170
FAX : +55 11 4591 1438
E-mail : walter.campos@yg1.com.br



YG-1 CANADA INC.(CANADA)
PHONE : +1 905 335 2500
FAX : +1 905 335 4003
E-mail : reception@yg1.ca



YG-1 TOOLS MEXICO SA DE CV(MEXICO)
PHONE : +52 55 5576 8798
FAX : +52 55 5576 8790
E-mail : khmin@yg1.kr



NEW CENTURY TOOL CO., LTD.(CHINA)
PHONE : +86 532 8676 9779
FAX : +86 532 8676 9105
E-mail : qnct@qnct.cn



QINGDAO YG-1 TOOL CO.,LTD.(CHINA)
PHONE : +86 532 8519 7366
FAX : +86 532 8519 7959
E-mail : qyg1@qyg1.com



YG-1 HONG KONG LTD.(HONG KONG)
PHONE : +852 2439 9018
FAX : +852 2439 9020
E-mail : enquiry@yghk.com.hk



YG CUTTING TOOL CORP. PVT. LTD.(INDIA)
PHONE : +91 80 4354 3600
FAX : +91 80 4354 3613
E-mail : marketing@yg1india.com



YG-1 INDUSTRIES INDIA PVT.LTD.(INDIA)
PHONE : +91 22 2580 6241
FAX : +91 22 2580 3576
E-mail : thanesales@yg1india.com



PT.YGI TOOLS (INDONESIA)
PHONE : +62 21 4585 8141
FAX : +62 21 4587 7412
E-mail : yg1tools@gmail.com



YG-1 JAPAN CO., LTD.(JAPAN)
PHONE : +81 6 6305 9897
FAX : +81 6 6305 9898
E-mail : toyokazu-kitaoka@yg1.jp



YG-1 MALAYSIA SDN. BHD.(MALAYSIA)
PHONE : +603 5569 4834
FAX : +603 5569 4814
E-mail : enquiries@yg-1.com.my



YG-1 THAILAND CO., LTD.(THAILAND)
PHONE : +662 732 0186-7
FAX : +662 732 0188
E-mail : info@yg1.co.th



YG-1 VIETNAM CO., LTD.
PHONE : +84 4 3795 7233
FAX : +84 4 3795 7232
E-mail : yg1vietnam@yg1.co.kr



YG-1 AUSTRALIA PTY. LTD.(AUSTRALIA)
PHONE : +61 3 9558 0177
FAX : +61 3 9558 2778
E-mail : ygone@yg1.kr



YG-1 EUROPE(FRANCE)
PHONE : +33 172 84 4070
FAX : +33 172 84 4086
E-mail : yg1@yg1.eu



YG-1 DEUTSCHLAND GmbH(GERMANY)
PHONE : +49 6173 9667 0
FAX : +49 6173 9667 29
E-mail : info@yg-1.de



YG-1 POLAND Sp. z o.o.(POLAND)
PHONE : +48 22 622 2586
FAX : +48 22 622 2587
E-mail : info@yg-1.pl



YG-1 CO., TRADING SRL(ROMANIA)
PHONE : +40 21 25 25 501-3
FAX : +40 21 25 25 506
E-mail : kimromko@yg1.kr



TEKNO TAKIM San. Tic. AS.(TURKEY)
PHONE : +90 212 671 1590
FAX : +90 212 671 1595
E-mail : info@teknoktakim.com

Challenge toward a Global Leader-
YG-1 Leads the World Market.



TECHNICAL DATA

PIPE TAPS

SCREW THREAD INSERT TAPS

FORMING TAPS

STRAIGHT FLUTE TAPS

SPIRAL POINT TAPS

SPIRAL FLUTE TAPS

COMBO TAPS

SOLID CARBIDE THREAD MILL

YG **YG-1 CO., LTD.**

YG-1 Korea

211, Sewolcheon-ro, Bupyeong-gu, Incheon, Korea

PHONE: +82-32-526-0909, FAX: +82-32-526-4373

<http://www.yg1.kr>

E-mail: yg1@yg1.kr

YG-1 USA

730 Corporate Woods Parkway Vernon Hills, IL 60061 U.S.A

PHONE: 800-765-8665, FAX: 866-941-8665

Technical Assistance: 888-868-5988

<http://www.yg1usa.com>

Tool specifications are subject to change without prior notice.