

GENERAL INFORMATION

AC100+ GOLD®

Vinylester Injection Adhesive Anchoring System

PRODUCT DESCRIPTION

The AC100+ Gold is a two-component vinylester adhesive anchoring system. The system includes injection adhesive in plastic cartridges, mixing nozzles, dispensing tools and hole cleaning equipment. The adhesive is designed for bonding threaded rod and reinforcing bar elements into drilled holes in concrete and masonry base materials. It can be considered for use in solid base materials as well as hollow base materials with screen tubes.

GENERAL APPLICATIONS AND USES

- Bonding threaded rod and reinforcing bar into hardened concrete and masonry
- Evaluated for use in dry and water-saturated concrete (including water filled holes)
- Suitable to resist loads in cracked or uncracked concrete base materials
- Adhesive system can be installed in a wide range of base material temperatures; qualified for structural applications in concrete and masonry as low as 14°F (-10°C)
- Qualified for seismic (earthquake) and wind loading

FEATURES AND BENEFITS

- + Designed for use with threaded rod and reinforcing bar hardware elements
- + Consistent performance in low and high strength concrete
- + Evaluated and recognized for freeze/thaw performance (interior and exterior applications)
- + Evaluated and recognized for a range of embedments
- + Versatile low odor formula with optimized cure time
- + Evaluated and recognized for long term and short term loading (see performance tables)
- + Mixing nozzles proportion adhesive and provide simple delivery method into drilled holes
- + Cartridge design allows for multiple uses using extra mixing nozzles
- + Universal product for concrete and masonry (hollow and solid base materials)

APPROVALS AND LISTINGS

- International Code Council, Evaluation Service (ICC-ES) ESR-2582 for concrete
- International Code Council, Evaluation Service (ICC-ES) ESR-3200 for masonry
- International Code Council, Evaluation Service (ICC-ES) ESR-4105 for Unreinforced Masonry (URM)
- Code compliant with the 2018 IBC/IRC, 2015 IBC/IRC, 2012 IBC/IRC, and 2009 IBC/IRC
- Tested in accordance with ASTM E488 / ACI 355.4 and ICC-ES AC308 for use in structural concrete with ACI 318-14 Chapter 17 and ACI 318-11/08 Appendix D
- Compliant with NSF/ANSI Standard 61 for drinking water system components – health effects; meets requirements for materials in contact with potable water and water treatment
- Conforms to requirements of ASTM C 881 and AASHTO M235, Types I, II, IV and V, Grade 3, Classes A & B (meets Type III with exception of elongation)
- Department of Transportation listings – see www.DEWALT.com or contact transportation agency

GUIDE SPECIFICATIONS

CSI Divisions: 03 16 00 - Concrete Anchors, 04 05 19.16 - Masonry Anchors and 05 05 19 - Post-Installed Concrete Anchors. Adhesive anchoring system shall be AC100+ Gold as supplied by DEWALT, Towson, MD. Anchors shall be installed in accordance with published instructions and requirements of the Authority Having Jurisdiction.



SECTION CONTENTS

General Information..... 1
 Reference Data (ASD)..... 2
 Strength Design (SD)..... 10
 Installation Instructions (Solid Base Materials)..... 20
 Installation Instructions (Unreinforced Masonry [URM Walls] and Hollow Base Materials)..... 21
 Reference Tables for Installation..... 22
 Ordering Information..... 23



AC100+ GOLD

PACKAGING (10:1 MIX RATIO)

Coaxial Cartridge

- 9.5 fl. oz. (280 ml or 17.1 in³)

Dual Cartridge, side-by-side

- 11.5 fl. oz. (345 ml or 21.0 in³)
- 28 fl. oz. (825 ml or 50.3 in³)

STORAGE LIFE & CONDITIONS

Eighteen months in a dry, dark environment with temperature ranging from 32°F and 86°F (-0°C to 30°C)

ANCHOR SIZE RANGE (TYPICAL)

- 3/8" to 1-1/4" diameter rod
- No. 3 to No. 10 rebar

SUITABLE BASE MATERIALS

- Normal-weight concrete
- Lightweight concrete
- Grouted concrete masonry (CMU)
- Hollow concrete masonry (CMU)
- Hollow core concrete
- Brick masonry
- Unreinforced Masonry (URM Walls)

PERMISSIBLE INSTALLATION CONDITIONS (ADHESIVE)

- Dry concrete
- Water-saturated concrete (wet)
- Water-filled holes (flooded)

REFERENCE DATA (ASD)

Allowable Stress Design (ASD) Installation Table for AC100+ Gold (Solid Concrete Base Materials)

Dimension/Property		Notation	Units	Nominal Anchor Size								
Nominal threaded rod size		-	in.	3/8	1/2	5/8	3/4	7/8	1	-	1-1/4	-
Carbide drill bit nominal size (ANSI) for threaded rod		d_{bit}	in.	7/16	9/16	11/16 or 3/4	7/8	1	1-1/8	-	1-3/8	-
Reinforcing bar size		-	No.	3	4	5	6	7	8	9	-	10
Carbide drill bit nominal size (ANSI) for rebar		d_{bit}	in.	7/16	5/8	3/4	7/8	1	1-1/8	1-1/4	1-3/8	1-1/2
Nominal anchor/rebar diameter		d	in. (mm)	0.375 (9.5)	0.500 (12.7)	0.625 (15.9)	0.750 (19.1)	0.875 (22.2)	1.000 (25.4)	1.125 (28.6)	1.250 (31.8)	1.250 (31.8)
Minimum nominal embedment depth		$h_{nom,min}$	in. (mm)	2-3/8 (61)	2-3/4 (70)	3-1/8 (79)	3-1/2 (89)	3-1/2 (89)	4 (102)	4-1/2 (114)	5 (127)	5 (127)
Maximum torque (only possible after full cure time of adhesive)	A36 or F1554 Grade 36 carbon steel rod	T_{max}	ft.-lb. (N-m)	10 (13)	25 (34)	50 (68)	90 (122)	125 (169)	165 (224)	-	280 (379)	-
	F593 Condition CW stainless steel rod or ASTM A193, Grade B7 carbon steel rod	T_{max}	ft.-lb. (N-m)	16 (22)	33 (45)	60 (81)	105 (142)	125 (169)	165 (224)	-	280 (379)	-

1. The listed drill bit sizes are also applicable to installations into grouted concrete masonry.

Allowable Stress Design (ASD) Installation Table for AC100+ Gold (Hollow Base Material with Screen Tube)

Dimension/Property		Notation	Units	Nominal Size - Stainless Steel					Nominal Size - Plastic				
Nominal threaded rod size		-	in.	1/4	3/8	1/2	5/8	3/4	-	1/4	3/8	1/2	5/8
Nominal anchor diameter		d	in. (mm)	0.250 (6.4)	0.375 (9.5)	0.500 (12.7)	0.625 (15.9)	0.750 (19.1)	-	0.250 (6.4)	0.375 (9.5)	0.500 (12.7)	0.625 (15.9)
Reinforcing bar size		-	No.	-	-	3	4	5	6	-	-	-	-
Nominal rebar diameter		d	in.	-	-	0.375	0.500	0.625	0.750	-	-	-	-
Nominal screen tube diameter		-	in.	1/4	3/8	1/2	5/8	3/4	15/16	1/4	3/8	1/2	5/8
Carbide drill bit nominal size (ANSI)		d_{bit}	in.	3/8	1/2	5/8	3/4	7/8	1	1/2	9/16	3/4	7/8
Maximum torque, for threaded rods (only possible after full cure time of adhesive)		T_{max}	ft.-lb. (N-m)	4 (5)	6 (8)	10 (14)	10 (14)	10 (14)	-	4 (5)	6 (8)	10 (14)	10 (14)

For Unreinforced Masonry (URM Walls) see separate installation details and information in this section for 'Retrofit Bolt Anchors in URM Walls'.

Detail of Steel Hardware Elements used with Injection Adhesive System

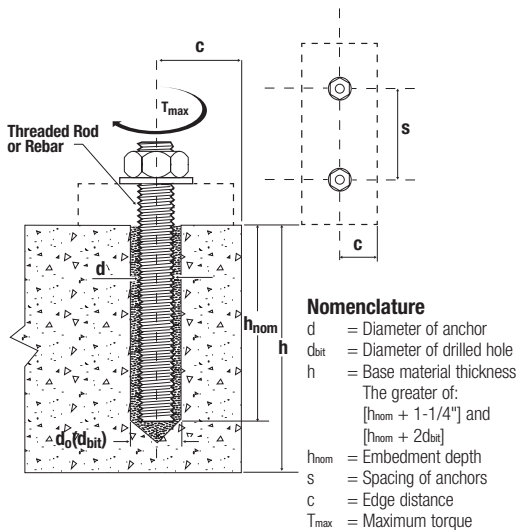

Threaded Rod and Deformed Reinforcing Bar Material Properties

Steel Description (General)	Steel Specification (ASTM)	Nominal Anchor Size (inch)	Minimum Yield Strength, f_y (ksi)	Minimum Ultimate Strength, f_u (ksi)
Carbon Rod	A36 or F1554 Grade 36	3/8 through 1-1/4	36.0	58.0
Stainless Rod (Alloy 304 / 316)	F593, Condition CW	3/8 through 5/8	65.0	100.0
		3/4 through 1-1/4	45.0	85.0
High Strength Carbon Rod	A193 Grade B7	3/8 through 1-1/4	105.0	125.0
Reinforcing Bar	A615, A767, Grade 75	3/8 through 1-1/4 (#3 through #10)	75.0	100.0
	A615, A767, Grade 60	3/8 through 1-1/4 (#3 through #10)	60.0	90.0
	A706, A767, Grade 60	3/8 through 1-1/4 (#3 through #10)	60.0	80.0
	A615, A767, Grade 40	3/8 through 1-1/4 (#3 through #10)	40.0	60.0



ADHESIVES

AC100+ GOLD®
Vinylester Injection Adhesive Anchoring System

TECHNICAL GUIDE -- ADHESIVES ©2020 DEWALT -- REV.F

Ultimate and Allowable Load Capacities for AC100+ Gold Installed into Normal Weight Concrete with Threaded Rod and Reinforcing Bar (based on bond strength/concrete capacity)^{1,2,3,4,5,6}

Nominal Rod Diameter or Rebar Size d in. or #	Minimum Embedment Depth h _{nom} in.	Minimum Concrete Compressive Strength							
		f'c = 3,000 psi		f'c = 4,000 psi		f'c = 5,000 psi		f'c = 6,000 psi	
		Ultimate Tension Load Capacity lbs (kN)	Allowable Tension Load Capacity lbs (kN)	Ultimate Tension Load Capacity lbs (kN)	Allowable Tension Load Capacity lbs (kN)	Ultimate Tension Load Capacity lbs (kN)	Allowable Tension Load Capacity lbs (kN)	Ultimate Tension Load Capacity lbs (kN)	Allowable Tension Load Capacity lbs (kN)
3/8 or #3	2-3/8	4,840 (21.5)	1,210 (5.4)	5,040 (22.4)	1,260 (5.6)	5,180 (23.0)	1,295 (5.8)	5,320 (23.7)	1,330 (5.9)
	3-1/2	7,140 (31.8)	1,785 (7.9)	7,420 (33.0)	1,855 (8.3)	7,640 (34.0)	1,910 (8.5)	7,820 (34.8)	1,955 (8.7)
	4-1/2	9,180 (40.8)	2,295 (10.2)	9,540 (42.4)	2,385 (10.6)	9,820 (43.7)	2,455 (10.9)	10,060 (44.7)	2,515 (11.2)
1/2 or #4	2-3/4	7,980 (35.5)	1,995 (8.9)	8,280 (36.8)	2,070 (9.2)	8,540 (38.0)	2,135 (9.5)	8,740 (38.9)	2,185 (9.7)
	4-3/8	12,720 (56.6)	3,180 (14.1)	13,200 (58.7)	3,300 (14.7)	13,580 (60.4)	3,395 (15.1)	13,900 (61.8)	3,475 (15.5)
	6	17,420 (77.5)	4,355 (19.4)	18,100 (80.5)	4,525 (20.1)	18,620 (82.8)	4,655 (20.7)	19,080 (84.9)	4,770 (21.2)
5/8 or #5	3-1/8	11,220 (49.9)	2,805 (12.5)	11,660 (51.9)	2,915 (13.0)	12,000 (53.4)	3,000 (13.3)	12,300 (54.7)	3,075 (13.7)
	5-1/4	19,200 (85.4)	4,800 (21.4)	19,960 (88.8)	4,990 (22.2)	20,540 (91.4)	5,135 (22.8)	21,020 (93.5)	5,255 (23.4)
	7-1/2	27,660 (123.0)	6,915 (30.8)	28,720 (127.8)	7,180 (31.9)	29,560 (131.5)	7,390 (32.9)	30,280 (134.7)	7,570 (33.7)
3/4 or #6	3-1/2	13,320 (59.3)	3,330 (14.8)	13,820 (61.5)	3,455 (15.4)	14,220 (63.3)	3,555 (15.8)	14,560 (64.8)	3,640 (16.2)
	6-1/4	26,880 (119.6)	6,720 (29.9)	27,900 (124.1)	6,975 (31.0)	28,720 (127.8)	7,180 (31.9)	29,420 (130.9)	7,355 (32.7)
	9	40,440 (179.9)	10,110 (45.0)	42,000 (186.8)	10,500 (46.7)	43,220 (192.3)	10,805 (48.1)	44,260 (196.9)	11,065 (49.2)
7/8 or #7	3-1/2	13,320 (59.3)	3,330 (14.8)	13,820 (61.5)	3,455 (15.4)	14,220 (63.3)	3,555 (15.8)	14,560 (64.8)	3,640 (16.2)
	7	36,680 (163.2)	9,170 (40.8)	38,080 (169.4)	9,520 (42.3)	39,200 (174.4)	9,800 (43.6)	40,140 (178.6)	10,035 (44.6)
	10-1/2	60,040 (267.1)	15,010 (66.8)	62,340 (277.3)	15,585 (69.3)	64,180 (285.5)	16,045 (71.4)	65,700 (292.2)	16,425 (73.1)
1 or #8	4	16,260 (72.3)	4,065 (18.1)	16,880 (75.1)	4,220 (18.8)	17,380 (77.3)	4,345 (19.3)	17,800 (79.2)	4,450 (19.8)
	8	46,540 (207.0)	11,635 (51.8)	48,300 (214.8)	12,075 (53.7)	49,740 (221.3)	12,435 (55.3)	50,920 (226.5)	12,730 (56.6)
	12	76,820 (341.7)	19,205 (85.4)	79,740 (354.7)	19,935 (88.7)	82,080 (365.1)	20,520 (91.3)	84,060 (373.9)	21,015 (93.5)
1-1/4 or #10	5	22,740 (101.2)	5,685 (25.3)	23,600 (105.0)	5,900 (26.2)	24,300 (108.1)	6,075 (27.0)	24,880 (110.7)	6,220 (27.7)
	10	65,880 (293.0)	16,470 (73.3)	68,400 (304.3)	17,100 (76.1)	70,420 (313.2)	17,605 (78.3)	72,100 (320.7)	18,025 (80.2)
	15	109,040 (485.0)	27,260 (121.3)	113,200 (503.5)	28,300 (125.9)	116,540 (518.4)	29,135 (129.6)	119,320 (530.8)	29,830 (132.7)

1. Allowable load capacities listed are calculated using an applied safety factor of 4.0 which includes an assessment of freezing/thawing conditions and sensitivity to sustained loads (i.e. creep resistance). Consideration of safety factors of 10 or higher may be necessary depending on the application, such as life safety or overhead.
2. Linear interpolation may be used to determine allowable loads for intermediate embedments and compressive strengths.
3. The tabulated load values are applicable to single anchors installed at critical edge and spacing distances and where the minimum member thickness is the greater of [h_{nom} + 1-1/4] and [h_{nom} + 2d_{ba}].
4. The tabulated load values are applicable for dry concrete. Holes must be drilled with a hammer drill and an ANSI carbide drill bit. Installations into saturated (wet) concrete and water-filled holes require a reduction in capacity for tabulated values of 15 percent and 50 percent, respectively. Contact DEWALT for more information concerning these installation conditions.
5. Adhesives experience reductions in capacity at elevated temperatures. See the In-Service Temperature chart for allowable loads capacity reduction factors.
6. Allowable bond strength/concrete capacity must be checked against allowable steel strength to determine the controlling allowable load. Allowable shear capacity is controlled by allowable steel strength for the given conditions.



Allowable Load Capacities for Threaded Rod and Reinforcing Bar (Based on Steel Strength)^{1,2,3,4,5}

Nominal Rod Diameter or Rebar Size (in. or #)	Steel Elements - Threaded Rod and Reinforcing Bar																	
	A36 or F1554, Grade 36		A36 or F1554, Grade 55		A 193, Grade B7 or F1554, Grade 105		F 593, CW (SS)		ASTM A615 Grade 40 Rebar		ASTM A615 Grade 60 Rebar		ASTM A706 Grade 60 Rebar		ASTM A615 Grade 75 Rebar		ASTM A706 Grade 80 Rebar	
	Tension lbs. (kN)	Shear lbs. (kN)	Tension lbs. (kN)	Shear lbs. (kN)	Tension lbs. (kN)	Shear lbs. (kN)	Tension lbs. (kN)	Shear lbs. (kN)	Tension lbs. (kN)	Shear lbs. (kN)	Tension lbs. (kN)	Shear lbs. (kN)	Tension lbs. (kN)	Shear lbs. (kN)	Tension lbs. (kN)	Shear lbs. (kN)	Tension lbs. (kN)	Shear lbs. (kN)
3/8 or #3	2,115 (9.4)	1,090 (4.8)	2,735 (12.2)	1,410 (6.3)	4,555 (20.3)	2,345 (10.4)	3,645 (16.2)	1,880 (8.4)	2,210 (9.8)	1,125 (5.0)	2,650 (11.8)	1,690 (7.5)	2,650 (11.8)	1,500 (6.7)	2,650 (11.8)	1,875 (8.3)	2,650 (11.8)	1,875 (8.3)
1/2 or #4	3,760 (16.7)	1,935 (8.6)	4,860 (21.6)	2,505 (11.1)	8,100 (36.0)	4,170 (18.5)	6,480 (28.8)	3,340 (14.9)	3,925 (17.5)	2,005 (8.9)	4,710 (21.0)	3,005 (13.4)	4,710 (21.0)	2,670 (11.9)	4,710 (21.0)	3,335 (14.8)	4,710 (21.0)	3,335 (14.8)
5/8 or #5	5,870 (26.1)	3,025 (13.5)	7,595 (33.8)	3,910 (17.4)	12,655 (56.3)	6,520 (29.0)	10,125 (45.0)	5,215 (23.2)	6,135 (27.3)	3,130 (13.9)	7,365 (32.8)	4,695 (20.9)	7,365 (32.8)	4,170 (18.5)	7,365 (32.8)	5,215 (23.2)	7,365 (32.8)	5,215 (23.2)
3/4 or #6	8,455 (37.6)	4,355 (19.4)	10,935 (48.6)	5,635 (25.1)	18,225 (81.1)	9,390 (41.8)	12,390 (55.1)	6,385 (28.4)	8,835 (39.3)	4,505 (20.0)	10,605 (47.2)	6,760 (30.1)	10,605 (47.2)	6,010 (26.7)	10,605 (47.2)	7,510 (33.4)	10,605 (47.2)	7,510 (33.4)
7/8 or #7	11,510 (51.2)	5,930 (26.4)	14,885 (66.2)	7,665 (34.1)	24,805 (110.3)	12,780 (56.8)	16,865 (75.0)	8,690 (38.7)	-	-	14,430 (64.2)	9,200 (40.9)	14,430 (64.2)	8,180 (36.4)	14,430 (64.2)	10,220 (45.5)	14,430 (64.2)	10,220 (45.5)
1 or #8	15,035 (66.9)	7,745 (34.5)	19,440 (86.5)	10,015 (44.5)	32,400 (144.1)	16,690 (74.2)	22,030 (98.0)	11,350 (50.5)	-	-	18,850 (83.8)	12,015 (53.4)	18,850 (83.8)	10,680 (47.5)	18,850 (83.8)	13,350 (59.4)	18,850 (83.8)	13,350 (59.4)
#9	-	-	-	-	-	-	-	-	-	-	23,985 (106.7)	15,290 (68.0)	23,985 (106.7)	13,590 (60.5)	23,985 (106.7)	16,990 (75.6)	23,985 (106.7)	16,990 (75.6)
1-1/4	23,490 (104.5)	12,100 (53.8)	30,375 (135.1)	15,645 (69.6)	50,620 (225.2)	26,080 (116.0)	34,425 (153.1)	17,735 (78.9)	-	-	-	-	-	-	-	-	-	-
#10	-	-	-	-	-	-	-	-	-	-	30,405 (135.2)	19,380 (86.2)	30,405 (135.2)	17,230 (76.6)	30,405 (135.2)	21,535 (95.8)	30,405 (135.2)	21,535 (95.8)

1. AISC defined steel strength (ASD) for threaded rod: Tensile = $0.33 \cdot F_u \cdot A_{nom}$, Shear = $0.17 \cdot F_u \cdot A_{nom}$
2. For reinforcing bars: The allowable steel tensile strength is based on 20 ksi for Grade 40 and 24 ksi for Grade 60 and higher, applied to the cross sectional area of the bar; allowable steel shear strength = $0.17 \cdot F_u \cdot A_{nom}$
3. Allowable load capacities are calculated for the steel element type. Consideration of applying additional safety factors may be necessary depending on the application, such as life safety or overhead.
4. Allowable steel strength in tension must be checked against allowable bond strength/concrete capacity in tension to determine the controlling allowable load.
5. The tabulated load values are applicable to single anchors installed at critical edge and spacing distances and where the minimum member thickness is the greater of $[t_{nom} + 1-1/4"]$ and $[t_{nom} + 2d_{bar}]$

In-Service Temperature Chart For Allowable Load Capacities

Concrete Base Materials

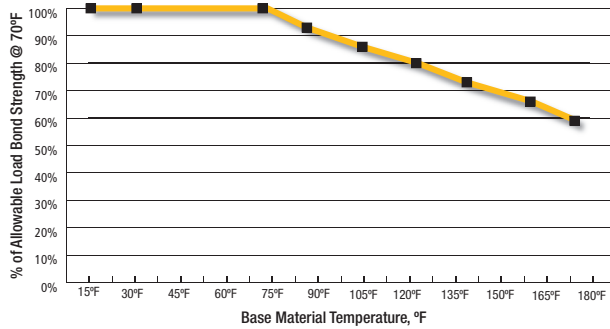

Masonry Units

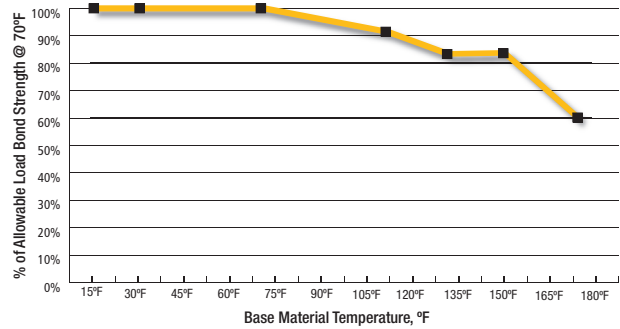

Allowable Load Capacities for Threaded Rod Installed with AC100+ Gold into Grout-Filled Concrete Masonry (Based on Bond Strength/Masonry Strength)^{1,2,3,7,9,12}



Anchor Diameter d inch	Minimum Embedment h _{nom} inch	Critical Spacing Distance S _{cr} inch	Minimum Edge Distance C _{min} inch	Minimum End Distance C _{min} inch	Tension Load lbs	Direction of Shear Loading	Shear Load lbs
Anchor Installed Into Grouted Masonry Wall Faces^{4,5,6,8,10,11,13}							
3/8	3	6	3	3	615	Towards Edge/End	275
			3	3	615	Away From Edge/End	340
			3	4	735	Any	490
			12	12	960	Any	855
1/2	4	8	3	3	720	Towards Edge/End	430
			3	3	720	Away From Edge/End	1320
			4	4	985	Any	655
			12	12	960	Towards Edge/End	1430
			12	12	960	Away From Edge/End	1760
			7-3/4 (Bed Joint)	3	935	Load To Edge	460
5/8	5	10	3	3	710	Towards Edge/End	460
			3	3	710	Away From Edge/End	1410
			12	12	1095	Towards Edge/End	1530
			12	12	1095	Away From Edge/End	1880
			7-3/4 (Bed Joint)	3	1030	Load To Edge	590
3/4	6	12	4	4	755	Towards Edge/End	630
			4	4	755	Away From Edge/End	1450
			12	12	1160	Towards Edge/End	1570
			12	12	1160	Away From Edge/End	1930
			7-3/4 (Bed Joint)	4	945	Load To Edge	565

Anchor Installed Into Tops of Grouted Masonry Walls^{14,15}

Anchor Diameter d inch	Minimum Embedment h _{nom} inch	Minimum Spacing Distance	Minimum Edge Distance C _{min} inch	Minimum End Distance C _{min} inch	Tension Load lbs	Direction of Shear Loading	Shear Load lbs
1/2	2-3/4	1 anchor per cell	1-3/4	4	595	Any	300
	4			3	520	Load To Edge	190
	4			3	520	Load To End	300
	10	1 anchor per block ¹⁶		10-1/2	1670	Load To Edge	190
	10			10-1/2	1670	Load To End	300
5/8	5	1 anchor per cell	1-3/4	3	745	Load To Edge	240
	5			3	745	Load To End	300
	12-1/2	1 anchor per block ¹⁶		10-1/2	2095	Load To Edge	240
	12-1/2			10-1/2	2095	Load To End	300
3/4	6	1 anchor per cell	1-3/4	4	1260	Load To Edge	410
	6			4	1260	Load To End	490

1. Tabulated load values are for anchors installed in nominal 8-inch wide (203 mm) Grade N, Type II, lightweight, medium-weight or normal-weight grout filled concrete masonry units with a minimum masonry strength, f'm, of 1,500 psi (10.3 MPa) conforming to ASTM C 90. If the specified compressive strength of the masonry, f'm, is 2,000 psi (13.8 MPa) minimum the tabulated values may be increased by 4 percent (multiplied by 1.04).
2. Allowable bond or masonry strengths in tension and shear are calculated using a safety factor of 5.0 and must be checked against the allowable tension and shear capacities for threaded rod based on steel strength to determine the controlling factor. See allowable load table based on steel strength.
3. Embedment is measured from the outside surface of the concrete masonry unit to the embedded end of the anchor.
4. Anchors may be installed in the grouted cells, cell webs and bed joints not closer than 1-1/2-inch from the vertical mortar joint (head joint) provided the minimum edge and end distances are maintained. Anchors may be placed in the head joint if the vertical joint is mortared full-depth.
5. A maximum of two anchors may be installed in a single masonry cell in accordance with the spacing and edge or end distance requirements.
6. The critical spacing, S_{cr}, for use with the anchor values shown in this table is 16 anchor diameters. The critical spacing, S_{cr}, distance is the distance where the full load values in the table may be used. The minimum spacing distance, S_{min}, is the minimum anchor spacing for which values are available and installation is permitted. For 3/8-inch diameter anchors, the spacing may be reduced to 8 anchor diameters when using a tension reduction factor of 0.70 and a shear reduction factor of 0.45. For 1/2 - and 5/8 - inch diameter anchors, the spacing may be reduced to 8 anchor diameters when using a tension reduction factor of 0.85 and a shear reduction factor of 0.45. For 3/4-inch diameter anchors, the spacing may be reduced to 8 anchor diameters when using a tension reduction factor of 1.00 and a shear reduction factor of 0.45.
7. Spacing distance is measured from the centerline to centerline between two anchors.
8. The critical edge or end distance, C_{cr}, is the distance where full load values in the table may be used. The minimum edge or end distance, C_{min}, is the minimum distance for which values are available and installation is permitted.
9. Edge or end distance is measured from anchor centerline to the closest unrestrained edge.
10. Linear interpolation of load values between the minimum spacing, S_{min}, and critical spacing, S_{cr}, distances and between minimum edge or end distance, C_{min}, and critical edge or end distance, C_{cr}, is permitted.
11. The tabulated values are applicable for anchors in the ends of grout-filled concrete masonry units where minimum edge and end distances are maintained.
12. The tabulated values must be adjusted for increased in-service base material temperatures in accordance with the In-Service Temperature chart, as applicable.
13. Concrete masonry width (wall thickness) must be equal to or greater than 1.5 times the anchor embedment depth (e.g. 3/8-inch and 1/2-inch diameter anchors are permitted in nominally 6-inch-thick concrete masonry). The 5/8-inch and 3/4-inch diameter anchors must be installed in minimum nominally 8-inch-thick concrete masonry.
14. Anchors must be installed into the grouted cell; anchors are not permitted to be installed in a head joint, flange or web of the concrete masonry unit.
15. Allowable shear loads parallel or perpendicular to the edge of a masonry wall may be applied in or out of plane.
16. Anchors with minimum spacing distance of one anchor per block may not be installed in adjacent cells (i.e. one cell must separate the anchor locations).

AC100+ Gold Adhesive Anchors Installed into Grouted Concrete Masonry Wall

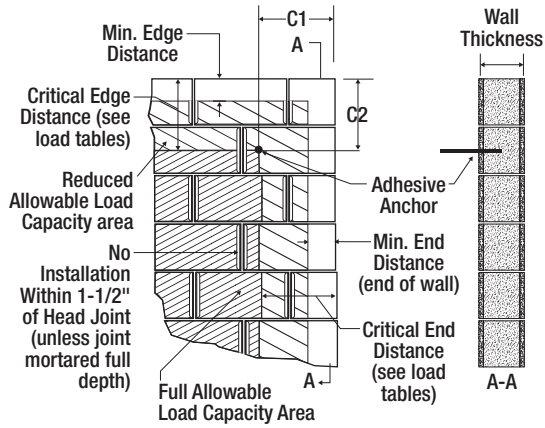

AC100+ Gold Adhesive Anchors Installed into Top of Grouted Concrete Masonry Wall

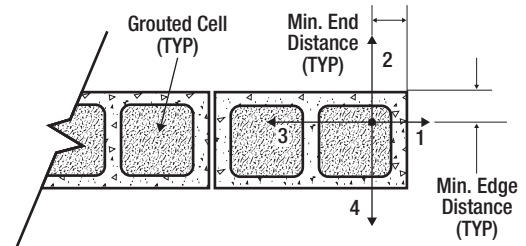

1. Shear load parallel to Edge and perpendicular to End
2. Shear load parallel to End and perpendicular to Edge
3. Shear load parallel to Edge and perpendicular away from End
4. Shear load parallel to End and perpendicular to opposite Edge

AC100+ Gold Adhesive Anchors Installed into Hollow Concrete Masonry Wall

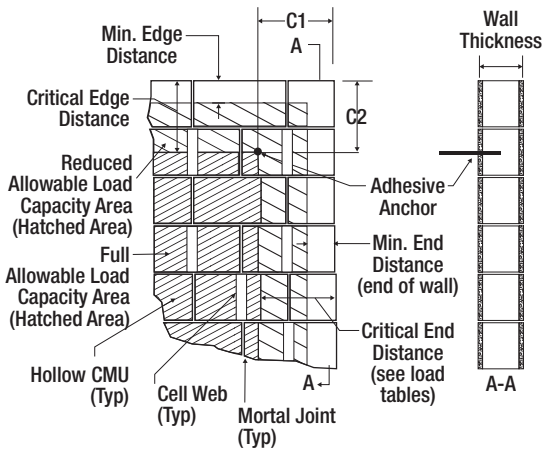

Direction of Shear Loading in Relation to Edge and End of Masonry Wall

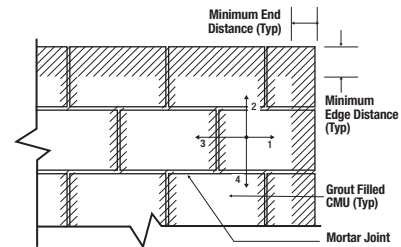

1. Shear load parallel to Edge and perpendicular to End
2. Shear load parallel to End and perpendicular to Edge
3. Shear load parallel to Edge and perpendicular away from End
4. Shear load parallel to End and perpendicular away from Edge

Allowable Load Capacities for Threaded Rod Installed with AC100+ Gold into Hollow Concrete Masonry Walls with Stainless Steel and Plastic Screen Tubes

1,2,3,4,5,6,7,8,9,10,11,12,13



Anchor Diameter d inch	Screen Tube type	Minimum Embedment h _{nom} inch (mm)	Critical Spacing Distance s _c inch (mm)	Minimum Edge Distance c _{min} inch (mm)	Minimum End Distance c _{min} inch (mm)	Allowable Load		
						Tension Load lbs (kN)	Direction of Shear Loading	Shear Load lbs (kN)
1/4	Stainless Steel	1-1/4 (32)	4 (102)	1-1/2 (38)	1-1/2 (38)	280 (1.2)	Towards Edge/End	140 (0.6)
		1-1/4 (32)	4 (102)	3 (76)	3 (76)	350 (1.6)	Towards Edge/End	275 (1.2)
		1-1/4 (32)	4 (102)	1-1/2 (38)	1-1/2 (38)	280 (1.2)	Away From Edge/End	235 (1.0)
		1-1/4 (32)	4 (102)	3 (76)	3 (76)	350 (1.6)	Away From Edge/End	465 (2.1)
	Plastic	1-1/4 (32)	1 anchor per cell	3 (76)	3 (76)	140 (0.6)	Towards Edge/End	235 (1.0)
		1-1/4 (32)	1 anchor per cell	3 (76)	3 (76)	140 (0.6)	Towards Edge/End	235 (1.0)
3/8	Stainless Steel	1-1/4 (32)	6 (152)	1-7/8 (48)	1-7/8 (48)	320 (1.4)	Towards Edge/End	145 (0.6)
		1-1/4 (32)	6 (152)	3-3/4 (95)	3-3/4 (95)	400 (1.8)	Towards Edge/End	290 (1.3)
		1-1/4 (32)	6 (152)	1-7/8 (48)	1-7/8 (48)	320 (1.4)	Away From Edge/End	245 (1.1)
		1-1/4 (32)	6 (152)	3-3/4 (95)	3-3/4 (95.3)	400 (1.8)	Away From Edge/End	490 (2.2)
	Plastic	1-1/4 (32)	1 anchor per cell	3 (76)	3 (76.2)	140 (0.6)	Towards Edge/End	235 (1.0)
		1-1/4 (32)	1 anchor per cell	3 (76)	3 (76.2)	140 (0.6)	Towards Edge/End	235 (1.0)
1/2	Stainless Steel	1-1/4 (32)	8 (203)	3-3/4 (95)	3-3/4 (95.3)	380 (1.7)	Towards Edge/End	215 (1.0)
		1-1/4 (32)	8 (203)	11-1/4 (286)	11-1/4 (286)	400 (1.8)	Towards Edge/End	430 (1.9)
		1-1/4 (32)	8 (203)	3-3/4 (95)	3-3/4 (95)	380 (1.7)	Away From Edge/End	365 (1.6)
		1-1/4 (32)	8 (203)	11-1/4 (285.8)	11-1/4 (286)	400 (1.8)	Away From Edge/End	730 (3.2)
	Plastic	1-1/4 (32)	1 anchor per cell	3 (76.2)	3 (76)	150 (0.7)	Towards Edge/End	215 (1.0)
		1-1/4 (32)	1 anchor per cell	3 (76.2)	3 (76)	150 (0.7)	Towards Edge/End	215 (1.0)
5/8	Stainless Steel	1-1/4 (32)	8 (203.2)	3-3/4 (95)	3-3/4 (95)	380 (1.7)	Towards Edge/End	215 (1.0)
		1-1/4 (31.8)	8 (203.2)	11-1/4 (286)	11-1/4 (286)	400 (1.8)	Towards Edge/End	430 (1.9)
		1-1/4 (31.8)	8 (203.2)	3-3/4 (95)	3-3/4 (95)	380 (1.7)	Away From Edge/End	365 (1.6)
		1-1/4 (31.8)	8 (203.2)	11-1/4 (286)	11-1/4 (286)	400 (1.8)	Away From Edge/End	730 (3.2)
	Plastic	1-1/4 (31.8)	1 anchor per cell	3 (76.2)	3 (76)	150 (0.7)	Towards Edge/End	215 (1.0)
		1-1/4 (31.8)	1 anchor per cell	3 (76.2)	3 (76)	150 (0.7)	Towards Edge/End	215 (1.0)
3/4	Stainless Steel	1-1/4 (32)	8 (203)	3-3/4 (95)	3-3/4 (95)	380 (1.7)	Towards Edge/End	215 (1.0)
		1-1/4 (32)	8 (203)	11-1/4 (286)	11-1/4 (286)	400 (1.8)	Towards Edge/End	430 (1.9)
		1-1/4 (32)	8 (203)	3-3/4 (95)	3-3/4 (95)	380 (1.7)	Away From Edge/End	365 (1.6)
		1-1/4 (32)	8 (203)	11-1/4 (286)	11-1/4 (286)	400 (1.8)	Away From Edge/End	730 (3.2)

1. Tabulated load values are for anchors installed in hollow concrete masonry with minimum masonry strength, f'm, of 1,500 psi (10.3 MPa). Concrete masonry units must be lightweight, medium-weight or normal-weight conforming to ASTM C 90. Allowable loads have been calculated using a safety factor of 5.0.
2. Anchors must be installed into the hollow cell; anchors are not permitted to be installed in a mortar joint, flange or web of the concrete masonry unit.
3. A maximum of two anchor may be installed in a single masonry cell in accordance with the spacing and edge distance requirements, except as noted in the table.
4. Embedment is measured from the outside surface of the concrete masonry unit to the embedded end of the anchor.
5. Edge or end distance is measured from anchor centerline to the closest unrestrained edge of the CMU block.
6. The critical spacing, s_c, for use with the anchor values shown in this table is 16 anchor diameters, except as noted in the table. The critical spacing, s_c, distance is the distance where the full load values in the table may be used. The minimum spacing distance, s_{min}, is the minimum anchor spacing for which values are available and installation is permitted. The spacing may be reduced to 8 anchor diameters by multiplying the tension load value by a reduction factor of 0.60 and multiplying the shear load value by a reduction factor of 0.45.
7. Spacing distance is measured from the centerline to centerline between two anchors.
8. Linear interpolation of load values between the minimum spacing, s_{min}, and critical spacing, s_c, distances and between minimum edge or end distance, c_{min}, and critical edge or end distance, c_c, is permitted if applicable.
9. Concrete masonry width (wall thickness) may be minimum nominal 6-inch-thick provided the minimum embedment (i.e. face shell thickness) is maintained.
10. The tabulated values are applicable for anchors in the ends of hollow concrete masonry units where minimum face shell thickness, minimum edge and end distances are maintained.
11. Anchors are recognized to resist dead, live and wind tension and shear load applications.
12. Allowable loads must be the lesser of the adjusted masonry or bond values tabulated above and the steel strength values.
13. The tabulated values must be adjusted for increased in-service base material temperatures in accordance with the In-Service Temperature chart, as applicable.

ADHESIVES

AC100+ GOLD®
Vinylester Injection Adhesive Anchoring System

TECHNICAL GUIDE – ADHESIVES ©2020 DEWALT – REV.F

Ultimate and Allowable Load Capacities for AC100+ Gold into Precast Hollow Core Concrete with Stainless Steel Screen Tubes^{1,2,3,4,5,6,7}

Anchor Diameter d in.	Drill Bit Diameter d _{bit} in.	Minimum Embedment h _{nom} in. (mm)	Minimum End Distance in. (mm)	Minimum Edge Distance in. (mm)	Ultimate Load		Allowable Load	
					Tension lbs. (kN)	Shear lbs. (kN)	Tension lbs. (kN)	Shear lbs. (kN)
1/4	3/8	1-1/2 (38)	4 (102)	4 (102)	900 (4.0)	1,550 (6.9)	180 (0.8)	310 (1.4)
3/8	1/2	1-1/2 (38)	6 (152)	6 (152)	1,975 (8.8)	3,650 (16.2)	395 (1.8)	730 (3.2)
1/2	5/8	1-1/2 (38)	8 (203)	8 (203)	4,400 (19.6)	5,875 (26.1)	880 (3.9)	1,175 (5.2)

1. Tabulated load values are for anchors installed in precast hollow core concrete with minimum strength, f'c, of 5,000 psi (34.5 MPa). Allowable loads have been calculated using a safety factor of 5.0.
2. Anchors must be installed into the hollow core; anchors are not permitted to be installed in a cell web of the hollow core concrete member.
3. Embedment is measured from the outside surface of the concrete to the embedded end of the anchor.
4. Edge or end distance is measured from anchor centerline to the closest unrestrained edge of the concrete member.
5. The tabulated values are for anchors installed at a minimum of 16 anchor diameters on center for 100 percent capacity. Spacing distance is measured from the centerline to centerline between two anchors.
6. Allowable loads must be the lesser of the adjusted concrete or bond values tabulated above and the steel strength values.
7. The tabulated values must be adjusted for increased in-service base material temperatures in accordance with the In-Service Temperature chart, as applicable.

Ultimate and Allowable Load Capacities for Knurled Dropins Installed with AC100+ Gold into Normal Weight Concrete^{1,2,3,4,5}

Anchor Diameter d in.	Knurled Dropin Anchor Cat. No.	Drill Bit Diameter in.	Minimum Embedment h _{nom} in. (mm)	Minimum Edge Distance in. (mm)	Ultimate Load		Allowable Load	
					Tension lbs. (kN)	Shear lbs. (kN)	Tension lbs. (kN)	Shear lbs. (kN)
1/4	6340	1/2	1 (25)	2 (51)	1,340 (6.0)	1,880 (8.4)	335 (1.5)	470 (2.1)
3/8	6342	5/8	1-9/16 (40)	3 (76)	2,740 (12.2)	3,800 (16.9)	685 (3.0)	950 (4.2)
1/2	6344	3/4	2 (51)	4 (102)	3,160 (14.1)	5,460 (24.3)	790 (3.5)	1,365 (6.1)

1. Allowable load capacities listed are calculated using an applied safety factor of 4.0. Consideration of safety factors of 10 or higher may be necessary depending on the application, such as life safety.
2. Knurled dropin anchors installed with AC100+ Gold adhesive are not recommended for overhead applications.
3. The tabulated values are for anchors installed at a minimum of 16 anchor diameters on center for 100 percent capacity. Spacing distance is measured from the centerline to centerline between two anchors.
4. The tabulated values must be adjusted for increased in-service base material temperatures in accordance with the In-Service Temperature chart, as applicable.
5. Tabulated allowable capacities must be checked against allowable steel strength of the threaded rod insert to determine the controlling allowable load.

Ultimate and Allowable Load Capacities for Threaded Rod Installed with AC100+ Gold into Brick Masonry Walls^{1,2,3,4}



Anchor Diameter d in.	Drill Diameter d _{bit} in.	Minimum Embedment h _{nom} in. (mm)	Minimum End Distance in. (mm)	Minimum Edge Distance in. (mm)	Ultimate Load		Allowable Load	
					Tension lbs. (kN)	Shear lbs. (kN)	Tension lbs. (kN)	Shear lbs. (kN)
Anchors Installed into the Face of Brick Masonry Walls								
3/8	1/2	3-1/2 (89)	2-1/2 (64)	2-1/2 (64)	3,600 (16.0)	4,505 (20.0)	720 (3.2)	900 (4.0)
		3-1/2 (89)	6 (152)	6 (152)	5,845 (26.0)	4,580 (20.4)	1,170 (5.2)	915 (4.1)
		6 (152)	6 (152)	6 (152)	10,420 (46.4)	4,580 (20.4)	2,085 (9.3)	915 (4.1)
1/2	5/8	6 (152)	8 (203)	8 (203)	11,500 (51.2)	9,300 (41.4)	2,300 (10.2)	1,860 (8.3)
5/8	3/4	3-1/8 (79)	9-1/2 (241)	9-1/2 (241)	4,715 (21.0)	7,700 (34.3)	945 (4.2)	1,540 (6.6)
		6 (152)	9-1/2 (241)	9-1/2 (241)	9,925 (44.2)	7,700 (34.3)	1,985 (8.8)	1,540 (6.6)
Anchors Installed into the Top of Brick Masonry Walls								
3/8	1/2	3-1/2 (89)	2-1/2 (64)	2-1/2 (64)	3,665 (16.3)	2,435 (10.8)	735 (3.3)	485 (2.2)

1. Tabulated load values are for anchors installed in minimum 2 wythe, Grade SW, solid clay brick masonry conforming to ASTM C 62. Mortar must be N, S or M.
2. Allowable loads are calculated using an applied safety factor of 5.0. Consideration of safety factors of 10 or higher may be necessary depending on the application, such as life safety.
3. Allowable loads apply to installations in the face of brick or mortar joint. The tabulated values are for anchors installed at a minimum of 16 anchor diameters on center for 100 percent capacity.
4. The tabulated values must be adjusted for increased in-service base material temperatures in accordance with the In-Service Temperature chart, as applicable.

Allowable Load Capacities for Threaded Rods and Reinforcing Bars or Rebar Dowel with AC100+ Gold Installed in Unreinforced Masonry Walls with Stainless Steel Screen Tubes (Retrofit Bolt Anchors in URM Walls)^{1,2}

Shear Anchor – Configuration A (See Figure 1)

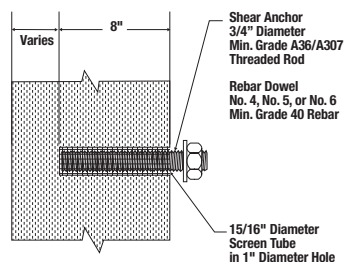

Figure 1

Rod Dia. or Rebar Size d in.	Minimum Embed. h _{nom} in. (mm)	Minimum Wall Thickness in. (mm)	Allowable Tension lbs. (kN)	Allowable Shear lbs. (kN)
3/4	8 (203)	13 (330)	-	1,000 (4.5)
No. 4	8 (203)	13 (330)	-	500 (2.3)
No. 5	8 (203)	13 (330)	-	750 (3.4)
No. 6	8 (203)	13 (330)	-	1,000 (4.5)

1. Allowable load values are applicable only where in-place shear tests indicate minimum mortar strength of 35 psi net.
2. The anchors installed in unreinforced brick walls are limited to resisting seismic or wind loads only.

22-1/2° Combination Anchor – Configuration B (See Figure 2)

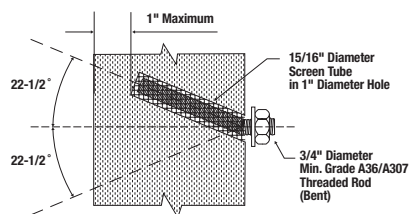

Figure 2

Rod Dia. or Rebar Size d in.	Minimum Embed. h _{nom} in. (mm)	Minimum Wall Thickness in. (mm)	Allowable Tension lbs. (kN)	Allowable Shear lbs. (kN)
3/4	Within 1 inch (25mm) of opposite wall surface	13 (330)	1,200 (5.4)	1,000 (4.5)

1. Allowable load values are applicable only where in-place shear tests indicate minimum mortar strength of 35 psi net.
2. The anchors installed in unreinforced brick walls are limited to resisting seismic or wind loads only.

Anchor Description	Minimum Vertical Spacing in.	Minimum Horizontal Spacing in.	Minimum Edge Distance in.
Shear Anchor - Configuration A (See Figure 1)	16	16	16
22-1/2° Combination Anchor - Configuration B (See Figure 2)	16	16	16

STRENGTH DESIGN (SD)

CODE LISTED
ICC-ES ESR-2582



Strength Design Installation Table for AC100+ Gold¹

Parameter	Symbol	Units	Fractional Nominal Rod Diameter (Inch) / Reinforcing Bar Size									
			3/8 or #3	1/2	#4	5/8 or #5	3/4 or #6	7/8 or #7	1 or #8	#9	1-1/4	#10
Threaded rod outside diameter	d _a	inch (mm)	0.375 (9.5)	0.500 (12.7)	0.625 (15.9)	0.750 (19.1)	0.875 (22.2)	1.000 (25.4)	-	1.250 (31.8)	-	
Rebar nominal outside diameter	d _a	inch (mm)	0.375 (9.5)	0.500 (12.7)	0.625 (15.9)	0.750 (19.1)	0.875 (22.2)	1.000 (25.4)	1.125 (28.7)	-	1.250 (31.8)	
Carbide drill bit nominal size	d _o (d _{bit})	inch	7/16	9/16	5/8	11/16 or 3/4	7/8	1	1-1/8	1-3/8	1-3/8	1-1/2
Minimum embedment	h _{ef,min}	inch (mm)	2-3/8 (60)	2-3/4 (70)	3-1/8 (79)	3-1/2 (89)	3-1/2 (89)	4 (102)	4-1/2 (114)	5 (127)	5 (127)	
Maximum embedment	h _{ef,max}	inch (mm)	4-1/2 (114)	6 (152)	7-1/2 (191)	9 (229)	10-1/2 (267)	12 (305)	13-1/2 (343)	15 (381)	15 (381)	
Minimum member thickness	h _{min}	inch (mm)	h _{ef} + 1-1/4 (h _{ef} + 30)				h _{ef} + 2d _o					
Minimum anchor spacing	s _{min}	inch (mm)	1-7/8 (48)	2-1/2 (64)	3-1/8 (79)	3-3/4 (95)	4-3/8 (111)	5 (127)	5-5/8 (143)	6-1/4 (159)	6-1/4 (159)	
Minimum edge distance, reduced ⁵	c _{min,red}	inch (mm)	1-3/4 (45)	1-3/4 (45)	1-3/4 (45)	1-3/4 (45)	1-3/4 (45)	1-3/4 (45)	2-3/4 (70)	2-3/4 (70)	2-3/4 (70)	
Minimum edge distance	c _{min}	inch (mm)	1-7/8 (48)	2-1/2 (64)	3-1/8 (79)	3-3/4 (95)	4-3/8 (111)	5 (127)	5-5/8 (143)	6-1/4 (159)	6-1/4 (159)	
Max. rod torque ²	T _{max}	ft-lbs	15	33	60	105	125	165	-	280	-	
Max. torque ^{2,3} (A36/Grade 36 rod)	T _{max}	ft-lbs	10	25	50	90	125	165	-	280	-	
Max. torque ^{2,4} (Class 1 SS rod)	T _{max}	ft-lbs	5	20	40	60	100	165	-	280	-	

For pound-inch units: 1 mm = 0.03937 inch, 1 N-m = 0.7375 ft-lbf. For SI: 1 inch = 25.4 mm, 1 ft-lbf = 1.356 N-m.

- For use with the design provisions of ACI 318-14 Ch. 17 or ACI 318-11 Appendix D as applicable and ICC-ES AC308, Section 4.2 and ESR-2582.
- Torque may not be applied to the anchors until the full cure time of the adhesive has been achieved.
- These torque values apply to ASTM A 36 / F 1554 Grade 36 carbon steel threaded rods.
- These torque values apply to ASTM A 193 Grade B8/B8M (Class 1) stainless steel threaded rods.
- For installation between the minimum edge distance, c_{min}, and the reduced minimum edge distance, c_{min,red}, the maximum torque must be reduced (multiplied) by a factor of 0.45.

Detail of Steel Hardware Elements used with Injection Adhesive System

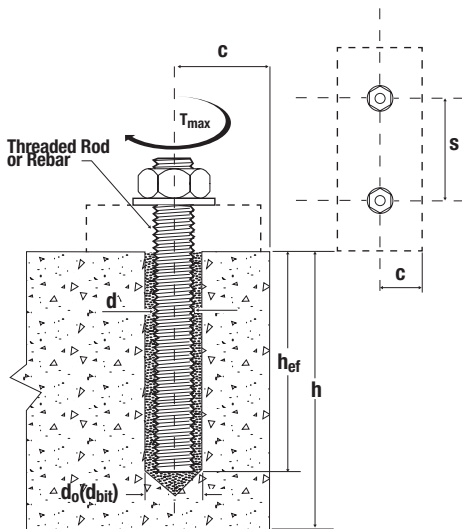

Threaded Rod and Deformed Reinforcing Bar Material Properties

Steel Description (General)	Steel Specification (ASTM)	Nominal Anchor Size (inch)	Minimum Yield Strength, f _y (ksi)	Minimum Ultimate Strength, f _u (ksi)
Carbon rod	ASTM A 36 and F 1554 Grade 36	3/8 through 1-1/4	36.0	58.0
	ASTM F 1554 Grade 55	3/8 through 1-1/4	55.0	75.0
	ASTM A 449	3/8 through 1 1-1/4	92.0 81.0	120.0 105.0
High Strength Carbon rod	ASTM A 193 Grade B7 and F 1554 Grade 105	3/8 through 1-1/4	105.0	125.0
Stainless rod (Alloy 304/316)	ASTM F 593 Condition CW	3/8 through 5/8 3/4 through 1-1/4	65.0 45.0	100.0 85.0
	ASTM A 193 Grade B8/B8M, Class 1	3/8 through 1-1/4	30.0	75.0
	ASTM A 193 Grade B8/B8M2, Class 2B	3/8 through 1-1/4	75.0	95.0
Reinforcing Bar	ASTM A 615, A 767, Grade 75	3/8 through 1-1/4 (#3 through #10)	75.0	100.0
	ASTM A 615, A 767, Grade 60	3/8 through 1-1/4 (#3 through #10)	60.0	90.0
	ASTM A 706, A 767, Grade 60	3/8 through 1-1/4 (#3 through #10)	60.0	80.0
	ASTM A 615, A 767, Grade 40	3/8 through 1-1/4 (#3 through #10)	40.0	60.0

**Steel Tension and Shear Design for Threaded Rod in Normal Weight Concrete
(For use with load combinations taken from ACI 318-14 Section 5.3)**

CODE LISTED
ICC-ES ESR-2582



Design Information		Symbol	Units	Nominal Rod Diameter* (inch)						
				3/8	1/2	5/8	3/4	7/8	1	1-1/4
Threaded rod nominal outside diameter		d_a	inch (mm)	0.375 (9.5)	0.500 (12.7)	0.625 (15.9)	0.750 (19.1)	0.875 (22.2)	1.000 (25.4)	1.250 (31.8)
Threaded rod effective cross-sectional area		A_{se}	inch ² (mm ²)	0.0775 (50)	0.1419 (92)	0.2260 (146)	0.3345 (216)	0.4617 (298)	0.6057 (391)	0.9691 (625)
ASTM A 36 and ASTM F 1554 Grade 36	Nominal strength as governed by steel strength (for a single anchor)	N_{sa}	lbf (kN)	4,495 (20.0)	8,230 (36.6)	13,110 (58.3)	19,400 (86.3)	26,780 (119.1)	35,130 (156.3)	56,210 (250.0)
		V_{sa}	lbf (kN)	2,695 (12.0)	4,940 (22.0)	7,860 (35.0)	11,640 (51.8)	16,070 (71.4)	21,080 (93.8)	33,725 (150.0)
	Reduction factor for seismic shear	αV_{seis}	-	0.80	0.80	0.80	0.80	0.80	0.80	0.80
	Strength reduction factor for tension ²	ϕ	-	0.75						
	Strength reduction factor for shear ²	ϕ	-	0.65						
ASTM F 1554 Grade 55	Nominal strength as governed by steel strength (for a single anchor)	N_{sa}	lbf (kN)	5,810 (25.9)	10,640 (47.3)	16,950 (75.4)	25,085 (111.6)	34,625 (154.0)	45,425 (202.0)	72,680 (323.3)
		V_{sa}	lbf (kN)	3,485 (15.5)	6,385 (28.4)	10,170 (45.2)	15,050 (67.0)	20,775 (92.4)	27,255 (121.2)	43,610 (194.0)
	Reduction factor for seismic shear	αV_{seis}	-	0.80	0.80	0.80	0.80	0.80	0.80	0.80
	Strength reduction factor for tension ²	ϕ	-	0.75						
	Strength reduction factor for shear ²	ϕ	-	0.65						
ASTM A 193 Grade B7 and ASTM F 1554 Grade 105	Nominal strength as governed by steel strength (for a single anchor)	N_{sa}	lbf (kN)	9,685 (43.1)	17,735 (78.9)	28,250 (125.7)	41,810 (186.0)	57,710 (256.7)	75,710 (336.8)	121,135 (538.8)
		V_{sa}	lbf (kN)	5,815 (25.9)	10,640 (7.3)	16,950 (75.4)	25,085 (111.6)	34,625 (154.0)	45,425 (202.1)	72,680 (323.3)
	Reduction factor for seismic shear	αV_{seis}	-	0.80	0.80	0.80	0.80	0.80	0.80	0.80
	Strength reduction factor for tension ²	ϕ	-	0.75						
	Strength reduction factor for shear ²	ϕ	-	0.65						
ASTM A 449	Nominal strength as governed by steel strength (for a single anchor)	N_{sa}	lbf (kN)	9,300 (41.4)	17,025 (75.7)	27,120 (120.6)	40,140 (178.5)	55,905 (248.7)	72,685 (323.3)	101,755 (452.6)
		V_{sa}	lbf (kN)	5,580 (24.8)	10,215 (45.4)	16,270 (72.4)	24,085 (107.1)	33,540 (149.2)	43,610 (194.0)	61,050 (271.6)
	Reduction factor for seismic shear	αV_{seis}	-	0.80	0.80	0.80	0.80	0.80	0.80	0.80
	Strength reduction factor for tension ²	ϕ	-	0.75						
	Strength reduction factor for shear ²	ϕ	-	0.65						
ASTM F 593 CW Stainless (Types 304 and 316)	Nominal strength as governed by steel strength (for a single anchor)	N_{sa}	lbf (kN)	7,750 (34.5)	14,190 (63.1)	22,600 (100.5)	28,430 (126.5)	39,245 (174.6)	51,485 (229.0)	82,370 (366.4)
		V_{sa}	lbf (kN)	4,650 (20.7)	8,515 (37.9)	13,560 (60.3)	17,060 (75.9)	23,545 (104.7)	30,890 (137.4)	49,425 (219.8)
	Reduction factor for seismic shear	αV_{seis}	-	0.70	0.70	0.80	0.80	0.80	0.80	0.80
	Strength reduction factor for tension ³	ϕ	-	0.65						
	Strength reduction factor for shear ³	ϕ	-	0.60						
ASTM A 193 Grade B8/B8M, Class 1 Stainless (Types 304 and 316)	Nominal strength as governed by steel strength (for a single anchor) ⁴	N_{sa}	lbf (kN)	4,420 (19.7)	8,090 (36.0)	12,880 (57.3)	19,065 (84.8)	26,315 (117.1)	34,525 (153.6)	55,240 (245.7)
		V_{sa}	lbf (kN)	2,650 (11.8)	4,855 (21.6)	7,730 (34.4)	11,440 (50.9)	15,790 (70.2)	20,715 (92.1)	33,145 (147.4)
	Reduction factor for seismic shear	αV_{seis}	-	0.70	0.70	0.80	0.80	0.80	0.80	0.80
	Strength reduction factor for tension ²	ϕ	-	0.75						
	Strength reduction factor for shear ²	ϕ	-	0.65						
ASTM A 193 Grade B8/ B8M2, Class 2B Stainless (Types 304 and 316)	Nominal strength as governed by steel strength (for a single anchor)	N_{sa}	lbf (kN)	7,365 (32.8)	13,480 (60.0)	21,470 (95.5)	31,775 (141.3)	43,860 (195.1)	57,545 (256.0)	92,065 (409.5)
		V_{sa}	lbf (kN)	4,420 (19.7)	8,085 (36.0)	12,880 (57.3)	19,065 (84.8)	26,315 (117.1)	34,525 (153.6)	55,240 (245.7)
	Reduction factor for seismic shear	αV_{seis}	-	0.70	0.70	0.80	0.80	0.80	0.80	0.80
	Strength reduction factor for tension ²	ϕ	-	0.75						
	Strength reduction factor for shear ²	ϕ	-	0.65						

For SI: 1 inch = 25.4 mm, 1 lbf = 4.448 N. For pound-inch units: 1 mm = 0.03937 inches, 1 N = 0.2248 lbf.

- Values provided for steel element material types are based on minimum specified strengths and calculated in accordance with ACI 318-14 Eq. 17.4.1.2 and Eq. 17.5.1.2b or ACI 318-11 Eq. (D-2) and Eq. (D-29), as applicable, except where noted. Nuts and washers must be appropriate for the rod. Nuts must have specified proof load stresses equal to or greater than the minimum tensile strength of the specified threaded rod.
- The tabulated value of ϕ applies when the load combinations of Section 1605.2 of the IBC, ACI 318-14 5.3 or ACI 318-11 9.2, as applicable, are used in accordance with ACI 318-14 17.3.3 or ACI 318-11 D.4.3, as applicable. If the load combinations of ACI 318-11 Appendix C are used, the appropriate value of ϕ must be determined in accordance with ACI 318 D.4.4. Values correspond to ductile steel elements.
- The tabulated value of ϕ applies when the load combinations of Section 1605.2 of the IBC, ACI 318-14 5.3 or ACI 318-11 9.2, as applicable, are used in accordance with ACI 318-14 17.3.3 or ACI 318-11 D.4.3, as applicable. If the load combinations of ACI 318-11 Appendix C are used, the appropriate value of ϕ must be determined in accordance with ACI 318 D.4.4. Values correspond to brittle steel elements.
- In accordance with ACI 318-14 17.4.1.2 and 17.5.1.2 or ACI 318-11 D.5.1.2 and D.6.1.2, as applicable, the calculated values for nominal tension and shear strength for ASTM A193 Grade B8/B8M Class 1 stainless steel threaded rods are based on limiting the specified tensile strength of the anchor steel to 1.9f_y or 57,000 psi (393 MPa).

ADHESIVES

AC100+ GOLD®
Vinylester Injection Adhesive Anchoring System

TECHNICAL GUIDE – ADHESIVES ©2020 DEWALT – REV.F

Steel Tension and Shear Design for Reinforcing Bars in Normal Weight Concrete
(For use with load combinations taken from ACI 318-14 Section 5.3)

CODE LISTED
 ICC-ES ESR-2582



Design Information		Symbol	Units	Nominal Reinforcing Bar Size (Rebar)							
				No. 3	No. 4	No. 5	No. 6	No. 7	No. 8	No. 9	No. 10
Rebar nominal outside diameter		d_a	inch (mm)	0.375 (9.5)	0.500 (12.7)	0.625 (15.9)	0.750 (19.1)	0.875 (22.2)	1.000 (25.4)	1.125 (28.7)	1.250 (32.3)
Rebar effective cross-sectional area		A_{se}	inch ² (mm ²)	0.110 (71.0)	0.200 (129.0)	0.310 (200.0)	0.440 (283.9)	0.600 (387.1)	0.790 (509.7)	1.000 (645.2)	1.270 (819.4)
ASTM A 615 Grade 75	Nominal strength as governed by steel strength (for a single anchor)	N_{sa}	lbf (kN)	11,000 (48.9)	20,000 (89.0)	31,000 (137.9)	44,000 (195.7)	60,000 (266.9)	79,000 (351.4)	100,000 (444.8)	127,000 (564.9)
		V_{sa}	lbf (kN)	6,600 (29.4)	12,000 (53.4)	18,600 (82.7)	26,400 (117.4)	36,000 (160.1)	47,400 (210.8)	60,000 (266.9)	76,200 (338.9)
	Reduction factor for seismic shear	αV_{seis}	-	0.70	0.70	0.80	0.80	0.80	0.80	0.80	0.80
	Strength reduction factor for tension ¹	ϕ	-	0.65							
	Strength reduction factor for shear ¹	ϕ	-	0.60							
ASTM A 615 Grade 60	Nominal strength as governed by steel strength (for a single anchor)	N_{sa}	lbf (kN)	9,900 (44.0)	18,000 (80.1)	27,900 (124.1)	39,600 (176.1)	54,000 (240.2)	71,100 (316.3)	90,000 (400.3)	114,300 (508.4)
		V_{sa}	lbf (kN)	5,940 (26.4)	10,800 (48.0)	16,740 (74.5)	23,760 (105.7)	32,400 (144.1)	42,660 (189.8)	54,000 (240.2)	68,580 (305.0)
	Reduction factor for seismic shear	αV_{seis}	-	0.70	0.70	0.80	0.80	0.80	0.80	0.80	0.80
	Strength reduction factor for tension ²	ϕ	-	0.75							
	Strength reduction factor for shear ²	ϕ	-	0.65							
ASTM A 706 Grade 60	Nominal strength as governed by steel strength (for a single anchor)	N_{sa}	lbf (kN)	8,800 (39.1)	16,000 (71.2)	24,800 (110.3)	35,200 (156.6)	48,000 (213.5)	63,200 (281.1)	80,000 (355.9)	101,600 (452.0)
		V_{sa}	lbf (kN)	5,280 (23.5)	9,600 (42.7)	14,880 (66.2)	21,120 (94.0)	28,800 (128.1)	37,920 (168.7)	48,000 (213.5)	60,960 (271.2)
	Reduction factor for seismic shear	αV_{seis}	-	0.70	0.70	0.80	0.80	0.80	0.80	0.80	0.80
	Strength reduction factor for tension ²	ϕ	-	0.75							
	Strength reduction factor for shear ²	ϕ	-	0.65							
ASTM A 615 Grade 40	Nominal strength as governed by steel strength (for a single anchor)	N_{sa}	lbf (kN)	6,600 (29.4)	12,000 (53.4)	18,600 (82.7)	26,400 (117.4)	In accordance with ASTM A 615, Grade 40 bars are furnished only in sizes No. 3 through No. 6			
		V_{sa}	lbf (kN)	3,960 (17.6)	7,200 (32.0)	11,160 (49.6)	15,840 (70.5)				
	Reduction factor for seismic shear	αV_{seis}	-	0.70	0.70	0.80	0.80				
	Strength reduction factor for tension ²	ϕ	-	0.75							
	Strength reduction factor for shear ²	ϕ	-	0.65							

1. Values provided for reinforcing bar material types based on minimum specified strengths and calculated in accordance with ACI 318-14 Eq. 17.4.1.2 and Eq. 17.5.1.2b or ACI 318-11 Eq. (D-2) and Eq. (D-29), as applicable.
2. The tabulated value of ϕ applies when the load combinations of Section 1605.2 of the IBC, ACI 318-14 5.3 or ACI 318-11 9.2, as applicable, are used in accordance with ACI 318-14 17.3.3 or ACI 318-11 D.4.3, as applicable. If the load combinations of ACI 318-11 Appendix C are used, the appropriate value of ϕ must be determined in accordance with ACI 318 D.4.4. Values correspond to ductile steel elements. In accordance with ACI 318-14 17.2.3.4.3(a)(vi) or ACI 318-11 D.3.3.4.3(a)6, as applicable, deformed reinforcing bars meeting this specification used as ductile steel elements to resist earthquake effects shall be limited to reinforcing bars satisfying the requirements of ACI 318-14 20.2.2.4 and 20.2.2.5 or ACI 318-11 21.1.5.2 (a) and (b), as applicable.
3. The tabulated value of ϕ applies when the load combinations of Section 1605.2 of the IBC, ACI 318-14 5.3 or ACI 318-11 9.2, as applicable, are used in accordance with ACI 318-14 17.3.3 or ACI 318-11 D.4.3, as applicable. If the load combinations of ACI 318-11 Appendix C are used, the appropriate value of ϕ must be determined in accordance with ACI 318 D.4.4. Values correspond to brittle steel elements.

Concrete Breakout Design Information for Threaded Rod and Reinforcing Bars
(For use with loads combinations taken from ACI 318-14 Section 5.3)¹

CODE LISTED
ICC-ES ESR-2582



Design Information	Symbol	Units	Nominal Rod Diameter (inch) / Reinforcing Bar Size							
			3/8 or #3	1/2 or #4	5/8 or #5	3/4 or #6	7/8 or #7	1 or #8	#9	1-1/4 or #10
Effectiveness factor for cracked concrete	$k_{c,cr}$	- (SI)	Not Applicable		17 (7.1)					
Effectiveness factor for uncracked concrete	$k_{c,uncr}$	- (SI)	24 (10.0)							
Minimum embedment	$h_{ef,min}$	inch (mm)	2-3/8 (60)	2-3/4 (70)	3-1/8 (79)	3-1/2 (89)	3-1/2 (89)	4 (102)	4-1/2 (114)	5 (127)
Maximum embedment	$h_{ef,max}$	inch (mm)	4-1/2 (114)	6 (152)	7-1/2 (191)	9 (229)	10-1/2 (267)	12 (305)	13-1/2 (343)	15 (381)
Minimum anchor spacing	s_{min}	inch (mm)	1-7/8 (48)	2-1/2 (64)	3-1/8 (79)	3-3/4 (95)	4-3/8 (111)	5 (127)	5-5/8 (143)	6-1/4 (159)
Minimum edge distance ²	c_{min}	inch (mm)	5d where d is nominal outside diameter of the anchor							
Minimum edge distance, reduced ²	$c_{min,red}$	inch (mm)	1-3/4 (45)	1-3/4 (45)	1-3/4 (45)	1-3/4 (45)	1-3/4 (45)	1-3/4 (45)	2-3/4 (70)	2-3/4 (70)
Minimum member thickness	h_{min}	inch (mm)	$h_{ef} + 1-1/4 (h_{ef} + 30)$		$h_{ef} + 2d_o$ where d_o is hole diameter;					
Critical edge distance—splitting (for uncracked concrete only) ³	c_{ac}	inch	$c_{ac} = h_{ef} \cdot \left(\frac{\tau_{k,uncr}}{1160} \right)^{0.4} \cdot [3.1 - 0.7 \frac{h}{h_{ef}}]$							
		(mm)	$c_{ac} = h_{ef} \cdot \left(\frac{\tau_{k,uncr}}{8} \right)^{0.4} \cdot [3.1 - 0.7 \frac{h}{h_{ef}}]$							
Strength reduction factor for tension, concrete failure modes, Condition B ⁴	ϕ	-	0.65							
Strength reduction factor for shear, concrete failure modes, Condition B ⁴	ϕ	-	0.70							

For SI: 1 inch = 25.4 mm, 1 lbf = 4.448 N. For pound-inch units: 1 mm = 0.03937 inch, 1 N = 0.2248 lbf.

- Additional setting information is described in the installation instructions.
- For installation between the minimum edge distance, c_{min} , and the reduced minimum edge distance, $c_{min,red}$, the maximum torque applied must be reduced (multiplied) by a factor of 0.45.
- $\tau_{k,uncr}$ need not be taken as greater than: $\tau_{k,uncr} = k_{uncr} \cdot \sqrt{h_{ef} \cdot f'_c}$ and h_{ef} need not be taken as larger than 2.4.
- Condition A requires supplemental reinforcement, while Condition B applies where supplemental reinforcement is not provided or where pryout governs, as set forth in ACI 318-14 17.3.3 or ACI 318-11 D.4.3, as applicable. The tabulated value of ϕ applies when the load combinations of Section 1605.2 of the IBC, ACI 318-14 5.3 or ACI 318-11 9.2, as applicable, are used in accordance with ACI 318-14 17.3.3 or ACI 318-11 D.4.3, as applicable. If the load combinations of ACI 318-11 Appendix C are used, the appropriate value of ϕ must be determined in accordance with ACI 318 D.4.4.

FLOWCHART FOR THE ESTABLISHMENT OF DESIGN BOND STRENGTH

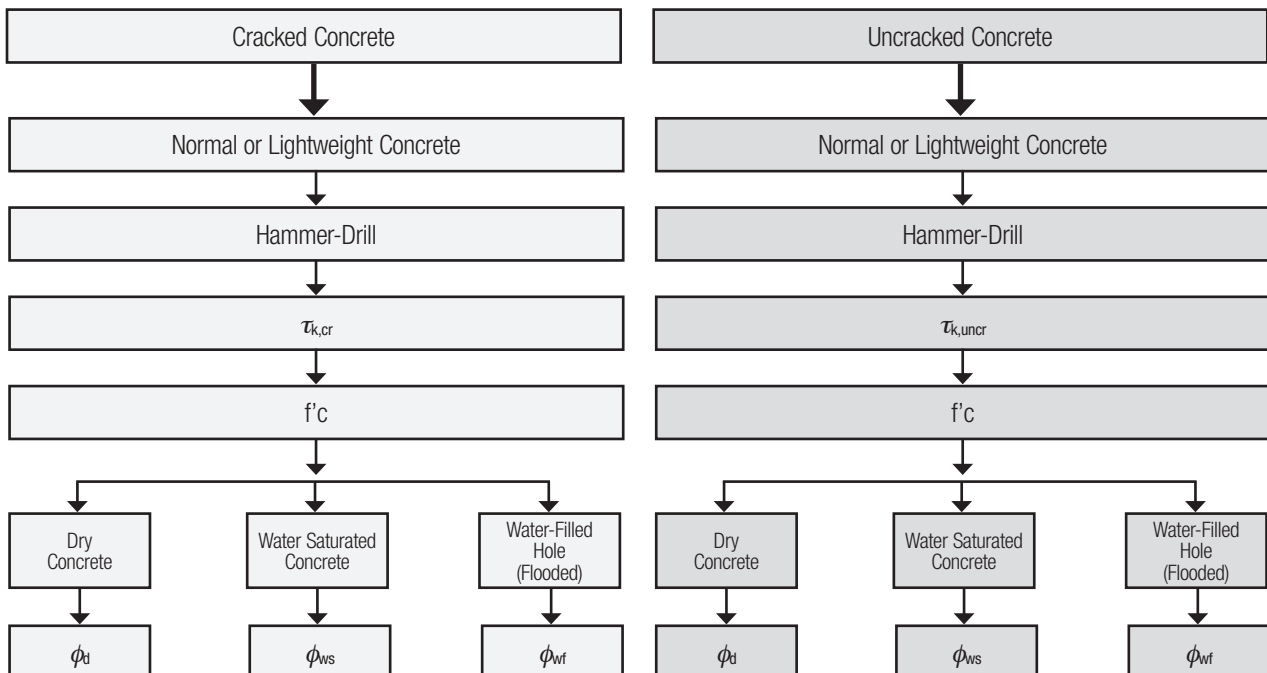

Bond Strength Design Information for Threaded Rods
(For use with load combinations taken from ACI 318-14 Section 5.3)^{1,2}



Design Information	Symbol	Units	Nominal Rod Diameter (Inch) / Reinforcing Bar Size							
			3/8	1/2	5/8	3/4	7/8	1	1-1/4	
Minimum embedment	$h_{ef,min}$	inch (mm)	2-3/8 (60)	2-3/4 (70)	3-1/8 (79)	3-1/2 (89)	3-1/2 (89)	4 (102)	5 (127)	
Maximum embedment	$h_{ef,max}$	inch (mm)	4-1/2 (114)	6 (152)	7-1/2 (191)	9 (229)	10-1/2 (267)	12 (305)	15 (381)	
122°F (50°C) Maximum Long-Term Service Temperature; 176°F (80°C) Maximum Short-Term Service Temperature ^{3,4}	Characteristic bond strength in cracked concrete ^{4,7}	$\tau_{k,cr}$	psi (N/mm ²)	Not Applicable	498 (3.4)	519 (3.6)	519 (3.6)	519 (3.6)	519 (3.6)	525 (3.6)
	Characteristic bond strength in uncracked concrete ^{4,8}	$\tau_{k,uncr}$	psi (N/mm ²)	823 (5.7)	823 (5.7)	823 (5.7)	823 (5.7)	823 (5.7)	743 (5.1)	588 (4.1)
									Not applicable in water-filled hole installation condition	
162°F (72°C) Maximum Long-Term Service Temperature; 248°F (120°C) Maximum Short-Term Service Temperature ^{3,4}	Characteristic bond strength in cracked concrete ^{4,7}	$\tau_{k,cr}$	psi (N/mm ²)	Not Applicable	245 (1.7)	255 (1.8)	255 (1.8)	255 (1.8)	255 (1.8)	255 (1.8)
	Characteristic bond strength in uncracked concrete ^{4,8}	$\tau_{k,uncr}$	psi (N/mm ²)	405 (2.8)	405 (2.8)	405 (2.8)	405 (2.8)	405 (2.8)	366 (2.5)	Not Applicable
									Not applicable in water-filled hole installation condition	
Permissible installation conditions ⁶	Dry concrete	ϕ_d	-	0.65			0.65	0.65	0.65	
	Water-saturated concrete	ϕ_{ws}	-	0.55			0.55	0.55	0.55	
	Water-filled hole (flooded)	ϕ_{wf}	-	0.45			0.45	0.45	0.45	
		κ_{wf}	-	0.78			0.70	0.69	0.67	
Reduction factor for seismic tension		$\alpha_{N,seis}$	-	0.95						

For SI: 1 inch = 25.4 mm, 1 psi = 0.006894 MPa. For pound-inch units: 1 mm = 0.03937 inch, 1 MPa = 145.0 psi.

- Bond strength values correspond to a normal-weight concrete compressive strength $f'_c = 2,500$ psi (17.2 MPa). For concrete compressive strength, f'_c between 2,500 psi and 8,000 psi (17.2 MPa and 55.2 MPa), the tabulated characteristic bond strength may be increased by a factor of $(f'_c / 2,500)^{0.13}$ [For SI: $(f'_c / 17.2)^{0.13}$].
- The modification factor for bond strength of adhesive anchors in lightweight concrete shall be taken as given in ACI 318-14 17.2.6 where applicable.
- Long-term and short-term temperatures meet the requirements of Section 8.5 of ACI 355.4 and Table 9.1, Temperature Category A.
- Short-term base material service temperatures are those that occur over brief intervals, e.g. as a result of diurnal cycling. Long-term base material service temperatures are roughly constant over significant periods of time.
- Characteristic bond strengths are for sustained loads including dead and live loads.
- Permissible installation conditions include dry concrete, water-saturated concrete and water-filled holes. Water-filled holes include applications in dry or water-saturated concrete where the drilled holes contain standing water at the time of anchor installation.
- For structures assigned to Seismic Design Categories C, D, E or F, the tabulated bond strength values for cracked concrete must be adjusted by an additional reduction factor, $\alpha_{N,seis}$, as given in this table.
- Bond strength values for uncracked concrete are applicable for structures assigned to Seismic Design Categories A and B only.



ADHESIVES

AC100+ GOLD®
Vinylester Injection Adhesive Anchoring System

Bond Strength Design Information for Reinforcing Bar
(For use with load combinations taken from ACI 318-14 Section 5.3)^{1,2}

Design Information	Symbol	Units	Nominal Rod Diameter (Inch) / Reinforcing Bar Size								
			#3	#4	#5	#6	#7	#8	#9	#10	
Minimum embedment	$h_{ef,min}$	inch (mm)	2-3/8 (60)	2-3/4 (70)	3-1/8 (79)	3-1/2 (89)	3-1/2 (89)	4 (102)	4-1/2 (114)	5 (127)	
Maximum embedment	$h_{ef,max}$	inch (mm)	4-1/2 (114)	6 (152)	7-1/2 (191)	9 (229)	10-1/2 (267)	12 (305)	13-1/2 (343)	15 (381)	
122°F (50°C) Maximum Long-Term Service Temperature; 176°F (80°C) Maximum Short-Term Service Temperature ^{3,4}	Characteristic bond strength in cracked concrete ^{4,7}	$\tau_{k,cr}$	psi (N/mm ²)	Not Applicable	331 (2.3)	345 (2.4)	345 (2.4)	345 (2.4)	345 (2.4)	349 (2.4)	349 (2.4)
	Characteristic bond strength in uncracked concrete ^{4,8}	$\tau_{k,uncr}$	psi (N/mm ²)	823 (5.7)	823 (5.7)	823 (5.7)	823 (5.7)	823 (5.7)	743 (5.1)	655 (4.5)	588 (4.1)
162°F (72°C) Maximum Long-Term Service Temperature; 248°F (120°C) Maximum Short-Term Service Temperature ^{3,4}	Characteristic bond strength in cracked concrete ^{4,7}	$\tau_{k,cr}$	psi (N/mm ²)	Not Applicable	163 (1.1)	170 (1.2)	170 (1.2)	170 (1.2)	170 (1.2)	170 (1.2)	170 (1.2)
	Characteristic bond strength in uncracked concrete ^{4,8}	$\tau_{k,uncr}$	psi (N/mm ²)	405 (2.8)	405 (2.8)	405 (2.8)	405 (2.8)	405 (2.8)	366 (2.5)	329 (2.3)	Not Applicable
Permissible installation conditions ⁵	Dry concrete	ϕ_d	-	0.65				0.65	0.65	0.65	0.65
	Water-saturated concrete	ϕ_{ws}	-	0.55				0.55	0.55	0.55	0.55
	Water-filled hole (flooded)	ϕ_{wf}	-	0.45				0.45	0.45	0.45	0.45
		K_{wf}	-	0.78				0.70	0.69	0.68	0.67
Reduction factor for seismic tension	$\alpha_{N,seis}$	-	0.95								

For Sl: 1 inch = 25.4 mm, 1 psi = 0.006894 MPa. For pound-inch units: 1 mm = 0.03937 inch, 1 MPa = 145.0 psi.

- Bond strength values correspond to a normal-weight concrete compressive strength $f'_c = 2,500$ psi (17.2 MPa). For concrete compressive strength, f'_c between 2,500 psi and 8,000 psi (17.2 MPa and 55.2 MPa), the tabulated characteristic bond strength may be increased by a factor of $(f'_c / 2,500)^{0.13}$ [For Sl: $(f'_c / 17.2)^{0.13}$].
- The modification factor for bond strength of adhesive anchors in lightweight concrete shall be taken as given in ACI 318-14 17.2.6 where applicable.
- Long-term and short-term temperatures meet the requirements of Section 8.5 of ACI 355.4 and Table 9.1, Temperature Category A.
- Short-term base material service temperatures are those that occur over brief intervals, e.g. as a result of diurnal cycling. Long-term base material service temperatures are roughly constant over significant periods of time.
- Characteristic bond strengths are for sustained loads including dead and live loads.
- Permissible installation conditions include dry concrete, water-saturated concrete and water-filled holes. Water-filled holes include applications in dry or water-saturated concrete where the drilled holes contain standing water at the time of anchor installation.
- For structures assigned to Seismic Design Categories C, D, E or F, the tabulated bond strength values for cracked concrete must be adjusted by an additional reduction factor, $\alpha_{N,seis}$, as given in this table.
- Bond strength values for uncracked concrete are applicable for structures assigned to Seismic Design Categories A and B only.



Tension and Shear Design Strength for Threaded Rod and Reinforcing Bar Installed in Uncracked Concrete (Bond or Concrete Strength)

Drilled with a Hammer-Drill and Carbide Bit in a Dry Hole Condition

122°F (50°C) Maximum Long-Term Service Temperature;

176°F (80°C) Maximum Short-Term Service Temperature^{1,2,3,4,5,6,7,8,9}

Nominal Rod/Rebar Size (in. or #)	Embed. Depth h_{ef} (in.)	Minimum Concrete Compressive Strength									
		$f'_c = 2,500$ (psi)		$f'_c = 3,000$ (psi)		$f'_c = 4,000$ (psi)		$f'_c = 6,000$ (psi)		$f'_c = 8,000$ (psi)	
		ϕN_{cb} or ϕN_a Tension (lbs.)	ϕN_{cb} or ϕN_{cp} Shear (lbs.)	ϕN_{cb} or ϕN_a Tension (lbs.)	ϕN_{cb} or ϕN_{cp} Shear (lbs.)	ϕN_{cb} or ϕN_a Tension (lbs.)	ϕN_{cb} or ϕN_{cp} Shear (lbs.)	ϕN_{cb} or ϕN_a Tension (lbs.)	ϕN_{cb} or ϕN_{cp} Shear (lbs.)	ϕN_{cb} or ϕN_a Tension (lbs.)	ϕN_{cb} or ϕN_{cp} Shear (lbs.)
3/8 or #3	2-3/8	1,495	1,610	1,535	1,650	1,590	1,715	1,675	1,805	1,740	1,875
	3	1,890	2,955	1,935	3,270	2,010	3,830	2,120	4,565	2,200	4,735
	4-1/2	2,835	5,395	2,905	5,965	3,015	6,495	3,180	6,845	3,300	7,105
1/2 or #4	2-3/4	2,310	2,780	2,365	3,075	2,455	3,605	2,590	4,505	2,690	5,280
	4	3,360	5,230	3,440	5,785	3,575	6,780	3,765	8,110	3,910	8,420
	6	5,040	9,530	5,165	10,540	5,360	11,545	5,650	12,170	5,865	12,630
5/8 or #5	3-1/8	3,280	3,695	3,360	4,085	3,490	4,785	3,680	5,990	3,820	7,020
	5	5,250	8,155	5,380	9,015	5,585	10,565	5,885	12,675	6,110	13,160
	7-1/2	7,880	14,850	8,065	16,420	8,375	18,035	8,825	19,015	9,165	19,735
3/4 or #6	3-1/2	4,285	4,730	4,380	5,230	4,535	6,130	4,760	7,670	4,925	8,990
	6	7,565	11,515	7,745	12,730	8,040	14,925	8,475	18,250	8,795	18,950
	9	11,345	20,970	11,615	23,190	12,060	25,975	12,710	27,380	13,195	28,420
7/8 or #7	3-1/2	4,370	4,930	4,475	5,470	4,635	6,410	4,865	8,020	5,040	9,400
	7	10,295	14,500	10,540	16,035	10,940	18,795	11,535	23,510	11,975	25,790
	10-1/2	15,440	26,410	15,810	29,210	16,415	34,235	17,300	37,265	17,960	38,685
1 or #8	4	5,210	6,045	5,325	6,685	5,515	7,835	5,795	9,800	6,000	11,490
	8	12,140	17,000	12,430	18,800	12,905	22,040	13,600	27,565	14,120	30,410
	12	18,205	30,965	18,645	34,245	19,355	40,140	20,400	43,940	21,180	45,615
#9	5	5,795	6,845	5,925	7,570	6,135	8,875	6,445	11,100	6,670	13,010
	10	13,545	19,320	13,865	21,365	14,395	25,045	15,175	31,325	15,755	33,930
	15	20,315	35,195	20,800	38,920	21,595	45,620	22,760	49,025	23,630	50,895
1-1/4	5	6,575	7,695	6,720	8,510	6,955	9,975	7,305	12,480	7,565	14,625
	10	15,010	21,630	15,370	23,920	15,955	28,035	16,820	35,065	17,460	37,605
	15	22,515	39,390	23,055	43,560	23,930	51,060	25,225	54,335	26,190	56,405
#10	5	6,490	7,685	6,635	8,495	6,870	9,960	7,215	12,455	7,470	14,600
	10	15,010	21,665	15,370	23,960	15,955	28,085	16,820	35,130	17,460	37,605
	15	22,515	39,465	23,055	43,640	23,930	51,155	25,225	54,335	26,190	56,405

■ - Concrete Breakout Strength □ - Bond Strength/Pryout Strength

- Tabular values are provided for illustration and are applicable for single anchors installed in uncracked normal-weight concrete with minimum slab thickness, $h_{ef} = h_{min}$, and with the following conditions:
 - c_{a1} is greater than or equal to the critical edge distance, c_{ac}
 - c_{a2} is greater than or equal to 1.5 times c_{a1} .
- Calculations were performed according to ACI 318-14, Ch.17 and ICC-ES AC308. The load level corresponding to the failure mode listed [Concrete breakout strength, bond strength/pryout strength] must be checked against the tabulated steel strength of the corresponding threaded rod or rebar size and type, the lowest load level controls.
- Strength reduction factors (ϕ) for concrete breakout strength are based on ACI 318-14 Section 5.3 for load combinations. Condition B was assumed.
- Strength reduction factors (ϕ) for bond strength are determined from reliability testing and qualification in accordance with ICC-ES AC308 and are tabulated in this product information and in ESR-2582.
- Tabular values are permitted for static loads only, seismic loading is not considered with these tables. Periodic special inspection must be performed where required by code, see ESR-2582 for applicable information.
- For anchors subjected to tension resulting from sustained loading a supplemental check must be performed according to ACI 318-14 17.3.1.2.
- For designs that include combined tension and shear, the interaction of tension and shear loads must be calculated in accordance with ACI 318-14, Ch.17.
- Interpolation is not permitted to be used with the tabular values. For intermediate base material compressive strengths, please see ACI 318-14, Ch.17, ICC-ES AC308 and information included in this product supplement. For other design conditions including seismic considerations please see ACI 318-14, Ch.17 and ICC-ES AC308 and ESR-2582.
- Long term concrete temperatures are roughly constant over significant periods of time. Short-term elevated temperatures are those that occur over brief intervals, e.g. as a result of diurnal cycling.



Tension and Shear Design Strength for Threaded Rod Installed in Cracked Concrete (Bond or Concrete Strength) Drilled with a Hammer-Drill and Carbide Bit in a Dry Hole Condition
122°F (50°C) Maximum Long-Term Service Temperature;
176°F (80°C) Maximum Short-Term Service Temperature^{1,2,3,4,5,6,7,8,9}

Nominal Rod/Rebar Size (in.)	Embed. Depth h_{ef} (in.)	Minimum Concrete Compressive Strength									
		$f'_c = 2,500$ (psi)		$f'_c = 3,000$ (psi)		$f'_c = 4,000$ (psi)		$f'_c = 6,000$ (psi)		$f'_c = 8,000$ (psi)	
		ϕN_{cb} or ϕN_a Tension (lbs.)	ϕV_{cb} or ϕV_{cp} Shear (lbs.)	ϕN_{cb} or ϕN_a Tension (lbs.)	ϕV_{cb} or ϕV_{cp} Shear (lbs.)	ϕN_{cb} or ϕN_a Tension (lbs.)	ϕV_{cb} or ϕV_{cp} Shear (lbs.)	ϕN_{cb} or ϕN_a Tension (lbs.)	ϕV_{cb} or ϕV_{cp} Shear (lbs.)	ϕN_{cb} or ϕN_a Tension (lbs.)	ϕV_{cb} or ϕV_{cp} Shear (lbs.)
1/2	2-3/4	1,400	1,985	1,430	2,195	1,485	2,575	1,565	3,220	1,625	3,505
	4	2,035	3,735	2,085	4,130	2,160	4,655	2,280	4,910	2,365	5,095
	6	3,050	6,570	3,125	6,730	3,245	6,985	3,420	7,365	3,550	7,645
5/8	3-1/8	2,070	2,640	2,120	2,915	2,200	3,420	2,320	4,275	2,410	5,015
	5	3,310	5,825	3,390	6,440	3,520	7,550	3,710	7,995	3,855	8,300
	7-1/2	4,970	10,605	5,085	10,955	5,280	11,375	5,565	11,990	5,780	12,445
3/4	3-1/2	2,705	3,380	2,760	3,735	2,860	4,380	3,000	5,480	3,105	6,420
	6	4,770	8,225	4,885	9,095	5,070	10,660	5,345	11,510	5,550	11,950
	9	7,155	14,980	7,325	15,780	7,605	16,380	8,015	17,265	8,320	17,925
7/8	3-1/2	2,755	3,525	2,820	3,910	2,920	4,580	3,070	5,730	3,180	6,715
	7	6,490	10,360	6,645	11,455	6,900	13,425	7,275	15,665	7,550	16,265
	10-1/2	9,735	18,865	9,970	20,865	10,350	22,295	10,910	23,500	11,325	24,395
1	4	3,640	4,320	3,720	4,775	3,855	5,595	4,045	7,000	4,190	8,205
	8	8,480	12,145	8,680	13,430	9,015	15,740	9,500	19,690	9,865	21,240
	12	12,720	22,120	13,025	24,460	13,520	28,670	14,250	30,695	14,795	31,865
1-1/4	5	5,870	5,495	6,000	6,080	6,210	7,125	6,525	8,915	6,755	10,445
	10	13,400	15,450	13,720	17,085	14,245	20,025	15,015	25,050	15,590	29,360
	15	20,100	28,135	20,585	31,115	21,370	36,470	22,525	45,620	23,385	50,365

■ - Concrete Breakout Strength ■ - Bond Strength/Pryout Strength

- Tabular values are provided for illustration and are applicable for single anchors installed in cracked normal-weight concrete with minimum slab thickness, $h_a = h_{min}$, and with the following conditions:
 - C_{a1} is greater than or equal to the critical edge distance, C_{ac}
 - C_{a2} is greater than or equal to 1.5 times C_{a1} .
- Calculations were performed according to ACI 318-14 Ch.17 and ICC-ES AC308. The load level corresponding to the failure mode listed [Concrete breakout strength, bond strength/pryout strength] must be checked against the tabulated steel strength of the corresponding threaded rod or rebar size and type, the lowest load level controls.
- Strength reduction factors (ϕ) for concrete breakout strength are based on ACI 318-14 Section 5.3 for load combinations. Condition B was assumed.
- Strength reduction factors (ϕ) for bond strength are determined from reliability testing and qualification in accordance with ICC-ES AC308 and are tabulated in this product information and in ESR-2582.
- Tabular values are permitted for static loads only, seismic loading is not considered with these tables. Periodic special inspection must be performed where required by code, see ESR-2582 for applicable information.
- For anchors subjected to tension resulting from sustained loading a supplemental check must be performed according to ACI 318-14 17.3.1.2.
- For designs that include combined tension and shear, the interaction of tension and shear loads must be calculated in accordance with ACI 318-14 Ch.17.
- Interpolation is not permitted to be used with the tabular values. For intermediate base material compressive strengths, please see ACI 318-14 Ch.17, ICC-ES AC308 and information included in this product supplement. For other design conditions including seismic considerations please see ACI 318-14 Ch.17 and ICC-ES AC308 and ESR-2582.
- Long term concrete temperatures are roughly constant over significant periods of time. Short-term elevated temperatures are those that occur over brief intervals, e.g. as a result of diurnal cycling.

ADHESIVES

AC100+ GOLD®
Vinylester Injection Adhesive Anchoring System

**Tension and Shear Design Strength for Reinforcing Bar Installed in Cracked Concrete (Bond or Concrete Strength)
 Drilled with a Hammer-Drill and Carbide Bit in a Dry Hole Condition
 122°F (50°C) Maximum Long-Term Service Temperature;
 176°F (80°C) Maximum Short-Term Service Temperature^{1,2,3,4,5,6,7,8,9}**



Nominal Rod/Rebar Size (#)	Embed. Depth h_{ef} (in.)	Minimum Concrete Compressive Strength									
		$f'_c = 2,500$ (psi)		$f'_c = 3,000$ (psi)		$f'_c = 4,000$ (psi)		$f'_c = 6,000$ (psi)		$f'_c = 8,000$ (psi)	
		ϕN_{cb} or ϕN_{cs} Tension (lbs.)	ϕV_{cb} or ϕV_{cs} Shear (lbs.)	ϕN_{cb} or ϕN_{cs} Tension (lbs.)	ϕV_{cb} or ϕV_{cs} Shear (lbs.)	ϕN_{cb} or ϕN_{cs} Tension (lbs.)	ϕV_{cb} or ϕV_{cs} Shear (lbs.)	ϕN_{cb} or ϕN_{cs} Tension (lbs.)	ϕV_{cb} or ϕV_{cs} Shear (lbs.)	ϕN_{cb} or ϕN_{cs} Tension (lbs.)	ϕV_{cb} or ϕV_{cs} Shear (lbs.)
#4	2-3/4	930	1,985	950	2,050	990	2,130	1,040	2,245	1,080	2,330
	4	1,350	2,910	1,385	2,980	1,435	3,095	1,515	3,265	1,575	3,385
	6	2,030	4,365	2,075	4,470	2,155	4,645	2,270	4,895	2,360	5,080
#5	3-1/8	1,375	2,640	1,410	2,915	1,465	3,150	1,540	3,320	1,600	3,445
	5	2,200	4,740	2,255	4,855	2,340	5,040	2,465	5,315	2,560	5,515
	7-1/2	3,300	7,115	3,380	7,285	3,510	7,560	3,700	7,970	3,840	8,275
#6	3-1/2	1,795	3,380	1,835	3,735	1,900	4,095	1,995	4,300	2,065	4,450
	6	3,170	6,830	3,245	6,990	3,370	7,260	3,550	7,650	3,690	7,945
	9	4,755	10,240	4,870	10,490	5,055	10,890	5,330	11,475	5,530	11,915
#7	3-1/2	1,830	3,525	1,875	3,910	1,945	4,185	2,040	4,395	2,110	4,550
	7	4,315	9,295	4,420	9,515	4,585	9,880	4,835	10,415	5,020	10,810
	10-1/2	6,475	13,940	6,630	14,275	6,880	14,820	7,255	15,620	7,530	16,215
#8	4	2,420	4,320	2,475	4,775	2,560	5,515	2,690	5,795	2,785	6,000
	8	5,635	12,140	5,770	12,430	5,990	12,905	6,315	13,600	6,555	14,120
	12	8,455	18,210	8,655	18,645	8,985	19,355	9,475	20,405	9,835	21,180
#9	5	3,090	4,890	3,155	5,410	3,270	6,340	3,435	7,395	3,555	7,655
	10	7,215	13,800	7,390	15,260	7,670	16,520	8,085	17,415	8,395	18,080
	15	10,825	23,315	11,085	23,870	11,505	24,780	12,130	26,125	12,590	27,120
#10	5	3,855	5,490	3,940	6,070	4,080	7,115	4,280	8,900	4,435	9,550
	10	8,910	15,475	9,120	17,115	9,470	20,060	9,980	21,500	10,365	22,320
	15	13,365	28,190	13,685	29,470	14,205	30,595	14,975	32,250	15,545	33,480

■ - Concrete Breakout Strength ■ - Bond Strength/Pryout Strength

- Tabular values are provided for illustration and are applicable for single anchors installed in cracked normal-weight concrete with minimum slab thickness, $h_{sa} = h_{min}$, and with the following conditions:
 - c_{a1} is greater than or equal to the critical edge distance, c_{ac}
 - c_{a2} is greater than or equal to 1.5 times c_{a1} .
- Calculations were performed according to ACI 318-14 Ch.17 and ICC-ES AC308. The load level corresponding to the failure mode listed [Concrete breakout strength, bond strength/pryout strength] must be checked against the tabulated steel strength of the corresponding threaded rod or rebar size and type, the lowest load level controls.
- Strength reduction factors (ϕ) for concrete breakout strength are based on ACI 318-14 Section 5.3 for load combinations. Condition B was assumed.
- Strength reduction factors (ϕ) for bond strength are determined from reliability testing and qualification in accordance with ICC-ES AC308 and are tabulated in this product information and in ESR-2582.
- Tabular values are permitted for static loads only, seismic loading is not considered with these tables. Periodic special inspection must be performed where required by code, see ESR-2582 for applicable information.
- For anchors subjected to tension resulting from sustained loading a supplemental check must be performed according to ACI 318-14 17.3.1.2.
- For designs that include combined tension and shear, the interaction of tension and shear loads must be calculated in accordance with ACI 318-14 Ch.17.
- Interpolation is not permitted to be used with the tabular values. For intermediate base material compressive strengths, please see ACI 318-14 Ch.17, ICC-ES AC308 and information included in this product supplement. For other design conditions including seismic considerations please see ACI 318-14 Ch.17 and ICC-ES AC308 and ESR-2582.
- Long term concrete temperatures are roughly constant over significant periods of time. Short-term elevated temperatures are those that occur over brief intervals, e.g. as a result of diurnal cycling.



ADHESIVES

AC100+ GOLD®
Vinylester Injection Adhesive Anchoring System

Tension Design of Steel Elements (Steel Strength)^{1,2}

Steel Elements - Threaded Rod and Reinforcing Bar										
Nominal Rod/Rebar Size (in. or No.)	ASTM A36 and ASTM F1554 Grade 36	ASTM F1554 Grade 55	ASTM A193 Grade B7 and ASTM F1554 Grade 105	ASTM F593 CW Stainless (Types 304 and 316)	ASTM A193 Grade B8/ B8M, Class 1 Stainless (Types 304 and 316)	ASTM A193 Grade B8/ B8M2, Class 2B Stainless (Types 304 and 316)	ASTM A615 Grade 75 Rebar	ASTM A615 Grade 60 Rebar	ASTM A706 Grade 60 Rebar	ASTM A615 Grade 40 Rebar
	ϕN_{sa} Tension (lbs.)	ϕN_{sa} Tension (lbs.)	ϕN_{sa} Tension (lbs.)	ϕN_{sa} Tension (lbs.)	ϕN_{sa} Tension (lbs.)	ϕN_{sa} Tension (lbs.)	ϕN_{sa} Tension (lbs.)	ϕN_{sa} Tension (lbs.)	ϕN_{sa} Tension (lbs.)	ϕN_{sa} Tension (lbs.)
3/8 or #3	3,370	4,360	7,265	5,040	3,315	5,525	7,150	7,425	6,600	4,950
1/2 or #4	6,175	7,980	13,300	9,225	6,070	10,110	13,000	13,500	12,000	9,000
5/8 or #5	9,835	12,715	21,190	14,690	9,660	16,105	20,150	20,925	18,600	13,950
3/4 or #6	14,550	18,815	31,360	18,480	14,300	23,830	28,600	29,700	26,400	19,800
7/8 or #7	20,085	25,970	43,285	25,510	19,735	32,895	39,000	40,500	36,000	-
1 or #8	26,350	34,070	56,785	33,465	25,895	43,160	51,350	53,325	47,400	-
#9	-	-	-	-	-	-	65,000	67,500	60,000	-
1-1/4 or #10	42,160	54,510	90,850	53,540	41,430	69,050	82,550	85,725	76,200	-

■ - Steel Strength

1. Steel tensile design strength according to ACI 318-14 Ch.17 Appendix D, $\phi N_{sa} = \phi \cdot A_{se,N} \cdot f_{uta}$
2. The tabulated steel design strength in tension must be checked against the bond strength/concrete capacity design strength to determine the controlling failure mode, the lowest load level controls.

Shear Design of Steel Elements (Steel Strength)^{1,2}

Steel Elements - Threaded Rod and Reinforcing Bar										
Nominal Rod/Rebar Size (in. or No.)	ASTM A36 and ASTM F1554 Grade 36	ASTM F1554 Grade 55	ASTM A193 Grade B7 and ASTM F1554 Grade 105	ASTM F593 CW Stainless (Types 304 and 316)	ASTM A193 Grade B8/ B8M, Class 1 Stainless (Types 304 and 316)	ASTM A193 Grade B8/ B8M2, Class 2B Stainless (Types 304 and 316)	ASTM A615 Grade 75 Rebar	ASTM A615 Grade 60 Rebar	ASTM A706 Grade 60 Rebar	ASTM A615 Grade 40 Rebar
	ϕN_{sa} Tension (lbs.)	ϕN_{sa} Tension (lbs.)	ϕN_{sa} Tension (lbs.)	ϕN_{sa} Tension (lbs.)	ϕN_{sa} Tension (lbs.)	ϕN_{sa} Tension (lbs.)	ϕN_{sa} Tension (lbs.)	ϕN_{sa} Tension (lbs.)	ϕN_{sa} Tension (lbs.)	ϕN_{sa} Tension (lbs.)
3/8 or #3	1,755	2,265	3,775	2,790	1,725	2,870	3,960	3,860	3,430	2,575
1/2 or #4	3,210	4,150	6,915	5,110	3,155	5,255	7,200	7,020	6,240	4,680
5/8 or #5	5,115	6,610	11,020	8,135	5,025	8,375	11,160	10,880	9,670	7,255
3/4 or #6	7,565	9,785	16,305	10,235	7,435	12,390	15,840	15,445	13,730	10,295
7/8 or #7	10,445	13,505	22,505	14,130	10,265	17,105	21,600	21,060	18,720	-
1 or #8	13,700	17,715	29,525	18,535	13,465	22,445	28,440	27,730	24,650	-
#9	-	-	-	-	-	-	36,000	35,100	31,200	-
1-1/4 or #10	21,920	28,345	47,240	29,655	21,545	35,905	45,720	44,575	39,625	-

■ - Steel Strength

1. Steel shear design strength according to ACI 318-14 Ch.17 Appendix D, $\phi V_{sa} = \phi \cdot 0.60 \cdot A_{se,V} \cdot f_{uta}$
2. The tabulated steel design strength in shear must be checked against the bond strength/concrete capacity design strength to determine the controlling failure mode, the lowest load level controls.

INSTALLATION INSTRUCTIONS (SOLID BASE MATERIALS)

DRILLING

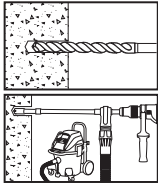

1- Drill a hole into the base material with rotary hammer drill (i.e. percussion drill) and a carbide drill bit to the size and embedment required by the selected steel hardware element (reference installation specifications for threaded rod and reinforcing bar). The tolerances of the carbide drill bits, including hollow bits, must meet ANSI Standard B212.15.

- Precaution: Use suitable eye and skin protection. Avoid inhalation of dust during drilling and/or removal (see dust extraction equipment by DEWALT to minimize dust emission).

- **Note!** In case of standing water in the drilled hole (flooded hole condition), all the water has to be removed from the hole (e.g. vacuum, compressed air, etc.) prior to cleaning.

Drilling in dry base material is recommended when using hollow drill bits (vacuum must be on).

GO TO STEP 3 FOR HOLES DRILLED WITH DUSTX+™ DRILLING AND CLEANING SYSTEM; OTHERWISE GO TO STEP 2A.

HOLE CLEANING DRY (BLOW 4X, BRUSH 4X, BLOW 4X)



2a- Starting from the bottom or back of the anchor hole, blow the hole clean using a compressed air nozzle (min. 90 psi) or a hand pump (supplied by DEWALT) a minimum of four times (4x).

- Use a compressed air nozzle (min. 90 psi) or a hand pump (min. volume 25 fl. oz.) for anchor rod 3/8" to 3/4" diameter or reinforcing bar (rebar) sizes #3 to #6.

- Use a compressed air nozzle (min. 90 psi) for anchor rod 7/8" to 1-1/4" diameter and rebar sizes #7 to #10. A hand pump shall not be used with these anchor sizes.

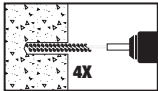

2b- Determine wire brush diameter (see installation specifications) and attach the brush with adaptor to a rotary drill tool or battery screwgun. Brush the hole with the selected wire brush a minimum of four times (4x). A brush extension (supplied by DEWALT, Cat. #08282) should be used for holes drilled deeper than the listed brush length.

- The wire brush diameter should be checked periodically during use. The brush should resist insertion into the drilled hole and come into contact with the sides of the drilled hole. If not the brush is too small and must be replaced.

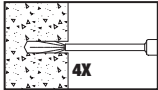

2c- Finally, blow the hole clean again a minimum of four times (4x).

- Use a compressed air nozzle (min. 90 psi) or a hand pump (min. volume 25 fl. oz.) for anchor rod 3/8" to 3/4" diameter or reinforcing bar (rebar) sizes #3 to #6.

- Use a compressed air nozzle (min. 90 psi) for anchor rod 7/8" to 1-1/4" diameter and rebar sizes #7 to #10. A hand pump shall not be used with these anchor sizes.

- When finished the hole should be clean and free of dust, debris, ice, grease, oil or other foreign material.

PREPARING



3- Check adhesive expiration date on cartridge label. Do not use expired product. Review Safety Data Sheet (SDS) before use. Cartridge temperature must be between 23°F - 95°F (-5°C - 35°C) when in use unless otherwise noted. Review gel (working) and cure time table. Consideration should be given to the reduced gel time of the adhesive in warm temperatures.

- Attach a supplied mixing nozzle to the cartridge. Unless otherwise noted do not modify the mixer in any way and make sure the mixing element is inside the nozzle. Load the cartridge into the correct dispensing tool.

- Note: Always use a new mixing nozzle with new cartridges of adhesive and also for all work interruptions exceeding the published working time of the adhesive.

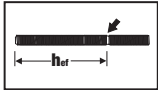

4- Prior to inserting the anchor rod or rebar into the filled bore hole, the position of the embedment depth has to be marked on the anchor

- Verify anchor element is straight and free of surface damage.

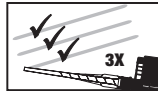

5- Adhesive must be properly mixed to achieve published properties. For new cartridges and nozzles, prior to dispensing adhesive into the drilled hole, separately dispense at least three full strokes of adhesive through the mixing nozzle until the adhesive is a consistent **GRAY** color. Do not attach a used nozzle when changing to a new cartridge.

- Review and note the published working and cure times (see gel time and curing time table) prior to injection of the mixed adhesive into the cleaned anchor hole.

INSTALLATION

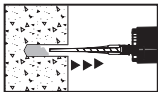

6- Fill the cleaned hole approximately to two-thirds full with mixed adhesive starting from the bottom or back of the anchor hole. Slowly withdraw the mixing nozzle as the hole fills to avoid creating air pockets or voids. If the bottom or back of the anchor hole is not reached with the mixing nozzle only, a plastic extension tube must be used with the mixing nozzle (see reference tables for installation).

- Piston plugs (see installation specifications) must be used with and attached to the mixing nozzle and extension tube for horizontal and overhead installations in concrete with anchor rod 5/8" to 1-1/4" diameter and rebar size #5 to #10. Insert piston plug to the back of the drilled hole and inject as described in the method above. During installation the piston plug will be naturally extruded from the drilled hole by the adhesive pressure.

- **Attention!** Do not install anchors overhead without proper training and installation hardware provided by DEWALT. Contact DEWALT for details prior to use.

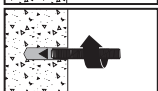
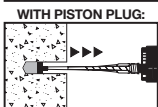

7- The anchor should be free of dirt, grease, oil or other foreign material. Push clean threaded rod or reinforcing bar into the anchor hole while turning slightly to ensure positive distribution of the adhesive until the embedment depth is reached. Observe the gel (working) time.

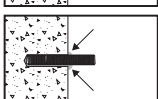

8- Be sure that the anchor is fully seated at the bottom of the hole to the specified embedment. Adhesive must completely fill the annular gap between the anchor and the base material. Protect the anchor element threads from fouling with adhesive. For all installations the rebar must be restrained from movement throughout the specified curing period (as necessary) where necessary through the use of temporary wedges, external supports, or other methods. Minor adjustments to the position of the anchor element may be performed during the gel (working) time only.

CURING AND LOADING

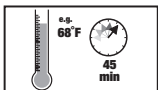

9- Allow the adhesive anchor to cure to the specified full curing time prior to applying any load (reference gel time and curing time table).

- Do not disturb, torque or load the anchor until it is fully cured.



10- After full curing of the adhesive anchor, a fixture can be installed to the anchor and tightened up to the maximum torque (reference gel time and curing table) by using a calibrated torque wrench.

- Take care not to exceed the maximum torque for the selected anchor.

INSTALLATION INSTRUCTIONS (UNREINFORCED MASONRY [URM WALLS] AND HOLLOW BASE MATERIALS)

DRILLING

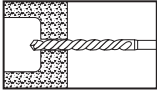

- 1- Drill a hole into the base material with a rotary drill tool to the size and embedment required by the selected screen tube size and steel anchor element (see installation specifications for threaded rod in hollow base material with screen tube supplied by DEWALT). Holes drilled in hollow concrete masonry units may be drilled with a rotary hammer-drill. The tolerances of the drill bit, including hollow drill bits, must meet the requirements of ANSI B212.15.

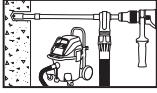

- Precaution: Wear suitable eye and skin protection. Avoid inhalation of dust during drilling and/or removal (see dust extraction by DEWALT to minimize dust emission).

Drilling in dry base materials is recommended when using hollow drill bits (vacuum must be on).

GO TO STEP 3 FOR HOLES DRILLED WITH DUSTX+™ DRILLING AND CLEANING SYSTEM; OTHERWISE GO TO STEP 2A.

HOLE CLEANING (BLOW 2X, BRUSH 2X, BLOW 2X)

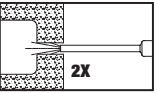

- 2- Starting from the bottom or back of the anchor hole, blow the hole clean with a hand pump (min. volume 25 fl.oz. supplied by DEWALT) or compressed air nozzle a minimum of two times (2x).

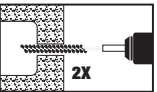

- Determine the wire brush diameter (see installation specifications) and attach the brush with adaptor to a rotary drill tool or battery screw gun. Brush the hole with the selected wire brush a minimum of two times (2x). A brush extension (supplied by DEWALT, Cat #08282) should be used for holes drilled deeper than the listed brush length.

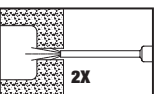

- The wire brush should be checked periodically during use. The brush should resist insertion into the drilled hole and come into contact with the sides of the drilled hole. If not the brush is too small and must be replaced.
- Finally, blow the hole clean again a minimum of two times (2x)
- When finished the hole should be clean and free of dust, debris, ice, grease, oil or other foreign material.

PREPARING



- 3- Check adhesive expiration date on cartridge label. Do not use expired product. Review Safety Data Sheet (SDS) before use. Cartridge temperature must be between 23°F - 95°F (-5°C - 35°C) when in use unless otherwise noted. Review gel (working) time and curing time table. Consideration should be given to the reduced gel (working) time of the adhesive in warm temperatures.

- Attach a supplied mixing nozzle to the cartridge. Unless otherwise noted do not modify the mixer in any way and make sure the mixing element is inside the nozzle. Load the cartridge into the correct dispensing tool.
- Note: Always use a new mixing nozzle with new cartridges of adhesive and also for all work interruptions exceeding the published working time of the adhesive.

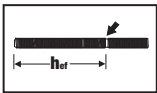

- 4- Prior to inserting the anchor into the filled screen tube, the position of the embedment depth has to be marked on the anchor. Verify anchor element is straight and free of surface damage.

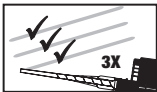

- 5- Adhesive must be properly mixed to achieve published properties. Prior to dispensing adhesive into the drilled hole, separately dispense at least three full strokes of adhesive through the mixing nozzle until the adhesive is a consistent **GRAY** color. Do not attach a used nozzle when changing to a new cartridge.

- Review and note the published working and cure times (see gel time and curing time table) prior to injection of the mixed adhesive into the screen tube.

INSTALLATION

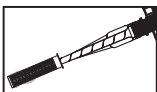

- 6- Select a screen tube of suitable length (supplied by DEWALT). Fill the screen tube full with adhesive starting from the bottom or back of the tube. Slowly withdraw the mixing nozzle as the screen fills to avoid creating air pockets or voids. A plastic extension tube must be used with the mixing nozzle if the back of the screen tube cannot be reached (see reference tables for installation).

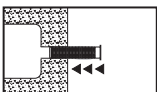

- 7- Insert the screen tube filled with adhesive into the cleaned anchor hole. Inject additional adhesive into the screen tube as necessary to ensure the screen tube is completely filled.

- Note: Overfilling the screen tube is acceptable but not required.

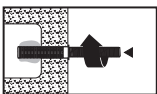

- 8- Prior to inserting the anchor rod into the screen tube inspect it to ensure that it is free of dirt, grease, oil or other foreign material.

- Push the threaded rod into the screen tube while turning slightly to ensure positive distribution of the adhesive until back of the tube is reached.

- Note: In cases where the drilled hole size is larger than specified due to rotary drilling (e.g. an elongated opening), the annular space between the screen tube and the hole at the base material surface must be filled with adhesive.

CURING AND FIXTURE

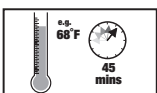

- 9- Allow the adhesive anchor to cure to the specified full curing time prior to applying any load.

- Do not disturb, torque or load the anchor until it is fully cured (see gel time and curing time table).

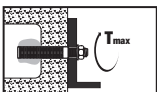

- 10- After full curing of the adhesive anchor, a fixture can be installed to the anchor and tightened up to the maximum torque (see installation specifications for threaded rod in hollow base material) by using a calibrated torque wrench.

- Take care not to exceed the maximum torque for the selected anchor.

REFERENCE TABLES FOR INSTALLATION

Gel (working) Time and Curing Table

Temperature of Base Material		Gel (working) Time	Full Curing Time
°F	°C		
14	-10	90 minutes	24 hours
23	-5	90 minutes	14 hours
32	0	45 minutes	7 hours
41	5	25 minutes	2 hours
50	10	15 minutes	90 minutes
68	20	6 minutes	45 minutes
86	30	4 minutes	25 minutes
95	35	2 minutes	20 minutes
104	40	1.5 minutes	15 minutes

The gel (working) times listed for 32°F to 95°F are also applicable for the temperature of the adhesive and use of mixing nozzles during installation.
For installations in base material temperatures between 14°F and 23°F (-10°C and -5°C) the cartridge temperature must be conditioned to between 68°F and 95°F (20°C - 35°C).

Hole Cleaning Equipment Selection Table for AC100+ Gold^{1,2,3,4}

Threaded Rod Diameter (inch)	Rebar Size (no.)	Drill Bit Diameter (inch)	Overall Brush Length, L (inches)	Steel Wire Brush (Cat. #)	Blowout Tool	Number of Cleaning Actions
Solid Base Material						
3/8	#3	7/16	6-3/4	08284	Hand-pump (Cat #08280) or compressed air nozzle	4x blowing 4x brushing 4x blowing
1/2	-	9/16	6-3/4	08285		
-	#4	5/8	6-3/4	08275		
5/8	#5	11/16	7-7/8	08286		
5/8	#5	3/4	7-7/8	08278		
3/4	#6	7/8	7-7/8	08287		
7/8	#7	1	11-7/8	08288	Compressed air nozzle only	
1	#8	1-1/8	11-7/8	08289		
1-1/4	#9	1-3/8	11-7/8	08290		
-	#10	1-1/2	11-7/8	08291		
Hollow Base Material (with Screen Tube)						
1/4	-	3/8 (SS screen)	6-3/4	08284	Hand pump (Cat# 08280) or compressed air nozzle	2x blowing 2x brushing 2x blowing
1/4	-	1/2 (plastic screen)	6-3/4	08284		
3/8	-	1/2 (SS screen)	6-3/4	08284		
3/8	-	9/16 (plastic screen)	6-3/4	08285		
1/2	#3	5/8 (SS screen)	6-3/4	08275		
1/2	-	3/4 (plastic screen)	7-7/8	08278		
5/8	#4	3/4 (SS screen)	7-7/8	08278		
5/8	-	7/8 (plastic screen)	7-7/8	08287		
3/4	#5	7/8 (SS screen)	7-7/8	08287		
15/16	#6	1 (SS screen)	11-7/8	08288		

1. An SDS-plus adaptor (Cat. #08283) or Jacobs chuck style adaptor (Cat. #08296) is required to attach a steel wire brush to the drill tool.
2. A brush extension (Cat. #08282) must be used for holes drilled deeper than the listed brush length.
3. See ordering information for selection of piston plugs (where applicable).
4. For any case, it must be possible for the steel anchor element to be inserted into the cleaned hole without resistance.

See separate installation details in this section for 'Retrofit Bolt Anchors in URM Walls': threaded Rods and Reinforcing Bars or Rebar Dowel with AC100+ Gold Installed in Unreinforced Masonry Walls with Stainless Steel Screen Tubes.

ORDERING INFORMATION

AC100+ Gold Cartridges

Cat No.	Description	Std. Pack	Std. Carton	Pallet
8478SD	AC100+ Gold 9.5 fl. oz. Quik-Shot	12	36	648
8486SD	AC100+ Gold 11.5 fl. oz. dual cartridge	-	12	540
8490SD	AC100+ Gold 28 fl. oz. dual cartridge	-	8	240

One AC100+ Gold mixing nozzle is packaged with each cartridge.
AC100+ Gold mixing nozzles must be used to ensure complete and proper mixing of the adhesive.



Cartridge System Mixing Nozzles

Cat No.	Description	Std. Pack	Std. Carton
08293	Extra mixing nozzle for AC100+ Gold (10 oz. & 12 oz.)	2	24
08294	Extra mixing nozzle (with an 8" extension) for AC100+ Gold 28 oz.	2	24
08281	Mixing nozzle extension, 8" minimum	2	24
08297	Mixing nozzle extension, 20" long		



Dispensing Tools for Injection Adhesive

Cat No.	Description	Std. Pack	Std. Ctn.
08437	Manual caulking gun for Quik-Shot	1	12
08479	High performance caulking gun for Quik-Shot	1	6
08485	AC100+ Gold high performance manual tool	1	20
08494	AC100+ Gold 28 oz. standard all metal manual tool	1	-
08496	AC100+ Gold 28 oz. pneumatic tool	1	-
DCE595D1	AC100+ Gold 28 oz. 20v battery powered dispensing tool	1	-

Piston Plugs for Adhesive Anchors

Cat. No.	Description	Drill Bit Dia.	Std. Pack	Std. Ctn.
08304	5/8" Plug	5/8"	10	100
08258	11/16" Plug	11/16"	10	100
08259	3/4" Plug	3/4"	10	100
08300	7/8" Plug	7/8"	10	100
08301	1" Plug	1"	10	100
08303	1-1/8" Plug	1-1/8"	10	100
08305	1-3/8" Plug	1-3/8"	10	100
08307	1-1/4" Plug	1-1/4"	10	100
08309	1-1/2" Plug	1-1/2"	10	100

A plastic extension tube (Cat# 08281 or 08297) or equivalent approved by DEWALT must be used with piston plugs.



Hole Cleaning Tools and Accessories

Cat No.	Description	Std. Pack
08284	Wire brush for 7/16" or 1/2" ANSI hole, 6-3/4" length	1
08285	Wire brush for 9/16" ANSI hole, 6-3/4" length	1
08275	Wire brush for 5/8" ANSI hole, 6-3/4" length	1
08286	Wire brush for 11/16" ANSI hole, 7-7/8" length	1
08278	Wire brush for 3/4" ANSI hole, 7-7/8" length	1
08287	Wire brush for 7/8" ANSI hole, 7-7/8" length	1
08288	Wire brush for 1" ANSI hole, 11-7/8" length	1
08289	Wire brush for 1-1/8" ANSI hole, 11-7/8" length	1
08276	Wire brush for 1-1/4" ANSI hole, 11-7/8" length	1
08290	Wire brush for 1-3/8" ANSI hole, 11-7/8" length	1
08291	Wire brush for 1-1/2" ANSI hole, 11-7/8" length	1
08283	SDS-plus adapter for steel brushes	1
08296	Standard drill adapter for steel brushes (e.g. Jacobs Chuck)	1
08282	Steel brush extension, 12" length	1
08280	Hand pump/dust blower (25 ft. oz. cylinder volume)	1
08292	Air compressor nozzle with extension, 18" length	1
52073	Adhesive cleaning kit, includes 4 wire brushes (08284, 08285, 08286, 08287), steel brush extension (08282), SDS-plus adapter (08283), standard drill adapter (08296), hand pump/dust blower (08280), gloves and safety glasses	1

Stainless Steel Screen Tubes

Cat. No.	Description	Drill Bit Dia.	Std. Pack
07960	1/4" x 2" Screen Tube	3/8"	25
07862	1/4" x 6" Screen Tube*	3/8"	25
07864	1/4" x 8" Screen Tube*	3/8"	25
07856	3/8" x 2" Screen Tube	1/2"	25
07961	3/8" x 3-1/2" Screen Tube	1/2"	25
07962	3/8" x 6" Screen Tube*	1/2"	25
07963	3/8" x 8" Screen Tube*	1/2"	25
07964	3/8" x 10" Screen Tube*	1/2"	25
07857	1/2" x 2" Screen Tube	5/8"	25
07965	1/2" x 3-1/2" Screen Tube	5/8"	25
07966	1/2" x 6" Screen Tube*	5/8"	25
07967	1/2" x 8" Screen Tube*	5/8"	25
07968	1/2" x 10" Screen Tube*	5/8"	25
07858	5/8" x 2" Screen Tube	3/4"	25
07969	5/8" x 4-1/2" Screen Tube	3/4"	20
07970	5/8" x 6" Screen Tube	3/4"	20
07971	5/8" x 8" Screen Tube*	3/4"	20
07972	5/8" x 10" Screen Tube*	3/4"	20
07859	3/4" x 2" Screen Tube	7/8"	25
07855	15/16" x 2" Screen Tube	1"	25
07865	15/16" x 8" Screen Tube	1"	10
07867	15/16" x 13" Screen Tube	1"	10

Screen tubes are made from a 300 series stainless steel. The nominal diameter of the screen listed indicates the matching rod diameter (except for the 15/16" screen tubes, see next note). 15/16" screen tubes can accept 3/4" diameter threaded rods and #4, #5 or #6 reinforcing bars for unreinforced masonry wall applications (URM). See separate installation details and information in this section for 'Retrofit Bolt Anchors in URM Walls'.

*Includes extension tubing.

Plastic Screen Tubes



Cat. No.	Description	Drill Bit Dia.	Std. Pack
08310	3/8" x 3-1/2" Plastic Screen	9/16"	25
08311	3/8" x 6" Plastic Screen	9/16"	25
08313	3/8" x 8" Plastic Screen	9/16"	25
08315	1/2" x 3-1/2" Plastic Screen	3/4"	25
08317	1/2" x 6" Plastic Screen	3/4"	25
08321	5/8" x 6" Plastic Screen	7/8"	25
08323	3/4" x 6" Plastic Screen	1"	10



SDS Max 4-Cutter Carbide Drill Bits

Cat. No.	Diameter	Usable Length	Overall Length
DW5806	5/8"	8"	13-1/2"
DW5809	5/8"	16"	21-1/2"
DW5807	5/8"	31"	36"
DW5808	11/16"	16"	21-1/2"
DW5810	3/4"	8"	13-1/2"
DW5812	3/4"	16"	21-1/2"
DW5813	3/4"	31"	36"
DW5814	13/16"	16"	21-1/2"
DW5815	7/8"	8"	13-1/2"
DW5816	7/8"	16"	21-1/2"
DW5851	7/8"	31"	36"
DW5817	27/32"	16"	21-1/2"
DW5818	1"	8"	13-1/2"
DW5819	1"	16"	22-1/2"
DW5852	1"	24"	29"
DW5820	1"	31"	36"
DW5821	1-1/8"	10"	15"
DW5822	1-1/8"	18"	22-1/2"
DW5853	1-1/8"	24"	29"
DW5854	1-1/8"	31"	36"
DW5824	1-1/4"	10"	15"
DW5825	1-1/4"	18"	22-1/2"

Dust Extraction

Cat. No.	Description
DWV012	10 Gallon Wet/Dry Hepa/Rrp Dust Extractor DWV9402 Fleece bag (5 pack) for DEWALT dust extractors DWV9316 Replacement Anti-Static Hose DWV9320 Replacement HEPA Filter Set (Type 1)
DWH050K	Dust Extraction with two interchangeable drilling heads
DCB1800B	1800 Watt Portable Power Station & Parallel Battery Charger Bare Unit

SDS+ Full Head Carbide Drill Bits



Cat. No.	Diameter	Usable Length	Overall Length
DW5502	3/16"	2"	4-1/2"
DW5503	3/16"	4"	6-1/2"
DW5504	3/16"	5"	8-1/2"
DW5506	3/16"	10"	12"
DW5512	7/32"	8"	10"
DW5517	1/4"	4"	6"
DW5518	1/4"	6"	8-1/2"
DW55200	1/4"	10"	12"
DW5521	1/4"	12"	14"
DW5524	5/16"	4"	6"
DW5526	5/16"	10"	12"
DW5527	3/8"	4"	6-1/2"
DW5529	3/8"	8"	10"
DW55300	3/8"	10"	12"
DW5531	3/8"	16"	18"
DW5537	1/2"	4"	6"
DW5538	1/2"	8"	10-1/2"
DW5539	1/2"	10"	12"
DW5540	1/2"	16"	18"



SDS+ 4-Cutter Carbide Drill Bits

Cat. No.	Diameter	Usable Length	Overall Length
DW5471	5/8"	8"	10"
DW5472	5/8"	16"	18"
DW5474	3/4"	8"	10"
DW5475	3/4"	16"	18"
DW5477	7/8"	8"	10"
DW5478	7/8"	16"	18"
DW5479	1"	8"	10"
DW5480	1"	16"	18"
DW5481	1-1/8"	8"	10"
DW5482	1-1/8"	6"	18"



Hollow Drill Bits

	Cat. No.	Diameter	Overall Length	Usable Length	Recommended Hammer
SDS+	DWA54012	1/2"	14-1/2"	9-3/4"	DCH133 / DCH273 / DCH293
	DWA54916	9/16"	14-1/2"	9-3/4"	DCH133 / DCH273 / DCH293
	DWA54058	5/8"	14-1/2"	9-3/4"	DCH133 / DCH273 / DCH293
	DWA54034	3/4"	14-1/2"	9-3/4"	DCH133 / DCH273 / DCH293
SDS Max	DWA58058	5/8"	23-5/8"	15-3/4"	DCH481 / D25603K
	DWA58958	5/8"	47-1/4"	39-3/8"	DCH481 / D25603K
	DWA58116	11/16"	24-3/4"	15-3/4"	DCH481 / D25603K
	DWA58034	3/4"	23-5/8"	15-3/4"	DCH481 / D25603K
	DWA58934	3/4"	47-1/4"	39-3/8"	DCH481 / D25603K
	DWA58078	7/8"	23-5/8"	15-3/4"	DCH481 / D25603K
	DWA58001	1"	23-5/8"	15-3/4"	DCH481 / D25603K
	DWA58901	1"	47-1/4"	39-3/8"	DCH481 / D25603K
	DWA58118	1-1/8"	23-5/8"	15-3/4"	DCH481 / D25603K
	DWA58918	1-1/8"	47-1/4"	39-3/8"	DCH481 / D25603K
	DWA58114	1-1/4"	47-1/4"	39-3/8"	DCH481 / D25603K
	DWA58138	1-3/8"	47-1/4"	39-3/8"	DCH481 / D25603K
	DWA58112	1-1/2"	47-1/4"	39-3/8"	DCH481 / D25603K

