

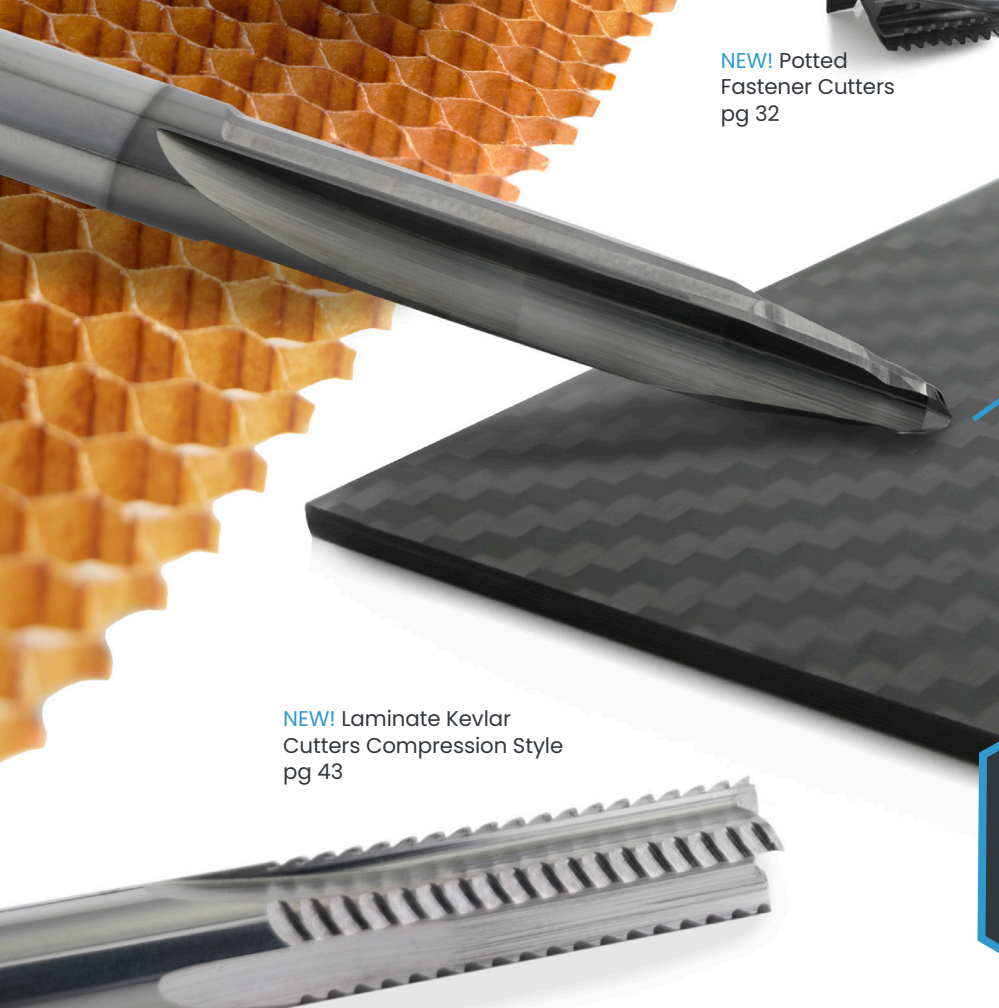

NEW! Potted
Fastener Cutters
pg 32



NEW! CFRP Drills pg 56

Advanced Geometry for
Unmatched CFRP Drilling

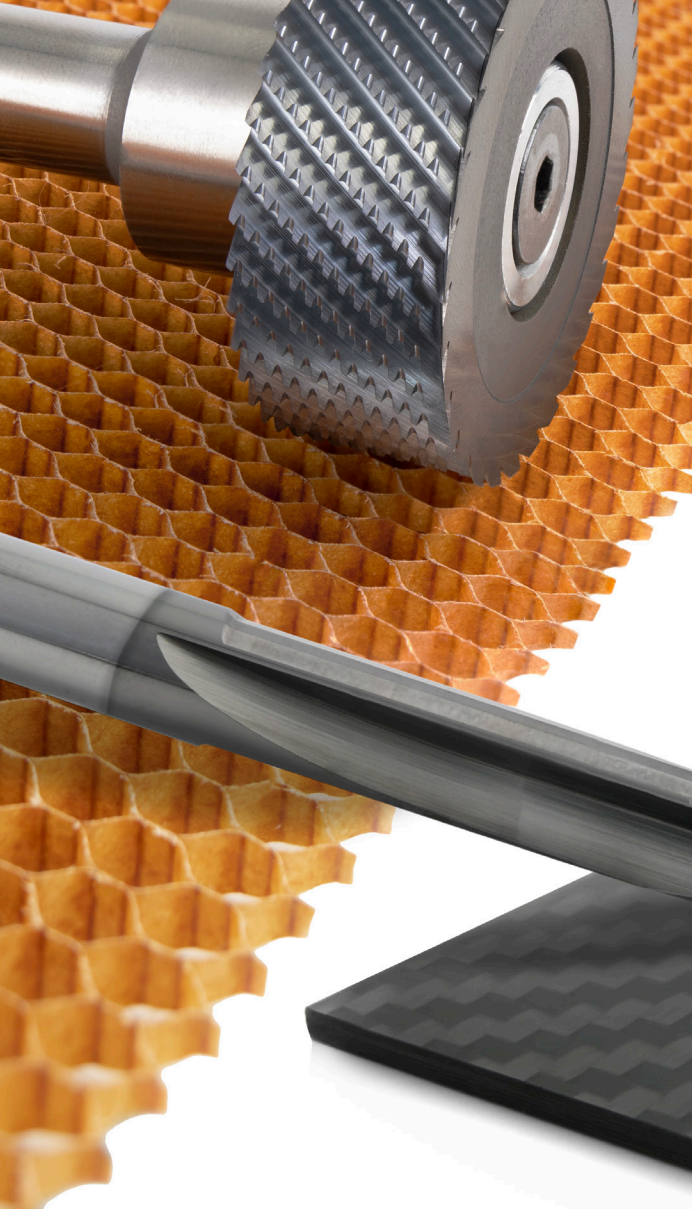

NEW! Laminate Kevlar
Cutters Compression Style
pg 43



450+ New
Tools with 7
Brand New
Product Lines



COREHOG®

Innovative Tools for Innovative Materials



Delivering Advanced Composite Cutting Tools

Composite machining presents a unique set of challenges. At CoreHog, we've risen to the occasion. Our tools are on the forefront of technology, exhibiting the most modern geometries available for the machining of composite, CFRP, and honeycomb core materials.

Taking You Further at the Spindle

At CoreHog, we pride ourselves on our ability to elevate your composite cutting skill. We design, engineer, and manufacture our products specifically to avoid common composite cutting woes, such as delamination and push-out, uncut fibers, and tear-out.

Making You an Industry Leader

We're proud of our loyal customers – learning of their successes is what keeps us fueled. Machinists who choose CoreHog are at the pinnacle of their craft, and consistently win in markets ranging from Aerospace, Space Systems, Defense Systems, Auto Racing, and Naval Technologies.



Harvey Performance Company combines the leading Harvey Tool, Helical Solutions, Micro 100, Titan USA, and CoreHog brands to provide world class tooling, unmatched service, and innovative solutions that increase productivity for our customers.



Think Harvey Tool First

More than 28,000 miniature and specialty end mills. Ship today, in your machine tomorrow.

HARVEY PERFORMANCE
COMPANY



Let Helical Impress You

Material-optimized high performance carbide end mills. Run faster, push harder, machine smarter.



Make More with Micro 100

Exceptional quality turning tools designed for durability and performance in a range of difficult-to-machine materials.



Trust in Titan USA

Broad assortment of quality, fully stocked cutting tools at exceptional value.







Innovative Tools for Innovative Materials

The industry's most innovative and advanced composite and honeycomb core cutting tools.

Experience the NEW corehog.com

Did you know that you can place a CoreHog order directly to your distributor from our website? After creating your corehog.com account, you're able to build and send "shopping carts" directly to your participating distributor to order. Learn more on page 74.

-  Shopping Cart
-  Check Stock
-  Table Filtering
-  Smart-Search

MILLING

Composites Honeycomb **8**



Composites Sandwich Panel **28**

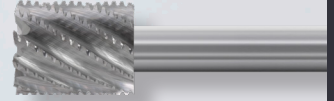

Composites Laminates **33**



Composites Filled **46**

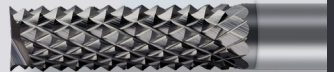

Plastics Unfilled **51**

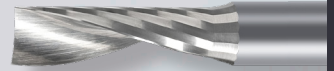

DRILLING

Composites Laminates & Filled **55**



Innovative Tools for Innovative Materials

NEW

450+ NEW Tools Released



CFRP Routers
Compression
Style
pg 39

CFRP Drills
First of Its Kind in
the Composite
Cutting Industry
pg 56

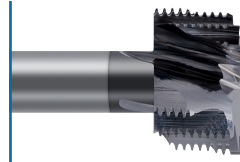

Potted
Fastener
Cutters
pg 32

Miniature
Drills
pg 55



Miniature Diamond
Coated End Mills
Square on pg 46
Ball on pg 47



Laminate
Kevlar
Cutters
pg 43



Coatings Chart

	DLC	CVD	PCD	ZrN
	Diamond-Like coating has extremely sharp edges, improving lubricity and wear resistance in low temperature threshold applications of non-ferrous materials.	True Crystalline Diamond coating is grown directly onto a cutting tool, dramatically improving hardness, abrasion resistance, and feed rates in non-ferrous machining applications.	Thick diamond layer brazed onto solid carbide body provides outstanding micro hardness and abrasion resistance in low temperature threshold applications of non-ferrous materials.	Provides higher hardness, lubricity, and abrasion resistance over uncoated tooling when machining a variety of non-ferrous materials.
Max. Working Temp.	600° F	1,100° F	1,100° F	1,100° F
Microhardness (HV 0.05)	2,400 (24 GPa)	8,973 - 9,993 (88 - 98 GPa)	8,973 - 9,993 (88 - 98 GPa)	2,243 (22 GPa)
Coefficient of Friction	.05 - .1	.05 - .30	.05 - .20	.40
Coating Thickness	1 - 4 µm	3 - 18 µm	.010" - .030" Solid PCD Layer	2 - 5 µm
Structure	Mono-Layer	True Crystalline CVD Multi-Layer	Polycrystalline Diamond	Mono-Layer
Coating Color	Black	Gray	Gray / Black	Light Gold / Champagne

	TiN	TiCN	TiAlN
	High hardness general purpose coating improves overall tool life and lubricity when machining ferrous materials and in applications that do not generate excessive heat.	Maintains high surface hardness and increases abrasion wear resistance to improve overall tool life in lower temperature applications.	High heat and wear resistant coating that maintains high surface hardness at elevated temperatures for improved tool life and faster feed rates when machining ferrous materials.
Max. Working Temp.	1,000° F	750° F	1,300° F
Microhardness (HV 0.05)	2,400 (24 GPa)	3,500 (34 GPa)	3,400 - 3,600 (24-36 GPa)
Coefficient of Friction	.40	.25	.60
Coating Thickness	2 - 5 µm	1 - 4 µm	1 - 4 µm
Structure	Mono-Layer	Mono-Layer	Multi-Layer
Coating Color	Gold	Gray / Silver	Dark Gray / Black

Increase Cutting Tool Performance and Wear

Increase cutting tool performance in wear resistance, abrasion prevention, corrosion, and oxidation at high temperatures.

8 MILLING

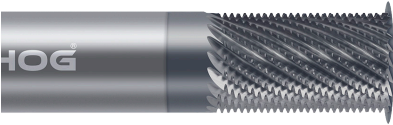

Finishing Core Tools Medium Assembly - begins pg 15



Rebating Cutters Assembly begins pg 30

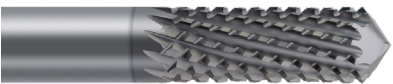

CFRP Routers begins pg 33

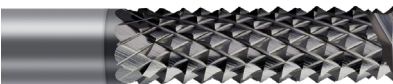

Diamond Cut Routers begins pg 48

Composites - Honeycomb

Roughing Core Tools	8
Finishing Core Tools - Small	13
Finishing Core Tools - Medium NEW ITEMS	15
Finishing Core Tools - Large NEW ITEMS	17
Valve Stem Cutters	21
Wall Finishing Tools NEW ITEMS	25

Composites - Sandwich Panel

Sandwich Panel Cutters	28
Rebating Cutters NEW ITEMS	29
Potted Fastener Cutters NEW	32

Composites - Laminates

CFRP Routers NEW	33
CFRP Max Routers	40
Laminate Kevlar Cutters NEW	43
PCD Diamond End Mills	44

Composites - Filled

Miniature Diamond Coated End Mills NEW	46
Diamond Cut Routers	48

Plastics - Unfilled

Plastic Cutters - Single Flute	51
Plastic Cutters - 2 Flute	52

55 DRILLING



CFRP Drills pg 56

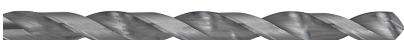

8 Facet Drill pg 62

Composites - Laminates & Filled

Miniature Drills NEW	55
CFRP Drills NEW	56
Helical Step Drills NEW ITEMS	58
Tapered Drill Reamers NEW ITEMS	60
8 Facet Drills NEW ITEMS	62
Dagger Drills NEW ITEMS	66
Countersinks	68

CoreHog's assembly style tooling allows for the selection of tools designed for specific materials, densities, and manufacturing styles. Different configurations increase efficiency, decrease costs, and provide you with machining flexibility.

13 Finishing Core Tools Small



Optimized for machining in small closed features, such as pockets, joggles, and closed walls, these assembly style tools are engineered for the superior finishing of honeycomb core materials.



Small CoreHogger (Optional)

Small Coreslicer

Small Coreslicer Edge Options



15 Finishing Core Tools Medium



Designed for finishing honeycomb core materials, this assembly style CNC tooling is engineered for shaping smaller complex surfaces, bevels, and external radii.



Medium CoreHogger

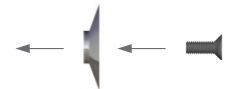

Medium Coreslicer

Screw

Medium Coreslicer Edge Options



17 Finishing Core Tools Large



Designed to vastly reduce cycle times while finishing honeycomb core materials, this assembly style tooling removes large volumes of material quickly, while providing excellent surface finish and keeping tool pressure and heat low.

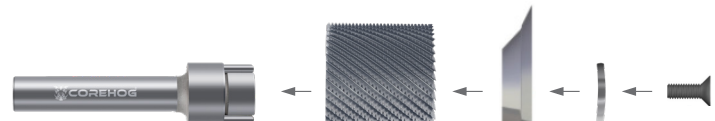

Arbor

Large CoreHogger

Large Coreslicer

Washer* Screw*

*washer and screw included with arbor

Large Coreslicer Edge Options

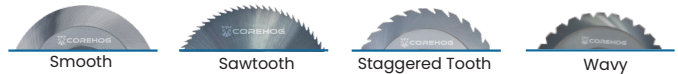

22 Valve Stem Cutters



Assembly tooling engineered for machining honeycomb core materials and finishing thin features such as bevels and knife edge parts.



Arbor

Valve Stem Slicer

Screw

Valve Stem Cutter - Slicer Edge Options



25 Wall Finishing Tools
Hollow Cutters



Leave a pristine finish on vertical and closed pocket walls of honeycomb core materials with CoreHog Hollow Cutters, available in solid carbide or high speed steel options.

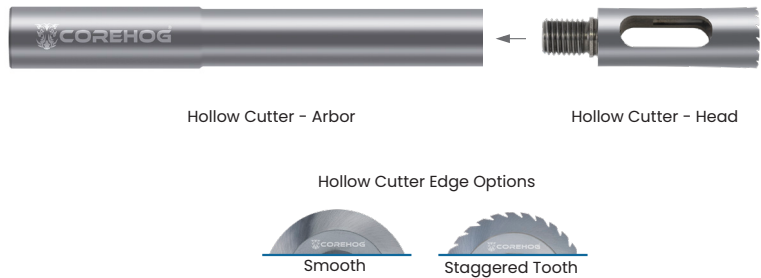

30 Rebating Cutters



The unique design of this modular-style tooling reduces setups, cost per cutter, and allows for flexibility with varying sandwich panel configurations.

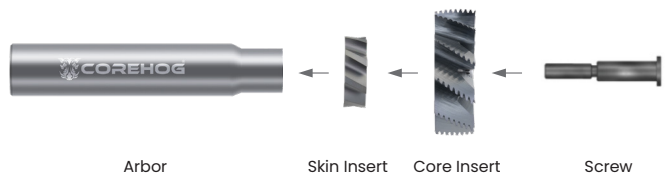

Coreslicer Edge Options

CoreHog's offerings of Smooth, Staggered Tooth, Sawtooth, and Wavy Coreslicers are each specially engineered to provide flag-free finishes and outstanding tool life in the materials and densities for which they are optimized. See the chart below to identify which edge option is best for your application.

Smooth	Staggered Tooth	Sawtooth	Wavy
Designed for all densities of Kevlar® and Nomex® and lighter density aluminum core of 5 pounds or less.	Engineered for medium density aluminum core weighing between 6 and 8 pounds.	Designed for machining heavier density Aluminum core weighing over 8 pounds.	Engineered to machine mixed density honeycomb core materials with hard epoxied bond lines.

Roughing Core Tools

CoreHoggers - Square

- Designed for increased productivity and increased MRR when roughing high density honeycomb core materials
- Used for bulk material removal of honeycomb composite materials including Nomex®, Kevlar®, phenolic, and glass
- Provides excellent performance when roughing and finishing foam materials like Rohacell®, poly foam, and Styrofoam
- Complex geometry reduces tool pressure by utilizing sharp sheering action which results in less part movement and increased speeds & feeds
- Center cutting
- ZrN coating offers higher hardness and added lubricity for maximum performance
- Solid carbide
- Precision manufactured in the USA

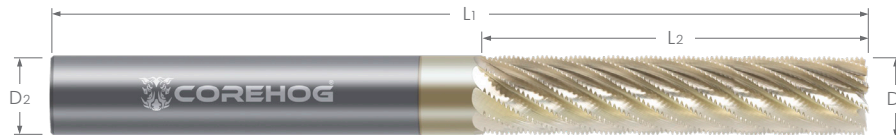

Diameter D ₁	Length of Cut L ₂	Shank Diameter D ₂	Overall Length L ₁	Flutes	ZrN Coated	
					Tool #	Price
.2500	1.250	.2500	2.500	8	C12463	93.40
.2500	1.250	.2500	3.000	8	C61211	103.30
.2500	1.250	.2500	4.000	8	C13568	116.60
.2500	2.750	.2500	6.000	8	C93954	135.70
.3750	2.000	.3750	4.000	8	C21583	151.80
.5000	2.000	.5000	4.000	8	C61071	164.10
.5000	3.000	.5000	6.000	8	C93134	198.50
16 mm	50.8 mm	16 mm	110 mm	10	C42950	230.50
.7500	2.000	.7500	4.000	10	C99519	245.00
.7500	3.000	.7500	6.000	10	C84370	268.50
.7500	4.000	.7500	8.000	10	C62278	383.00
20 mm	80 mm	20 mm	125 mm	10	C68953	265.00
1.0000	2.000	1.0000	4.000	10	C20991	312.00
1.0000	3.000	1.0000	6.000	10	C84163	354.00

Roughing Core Tools CoreHoggers - Square - Reduced Shank

Roughing Core Tools

- Large diameter design for increased productivity and increased MRR when cutting honeycomb core materials
- Used for bulk material removal of honeycomb composite materials including Nomex®, Kevlar®, phenolic, and glass
- Provides excellent performance when roughing and finishing foam materials like Rohacell®, poly foam, and Styrofoam
- Complex geometry reduces tool pressure by utilizing sharp sheering action which results in less part movement and increased speeds & feeds
- End cutting
- TiCN coating for extended tool life and improved wear resistance
- Precision manufactured in the USA

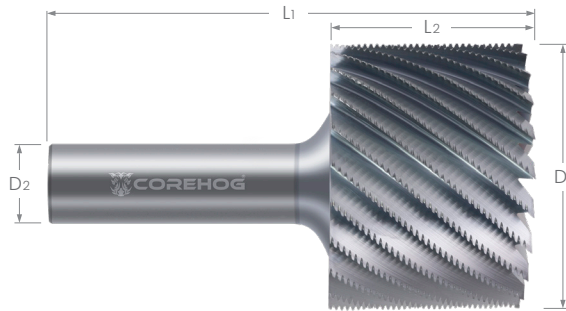

Diameter D ₁	Length of Cut L ₂	Shank Diameter D ₂	Overall Length L ₁	Substrate	Flutes	TiCN Coated	
						Tool #	Price
2.5000	1.875	.7500	4.500	high speed steel	22	C26619	823.80
2.5000	1.875	.7500	4.500	carbide	22	C62908	1,112.40

Roughing Core Tools CoreHoggers - Square for Light Density Core

- Designed for increased productivity and increased MRR when cutting light density honeycomb core materials
- Used for bulk material removal of honeycomb composite materials including Nomex®, Kevlar®, phenolic, and glass
- Provides excellent performance when roughing and finishing foam materials like Rohacell®, poly foam, and Styrofoam
- Center cutting
- ZrN coating offers higher hardness and added lubricity for maximum performance
- Solid carbide
- Precision manufactured in the USA

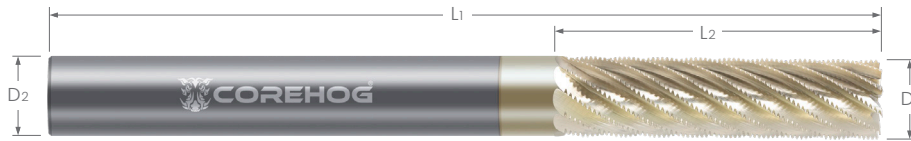

Diameter D1	Length of Cut L2	Shank Diameter D2	Overall Length L1	Flutes	ZrN Coated	
					Tool #	Price
.2500	1.250	.2500	2.500	6	C65069	93.40
.2500	1.250	.2500	4.000	6	C51558	116.60
.5000	2.000	.5000	4.000	10	C61225	164.10
.7500	2.000	.7500	4.000	10	C21033	245.00
.7500	3.000	.7500	6.000	10	C37889	268.00

Download Speeds & Feeds Charts For Every CoreHog Cutting Tool

corehog.com

Roughing Core Tools CoreHoggers - Ball

Roughing Core Tools

- Designed for increased productivity and increased MRR when roughing high density honeycomb core materials
- Ball end profile optimized for shaping and roughing complex surfaces
- Used for bulk material removal of honeycomb composite materials including Nomex®, Kevlar®, phenolic, and glass
- Provides excellent performance when roughing and finishing foam materials like Rohacell®, poly foam, and Styrofoam
- Center cutting
- ZrN coating offers higher hardness and added lubricity for maximum performance
- Solid carbide
- Precision manufactured in the USA

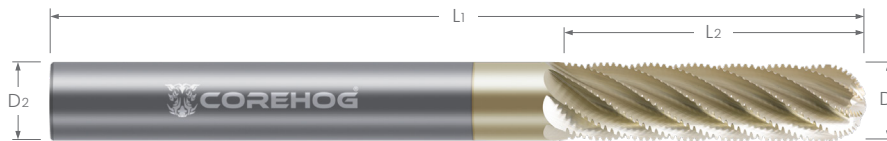

Diameter D1	Length of Cut L2	Shank Diameter D2	Overall Length L1	Flutes	ZrN Coated	
					Tool #	Price
.2500	1.250	.2500	2.500	8	C37430	96.50
.2500	1.250	.2500	3.000	8	C16770	106.20
.2500	1.375	.2500	4.000	8	C11348	120.10
.2500	1.375	.2500	6.000	8	C60420	137.50
.3750	2.000	.3750	4.000	8	C70972	156.20
.5000	2.000	.5000	4.000	8	C28059	171.20
.5000	3.000	.5000	6.000	8	C95202	220.00
16 mm	50.8 mm	.630	110 mm	10	C41998	226.00
.7500	2.000	.7500	4.000	10	C69424	273.10
.7500	3.000	.7500	6.000	10	C50318	314.40
.7500	3.000	.7500	8.000	10	C96800	402.00
20 mm	80 mm	.787	125 mm	10	C59471	281.50
1.0000	2.000	1.0000	4.000	10	C34824	338.00
1.0000	3.000	1.0000	6.000	10	C90082	375.00



Roughing Core Tools CoreHoggers - Ball - Reduced Shank

- Large diameter design for increased productivity and increased MRR when cutting honeycomb core materials
- Ball end profile optimized for shaping and roughing surfaces
- Used for bulk material removal of honeycomb composite materials including Nomex®, Kevlar®, phenolic, and glass
- Provides excellent performance when roughing and finishing foam materials like Rohacell®, poly foam, and Styrofoam
- TiCN coating for extended tool life and improved wear resistance
- Precision manufactured in the USA

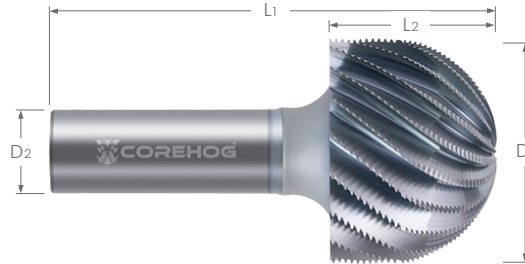

Diameter D1	Length of Cut L2	Shank Diameter D2	Overall Length L1	Substrate	Flutes	End Style	TiCN Coated	
							Tool #	Price
2.0000	1.500	.7500	4.000	high speed steel	18	end cutting	C41016	882.00
2.0000	1.500	.7500	4.000	carbide	18	center cutting	C42897	1,039.00

Finishing Core Tools Small Coreslicers

- Engineered for the superior finishing of honeycomb core materials
- Optimized for reaching into small, closed features such as pockets, joggles, and closed walls
- Pair with a Small CoreHogger for increased performance
- Whistle notch for Small CoreHogger assembly set screw
- TiCN coating for extended tool life and improved wear resistance
- Solid carbide
- Precision manufactured in the USA

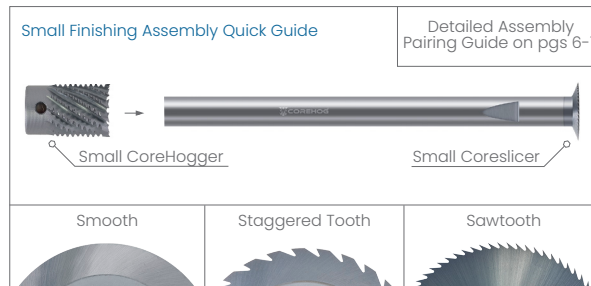

Diameter D1	Edge Type	Shank Diameter D2	Overall Length L1	Flutes	Assembly Size Pairing	TiCN Coated	
						Tool #	Price
.1960 (5 mm)	Smooth	.1180 (3 mm)	1.417 (36 mm)	-	-	C39016*	101.60
.3930 (10 mm)	Smooth	.1960 (5 mm)	4.000	-	.393	C37473	104.20
.3930 (10 mm)	Staggered Tooth	.1960 (5 mm)	4.000	14	.393	C60175	112.00
.3930 (10 mm)	Sawtooth	.1960 (5 mm)	4.000	30	.393	C68738	118.00
.5000	Smooth	.2500	4.000	-	.500	C24361	108.00
.5000	Staggered Tooth	.2500	4.000	20	.500	C16343	119.00
.5000	Sawtooth	.2500	4.000	45	.500	C27014	124.00

* Coreslicer designed with no whistle notch for independent use without CoreHogger.

Finishing Core Tools Small CoreHoggers

- Must be paired with Small Coreslicer for use. For proper pairing, reference "Assembly Pairing Guide"
- Eliminates risk of material wrapping around the spindle by disintegrating them as they approach the face of the slicer
- Long reach design optimized for reaching into small, closed features such as pockets, joggles, and closed walls

- TiCN coating for extended tool life and improved wear resistance
- High speed steel
- Precision manufactured in the USA

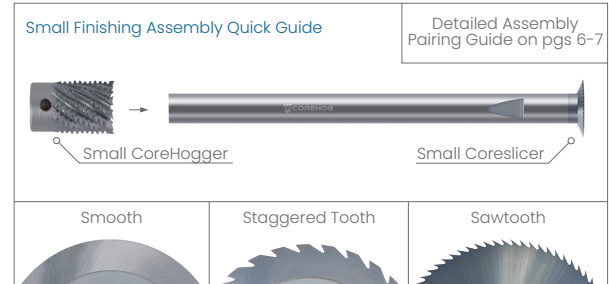
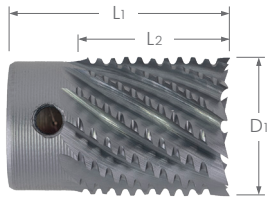

Diameter D1	Length of Cut L2	Overall Length L1	Assembly Size Pairing	TiCN Coated	
				Tool #	Price
.3500	.500	.750	.393	C74686	113.00
.4750	.500	.750	.500	C81725	113.00

Finishing Core Tools - Small

Find an Authorized CoreHog Distributor in Your State or Province and Start Ordering Today

corehog.com

NEW ITEMS

**Finishing Core Tools
Medium Coreslicers**

- Must be paired with Medium CoreHogger for use. For proper pairing, reference "Assembly Size Pairing" below
- Engineered for finishing smaller parts and features of honeycomb core materials
- Stocked in different edge types to provide excellent finishes in Aluminum, Nomex®, and Kevlar® cores
- DLC coating for improved lubricity and wear resistance
- Solid carbide
- Precision manufactured in the USA

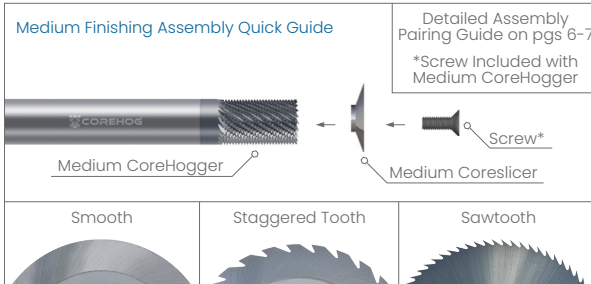

NEW!
NEW!

Diameter D ₁	Edge Type	Flutes	Assembly Size Pairing	DLC Coated	
				Tool #	Price
.5000	Smooth	-	.500	C81787	57.50
.5000	Staggered Tooth	20	.500	C44201	71.50
.5000	Sawtooth	45	.500	C57739	71.50
.7500	Smooth	-	.750	C36226	87.40
.7500	Staggered Tooth	36	.750	C59966	98.70
.7500	Sawtooth	60	.750	C15072	98.70
1.0000	Smooth	-	1.000	C12789	101.20
1.0000	Staggered Tooth	40	1.000	C11921	115.60
1.0000	Sawtooth	65	1.000	C53187	115.60

Finishing Core Tools - Medium

Finishing Core Tools Medium CoreHoggers

- Must be paired with Medium Coreslicer for use. For proper pairing, reference "Assembly Size Pairing" below
- Optimized for shaping smaller complex surfaces, bevels, and external radii in honeycomb core materials
- Solid carbide versions available for superior tool life
- High speed steel
- TiCN coating for extended tool life and improved wear resistance
- Precision manufactured in the USA

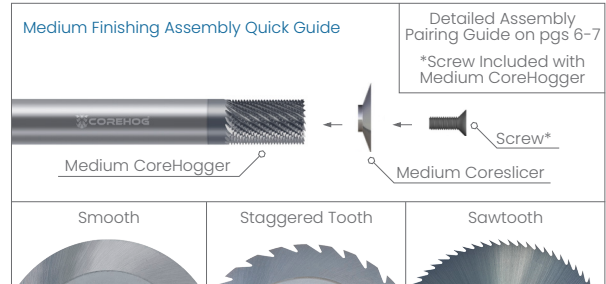

Diameter D ₁	Length of Cut L ₂	Shank Diameter D ₂	Overall Length L ₁	Flutes	Assembly Size Pairing	Uncoated		TiCN Coated	
						Tool #	Price	Tool #	Price
.4720 (12 mm)	1.300	.3750	3.300	10	.500			C32428	169.50
16 mm	30 mm	16 mm	120 mm	20	.750 / 1.000	C51776*	254.50		
.6690 (17 mm)	1.000	.3750	3.000	25	.750 / 1.000			C23037	233.00
.6690 (17 mm)	1.300	.5000	3.500	25	.750 / 1.000			C38452	237.00
.6690 (17 mm)	1.300	.5000	4.750	25	.750 / 1.000			C20657	245.00
.8750 (7/8)	1.500	.5000	3.500	25	1.000			C53955	265.00
.8750 (7/8)	1.300	.5000	4.000	25	1.000	C11495*	400.70		

* Solid carbide

NEW ITEMS

**Finishing Core Tools
Large Coreslicers**

- Must be paired with Large CoreHogger and Arbor for use. For proper pairing, reference "Assembly Size Pairing" below
- Designed to finish large surface area parts in honeycomb core materials
- DLC coating for improved lubricity and wear resistance
- Custom formulated carbide for increased edge retention
- Precision manufactured in the USA

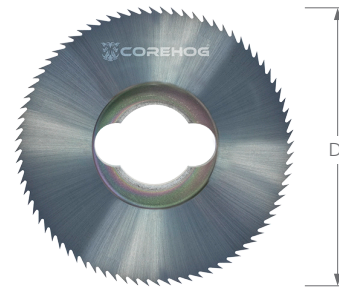
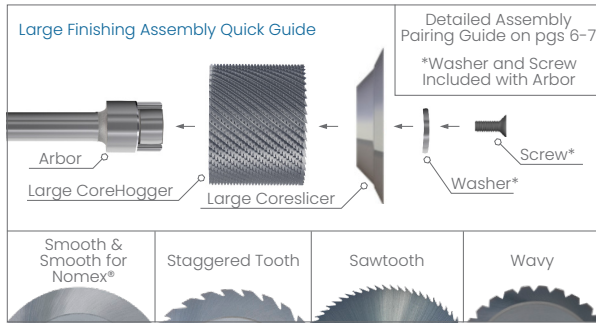

	Diameter D ₁	Edge Type	Flutes	Assembly Size Pairing	DLC Coated	
					Tool #	Price
NEW!	1.5000	Smooth	-	1.500	C01135	201.00
NEW!	1.5000	Smooth for Nomex	-	1.500	C49054	201.00
NEW!	1.5000	Staggered Tooth	40	1.500	C19119	223.20
NEW!	1.5000	Sawtooth	75	1.500	C21919	223.20
NEW!	1.5000	Wavy	25	1.500	C88623	223.20
	2.0000	Smooth	-	2.000	C12149	224.80
	2.0000	Smooth for Nomex	-	2.000	C44070	224.80
	2.0000	Staggered Tooth	40	2.000	C40544	234.90
	2.0000	Sawtooth	90	2.000	C37261	234.90
	2.0000	Wavy	30	2.000	C52001	234.90
	3.0000	Smooth	-	3.000	C64415	335.60
	3.0000	Smooth for Nomex	-	3.000	C12028	335.60
	3.0000	Staggered Tooth	60	3.000	C54747	373.50
	3.0000	Sawtooth	110	3.000	C58561	373.50
	3.0000	Wavy	40	3.000	C19254	373.50
	45 mm	Smooth	-	45 mm	C84541	212.90
	45 mm	Smooth for Nomex	-	45 mm	C99863	212.90
	45 mm	Staggered Tooth	30	45 mm	C25382	229.40
	45 mm	Sawtooth	70	45 mm	C87837	229.40
	45 mm	Wavy	35	45 mm	C86059	229.40
	63 mm	Smooth	-	63 mm (A) / 63 mm (B)	C55856	272.10
	63 mm	Smooth for Nomex	-	63 mm (A) / 63 mm (B)	C70889	272.10
	63 mm	Staggered Tooth	40	63 mm (A) / 63 mm (B)	C85026	297.10
	63 mm	Sawtooth	110	63 mm (A) / 63 mm (B)	C70694	297.10
	63 mm	Wavy	35	63 mm (A) / 63 mm (B)	C20615	297.10

Finishing Core Tools - Large

Finishing Core Tools Large CoreHoggers - Carbide

NEW ITEMS

- Must be paired with Large Coreslicer and Arbor for use. For proper pairing, reference "Assembly Size Pairing" below
- Optimized for large volume material removal of honeycomb core materials
- Standard 40° helix

- TiCN coating for extended tool life and improved wear resistance
- Solid carbide
- Precision manufactured in the USA

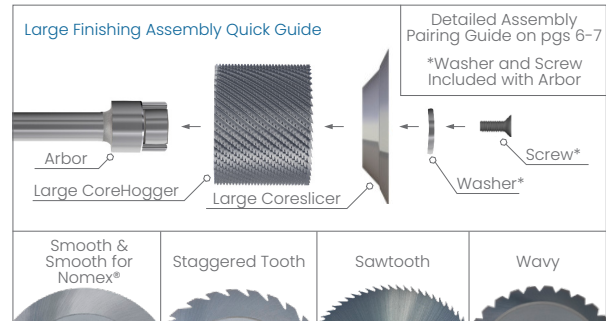
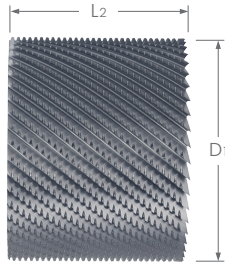

Diameter D1	Length of Cut L2	Assembly Size Pairing	Uncoated		TiCN Coated		
			Tool #	Price	Tool #	Price	
1.4700	.630	45 mm	C57005	450.00			NEW!
1.4700	1.125	45 mm	C22238	455.00			NEW!
44 mm	.630	45 mm	C21741	465.00			
44 mm	1.250	45 mm	C23293	475.00			NEW!
1.9500	.750	2.000	C78723	495.00			
1.9500	1.500	2.000	C24404	530.00	C52278	550.00	NEW!
61.50 mm	.700	63 mm (A)	C16317	505.00			
61.50 mm	1.200	63 mm (B)	C42917	682.00			

Finishing Core Tools - Large

NEW ITEMS

**Finishing Core Tools
Large CoreHoggers - Powdered Metal**

- Must be paired with Large Coreslicer and Arbor for use. For proper pairing, reference "Assembly Size Pairing" below
- Optimized for large volume material removal of honeycomb core materials
- Heat treated powdered metal for high MRR
- Standard 40° helix

- TiCN coating for extended tool life and improved wear resistance
- DLC coating for improved lubricity and wear resistance
- Ground from specially matched powdered metals
- Precision manufactured in the USA

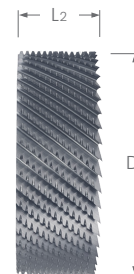
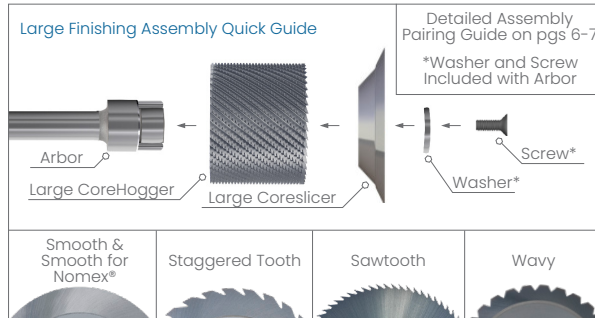

	Diameter D1	Length of Cut L2	Assembly Size Pairing	TiCN Coated		DLC Coated	
				Tool #	Price	Tool #	Price
NEW!	1.4700	.630	45 mm			C65782	310.00
NEW!	1.4700	1.125	45 mm			C69376	335.00
	44 mm	.630	45 mm	C72191	299.00		
	1.9500	.750	2.000	C21117	338.50		
	1.9500	1.500	2.000	C30885	355.00	C78023*	370.00
	61.50 mm	.700	63 mm (A)	C80551	365.00		
	61.50 mm	1.200	63 mm (A)	C62919	439.50		
	2.7500	.950	3.000	C84212	410.00		

* 3° helix

Finishing Core Tools Large Arbors

- Must be paired with Large CoreHogger and Large Coreslicer for use. For proper pairing, reference "Assembly Size Pairing" below
- Heat treated and finish ground for extremely tight tolerances in runout, concentricity, and perpendicularity
- Tightly tolerated for minimized harmonics, longer tool life, and better part finish
- Locking keys are integral to arbor for easy assembly
- High speed steel
- Precision manufactured in the USA

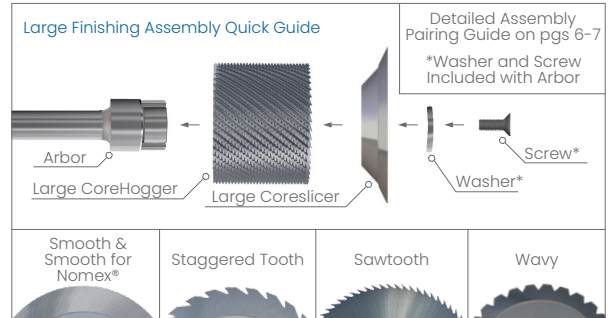

Shank Diameter D ₂	Overall Length L ₁	Assembly Size Pairing	Uncoated	
			Tool #	Price
12 mm	90 mm	2.000 / 63 mm (A) / 3.000	C84383	128.40
.5000	3.500	1.500 / 45 mm	C79286	128.40
.5000	3.500	2.000 / 63 mm (A) / 3.000	C87981	142.30
.6250	3.500	2.000 / 63 mm (A) / 3.000	C46720	147.00
16 mm	90 mm	63 mm (B)	C26433	160.50
.7500	4.250	63 mm (B)	C24685	189.40

Finishing Core Tools - Large

Finishing Core Tools Large Replacement Washers

- Allows CoreHogger to be utilized for roughing applications without the need for a Coreslicer
- Not required for typical assemblies that include Large Coreslicer
- Hardened steel

Assembly Size Pairing	Uncoated	
	Tool #	Price
2.000 / 63 mm (A) / 63 mm (B) / 3.000	C69287	112.00
1.500 / 45 mm	C83666	112.00

Valve Stem Cutters Integral Shank

- Excellent for finish bevel or knife edge parts
- Often used to separate the knife edge from the surrounding material with parting off motion
- Integral shank design provides more side clearance for machining hard to reach or high depth side cuts
- Tapered neck for added clearance
- TiCN coating for extended tool life and improved wear resistance
- Solid carbide
- Precision manufactured in the USA



Diameter D1	Edge Type	Shank Diameter D2	Overall Length L1	Flutes	TiCN Coated	
					Tool #	Price
.7500	Smooth	.2500	3.000	-	C33276	119.10
.7500	Staggered Tooth	.2500	3.000	36	C67092	138.20
.7500	Sawtooth	.2500	3.000	60	C21155	138.20
1.0000	Smooth	.2500	3.000	-	C15602	121.90
1.0000	Staggered Tooth	.2500	3.000	40	C17155	139.70
1.0000	Sawtooth	.2500	3.000	65	C12535	139.70



Find the Perfect CoreHog Tool For Your Next Job With Product Table Filtering

corehog.com

Valve Stem Cutters Slicers

- Must be paired with Valve Stem Arbor for use. For proper pairing, reference "Assembly Size Pairing" below
- Excellent for finish bevel or knife edge parts
- Often used to separate the knife edge from the surrounding material with parting off motion

- DLC coating for improved lubricity and wear resistance
- Solid carbide
- Precision manufactured in the USA

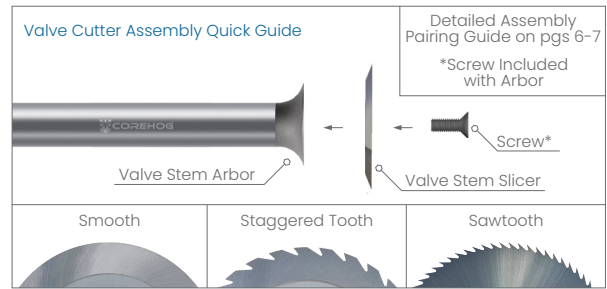

Diameter D1	Edge Type	Flutes	Assembly Size Pairing	DLC Coated	
				Tool #	Price
1.0000	Smooth	-	1.000	C12789	101.20
1.0000	Staggered Tooth	40	1.000	C11921	115.60
1.0000	Sawtooth	65	1.000	C53187	115.60
1.5000	Smooth	-	1.500	C34019	135.40
1.5000	Staggered Tooth	40	1.500	C22937	150.30
1.5000	Sawtooth	75	1.500	C85199	150.30
2.0000	Smooth	-	2.000	C87352	174.90
2.0000	Staggered Tooth	40	2.000	C62872	190.60
2.0000	Sawtooth	90	2.000	C41900	190.60
75 mm	Smooth	-	75 mm	C60434	223.80
75 mm	Staggered Tooth	60	75 mm	C39158	241.20
75 mm	Sawtooth	60	75 mm	C42038	241.20
3.0000	Smooth	-	75 mm	C26818	223.80
3.0000	Staggered Tooth	60	75 mm	C50484	241.20
3.0000	Sawtooth	110	75 mm	C23286	241.20

Valve Stem Cutters Arbors

- Must be paired with Valve Stem Slicer for use. For proper pairing, reference "Assembly Size Pairing" below
- Stem design optimized for free flowing applications, eliminating grabbing when machining honeycomb core materials

- High speed steel
- Precision manufactured in the USA

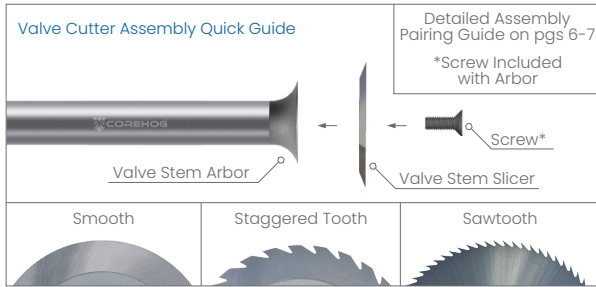

Shank Diameter D ₂	Overall Length L ₁	Assembly Size Pairing	Uncoated	
			Tool #	Price
.5000	3.500	1.000	C67352	146.00
.5000	3.500	1.500	C20736	156.50
.5000	3.500	75 mm	C99465	167.00
.5000	3.500	2.000 / 75 mm	C14216	167.00
12 mm	89 mm	2.000 / 75 mm	C24452	167.00

Valve Stem Cutters

Single Bevel Core Saws

- Engineered for obtaining superior finishes on exterior walls while reducing the need of risers on fixtures
- Unique design allows the spindle to be utilized at a 90° angle to finish trim part profiles
- TiN coating for excellent hardness and improved lubricity
- Pairs well with any standard arbor
- High speed steel
- Precision manufactured in Germany

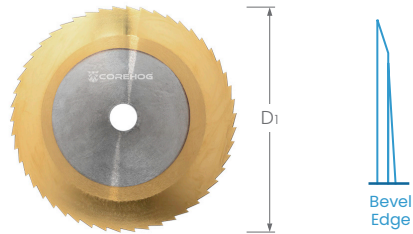

Diameter D ₁	Thickness	Arbor Hole	Flutes	TiN Coated	
				Tool #	Price
250 mm	3 mm	.625	50	C68081	559.50
300 mm	3 mm	30 mm	60	C76240	599.50

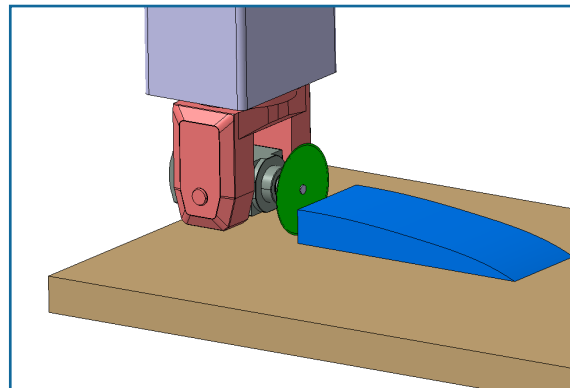

Used at 90° angle for superior finishes on exterior walls

NEW ITEMS

**Wall Finishing Tools
Hollow Cutters - Head**

- Must be paired with Hollow Cutter Arbor for use. For proper pairing, reference "Assembly Size Pairing" below
- Designed to leave pristine finish on vertical and closed pocket walls
- Through hole geometry for enhanced air purge and chip evacuation
- Optimized for use in honeycomb core materials
- Solid carbide
- Precision manufactured in the USA

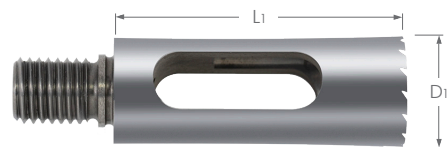
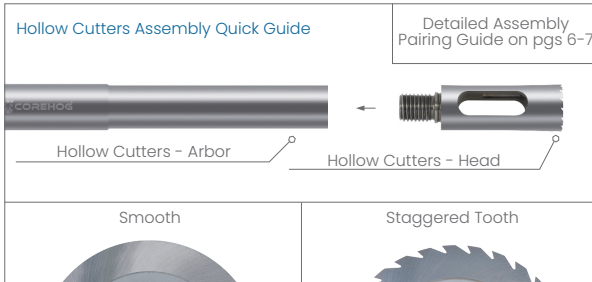

	Diameter D1	Edge Type	Overall Length L1	Assembly Size Pairing	Uncoated	
					Tool #	Price
NEW!	.3750	Smooth	1.300	.375	C23309	325.50
NEW!	.3750	Staggered Tooth	1.300	.375	C77883	325.50
	.5000	Smooth	1.300	.500	C78051	433.00
	.5000	Staggered Tooth	1.300	.500	C24773	433.00
	.7500	Smooth	1.300	.750	C64381	510.50
	.7500	Staggered Tooth	1.300	.750	C16457	510.50

Check Stock of up to 50 Tools at Once
to Simplify the Order Planning Process

corehog.com

Wall Finishing Tools

Wall Finishing Tools Hollow Cutters - Arbor

NEW ITEMS

- Must be paired with Hollow Cutter - Head for use. For proper pairing, reference "Assembly Size Pairing" below
- Designed to leave pristine finish on vertical and closed pocket walls
- Through hole geometry for enhanced air purge and chip evacuation
- Optimized for use in honeycomb core materials
- High speed steel
- Precision manufactured in the USA

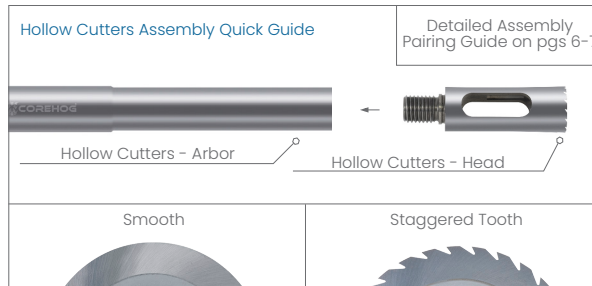
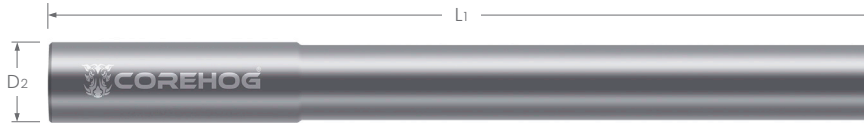

Shank Diameter D ₂	Overall Length L ₁	Assembly Size Pairing	Uncoated		
			Tool #	Price	
.3750	2.700	.375	C85636	279.50	NEW!
.3750	5.700	.375	C96446	319.50	NEW!
.5000	2.700	.500	C92355	295.50	NEW!
.5000	5.700	.500	C75687	349.50	
.7500	2.700	.750	C04236	310.50	NEW!
.7500	5.700	.750	C45203	375.50	

Wall Finishing Tools CoreHoggers - Left Hand

- Engineered to provide smooth vertical walls in aramid honeycomb materials
- Ideal for maintaining cut direction for reverse parts to prevent ribbon tearing
- Designed to produce flag-free finishes with 3-axis machines
- Minimal equipment or complex tool path motions required
- Center cutting
- ZrN coating offers higher hardness and added lubricity for maximum performance
- Solid carbide
- Precision manufactured in the USA

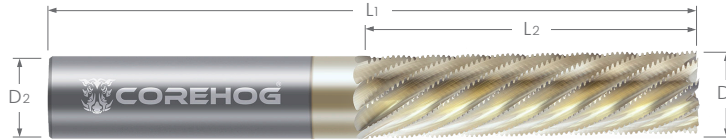

Diameter D1	Length of Cut L2	Shank Diameter D2	Overall Length L1	Flutes	ZrN Coated	
					Tool #	Price
.2500	1.250	.2500	2.500	6	C23956	93.00
.2500	1.250	.2500	4.000	6	C31748	123.50
.2500	2.750	.2500	6.000	6	C28371	143.80
.3750	2.000	.3750	4.000	6	C46610	151.00
.5000	2.000	.5000	4.000	10	C16350	173.60
.5000	3.000	.5000	6.000	10	C31093	228.00
.7500	2.000	.7500	4.000	10	C94437	247.50
.7500	3.000	.7500	6.000	10	C33517	266.00
1.0000	2.000	1.0000	4.000	10	C42937	320.00
1.0000	3.000	1.0000	6.000	10	C25658	362.50

Sandwich Panel Cutters

- Designed for machining sandwich panels in one pass
- Engineered to eliminate manual clean up of parts after machining, while increasing cutting rates by up to 300% over conventional cutters
- Provides excellent performance in CFRP, Nomex®, and Kevlar® bonded panels
- Optimized for outside trimming and slotting applications, or milling fastener cutouts
- Can be used in flat bottom areas when needed for bonding in fasteners
- Geometry allows for free cutting while maintaining excellent tool life and finishes with minimal flagging and fuzz
- Center cutting
- DLC coating for improved lubricity and wear resistance
- Solid carbide
- Precision manufactured in the USA



Diameter D1	Length of Cut L2	Cut Direction	Shank Diameter D2	Overall Length L1	Flutes	DLC Coated	
						Tool #	Price
.2500	.625	Upcut	.2500	2.500	8	C53435	61.50
.2500	1.100	Downcut	.2500	2.500	8	C15485	75.00
.2500	1.250	Upcut	.2500	2.500	8	C36623	75.00
.3750	.875	Upcut	.3750	2.500	12	C22069	89.50
.3750	1.250	Upcut	.3750	2.500	12	C34819	99.50
.5000	1.375	Upcut	.5000	3.000	10	C76408	118.50

Sandwich Panel Cutters – Compression Cutters

- Engineered to eliminate manual clean up of parts after machining, while increasing cutting rates by up to 300% over conventional cutters
- Excellent choice for eliminating Tedlar® fray on sandwich panels skinned with Tedlar®
- Provides excellent performance in CFRP, Nomex®, and Kevlar® bonded panels
- Optimized for outside trimming and slotting applications, or milling fastener cutouts
- Can be used in flat bottom areas when needed for bonding in fasteners
- Geometry allows for free cutting while maintaining excellent tool life and finishes with minimal flagging and fuzz
- Center cutting
- DLC coating for improved lubricity and wear resistance
- Solid carbide
- Precision manufactured in the USA

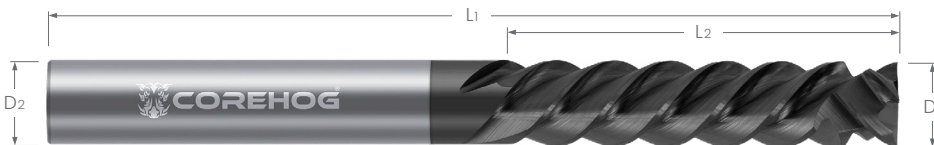

Diameter D1	Length of Cut L2	Shank Diameter D2	Overall Length L1	Flutes	DLC Coated	
					Tool #	Price
.2500	1.125	.2500	3.000	4	C43415	70.70

Rebating Cutters Integrated Shank

- Optimized for removing material between face sheets on honeycomb core sandwich panel
- Designed for increased productivity and increased MRR when cutting honeycomb core materials
- Geometry reduces tearing, flagging, and fuzz, while providing a rebated area to allow for edge filling or fasteners
- Excellent for outside edges as well as internal circular or rectangular rebate requirements
- Center cutting
- Solid carbide
- Precision manufactured in the USA



Diameter D1	Length of Cut L2	Shank Diameter D2	Overall Length L1	Flutes	Uncoated	
					Tool #	Price
.5000	.315	.2362	2.500	10	C26494	126.10
.5000	.335	.2362	2.500	10	C27904	126.10
.5000	.600	.2362	2.500	10	C89350	133.20
13 mm	12.7 mm	6 mm	89 mm	10	C54641*	133.20
.7500	.335	.2362	2.500	10	C96274	157.20

* End cutting (not center cutting)

Rebating Cutters

Build & Send Shopping Carts Directly to Your Distributor or Purchasing Agent
corehog.com

Rebating Cutters Core Insert

- Must be paired with Rebating Cutter Arbors for use. For proper pairing, reference “Assembly Size Pairing” below
- Design reduces setups, cost per cutter, and provides flexibility with varying sandwich panel configurations
- Optimized for removing material between face sheets on honeycomb core sandwich panel
- Excellent for outside edges as well as internal circular or rectangular rebate requirements
- Complex geometry reduces tearing, flagging, and fuzz while providing a rebated area to allow for edge filling or fasteners later on
- TiAlN coating for high hardness and high temperature resistance
- Solid carbide
- Precision manufactured in the USA

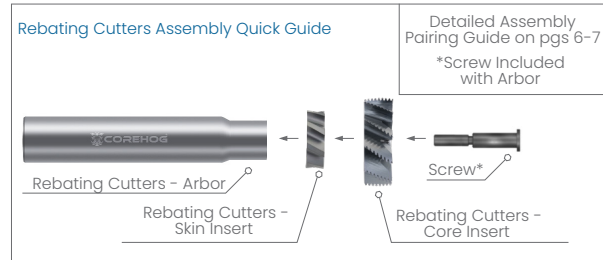
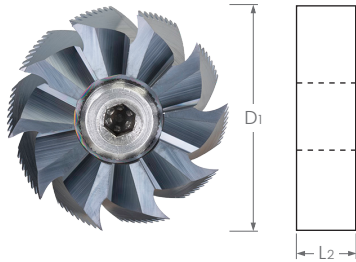

Diameter D1	Length of Cut L2	Flutes	Assembly Size Pairing	TiAlN Coated	
				Tool #	Price
.8750	.160	10	3.000	C18949	110.00
.8750	.210	10	3.000	C15104	110.00
.8750	.250	10	3.000	C62536	110.00
.8750	.380	10	3.000	C18259	110.00
.8750	.450	10	3.000	C27240	110.00
.8750	.475	10	3.000	C91505	110.00
.8750	.500	10	3.000	C74679	110.00
1.0000	.312	10	3.000	C95727	142.50

NEW ITEMS

**Rebating Cutters
Skin Insert**

- Must be paired with Rebating Cutter Arbors for use and is recommended to use Rebating Cutter Core Inserts. For proper pairing, reference “Assembly Size Pairing” below
- Engineered for top trimming while rebating
- Design reduces setups, cost per cutter, and provides flexibility with varying sandwich panel configurations
- Rigid build for machining in abrasive materials such as CFRP and fiberglass
- DLC coating for improved lubricity and wear resistance

- True crystalline CVD diamond coating for drastically improved hardness for outstanding abrasion resistance and higher feed rates
- PCD diamond brazed onto solid carbide body for outstanding microhardness and abrasion resistance for significant improvement in tool life
- Solid carbide
- Precision manufactured in the USA

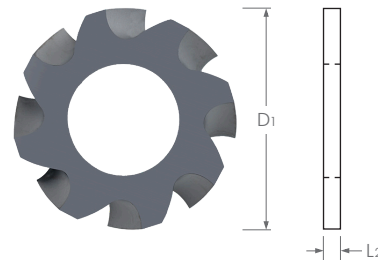
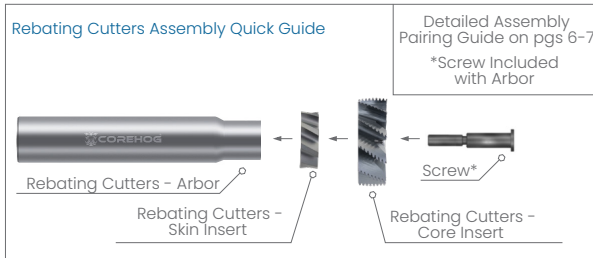

Rebating Cutters

NEW!

Diameter D1	Length of Cut L2	Assembly Size Pairing	DLC Coated		CVD Coated		PCD Diamond	
			Tool #	Price	Tool #	Price	Tool #	Price
.5000	.150	3.000	C32952	72.50	C22196	118.10	C66357	237.50

**Rebating Cutters
Arbor**

- Must be paired with Rebating Cutter Core Inserts for use. For proper pairing, reference “Assembly Size Pairing” below
- Design reduces setups, cost per cutter, and provides flexibility with varying sandwich panel configurations

- Complex geometry reduces tearing, flagging, and fuzz while providing a rebated area to allow for edge filling or fasteners later on
- High speed steel
- Precision manufactured in the USA

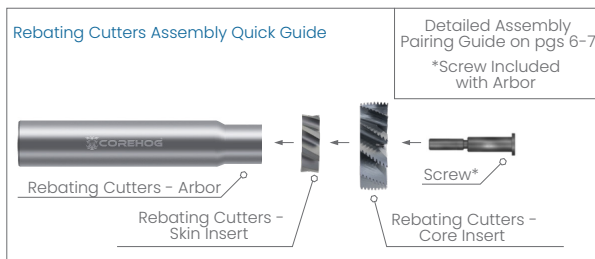

Shank Diameter D2	Overall Length L1	Assembly Size Pairing	Uncoated	
			Tool #	Price
.500	3.000	3.000	C41516	126.50

NEW

Potted Fastener Cutters

- Designed to cut holes in non-metallic sandwich panels to receive epoxied fasteners
- Special sizing allows for plunging and rebating in a one-shot operation, eliminating the need for additional tooling
- Engineered to finely shred honeycomb, eliminating the need for manual clean up
- Center cutting
- DLC coating for improved lubricity and wear resistance
- Solid carbide
- Precision manufactured in the USA



Diameter	Length of Cut	Shank Diameter	Overall Length	DLC Coated	
				Tool #	Price
D1	L2	D2	L1		
.4531	.454	6 mm	89 mm	C51919	159.50
.5625	.454	6 mm	89 mm	C57814	189.50

NEW!

NEW!

Potted Fastener Cutters

Download Speeds & Feeds Charts For Every CoreHog Cutting Tool

corehog.com

CFRP Routers Rougher/Finisher - Upcut

CFRP Routers

- Unique geometry for increased MRR and reduced cutting forces in roughing applications
- Provides excellent performance when semi-finishing G10 glass, fiberglass, glass, and fiber filled plastic
- Center cutting
- True crystalline CVD diamond coating for drastically improved hardness for outstanding abrasion resistance and higher feed rates
- Solid carbide
- Precision manufactured in the USA

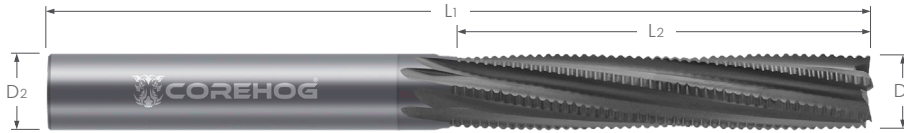

Diameter	Length of Cut	Shank Diameter	Overall Length	Flutes	CVD Coated	
					Tool #	Price
D1 .2500	L2 1.000	D2 .2500	L1 3.000	4	C90209	141.80
.3750	1.250	.3750	3.000	6	C30440	201.80
.3750	2.000	.3750	4.000	6	C45627	221.80
.5000	1.500	.5000	4.000	8	C33933	280.70



CFRP Routers Finisher - Upcut

- Shearing action provides a fuzz-free finish with minimal delamination
- Smooth flute design for excellent finish on walls
- Provides excellent performance when finishing G10 glass, fiberglass, glass, and fiber filled plastic
- Center cutting
- DLC coating for improved lubricity and wear resistance
- True crystalline CVD diamond coating for drastically improved hardness for outstanding abrasion resistance and higher feed rates
- Solid carbide
- Precision manufactured in the USA

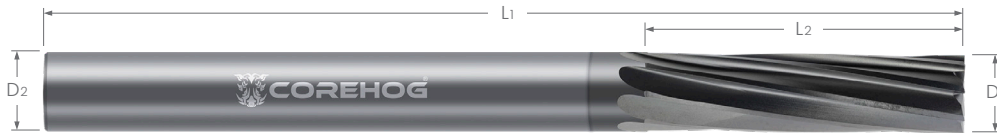

Diameter D1	Length of Cut L2	Shank Diameter D2	Overall Length L1	Flutes	DLC Coated		CVD Coated	
					Tool #	Price	Tool #	Price
.2500	1.000	.2500	2.500	8	C23730	77.00	C73272	131.30
.3750	1.125	.3750	3.000	8	C68988	101.80	C84996	187.30
.5000	1.250	.5000	3.000	8	C70633	144.40	C24389	288.80
.5000	1.500	.5000	4.000	8			C67224	266.70

Find an Authorized CoreHog Distributor in Your State or Province and Start Ordering Today

corehog.com

CFRP Routers Burr End Style - Upcut

CFRP Routers

- Burr style end allows for ramping, not suited for plunge cutting
- Free cutting geometry minimizes delamination and provides excellent part finish
- Optimized for trimming CFRP and provides excellent performance in S-glass and other fiberglass materials
- DLC coating for improved lubricity and wear resistance
- True crystalline CVD diamond coating for drastically improved hardness for outstanding abrasion resistance and higher feed rates
- Solid carbide
- Precision manufactured in the USA



Diameter D1	Length of Cut L2	Shank Diameter D2	Overall Length L1	Flutes	DLC Coated		CVD Coated	
					Tool #	Price	Tool #	Price
.1250	.500	.1250	2.000	8	C29759	52.50	C25760	79.70
.1875	.875	.1875	2.500	8	C47397	60.50	C32315	109.50
.2500	.750	.2500	2.500	10	C17487	65.50	C10057	114.40
.2500	1.000	.2500	3.000	10			C23690	120.70
.3750	1.000	.3750	3.000	12	C22375	102.50	C90400	198.50
.3750	1.000	.3750	4.000	12			C61465	207.10
.5000	1.500	.5000	3.000	14	C85755	123.50	C85758	271.30
.7500	2.000	.7500	4.000	16	C35161	189.00	C69497	494.20



CFRP Routers Burr End Style - Downcut

- Downcut geometry stabilizes part against fixture and reduces vibration by applying downward pressure
- Free cutting geometry minimizes delamination and provides excellent part finish
- Burr style end allows for ramping, not suited for plunge cutting
- Optimized for trimming CFRP and provides excellent performance in S-glass and other fiberglass materials
- DLC coating for improved lubricity and wear resistance
- True crystalline CVD diamond coating for drastically improved hardness for outstanding abrasion resistance and higher feed rates
- Solid carbide
- Precision manufactured in the USA

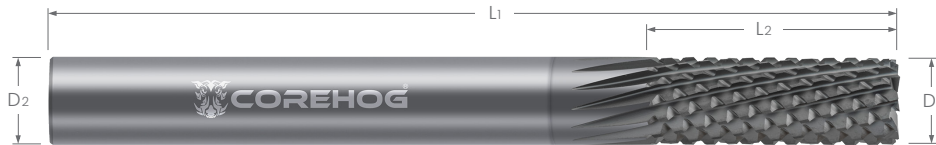

Diameter	Length of Cut	Shank Diameter	Overall Length	Flutes	DLC Coated		CVD Coated	
					Tool #	Price	Tool #	Price
D1	L2	D2	L1					
.2500	.750	.2500	2.500	8	C73670*	67.50	C95468	120.60
.3750	1.000	.3750	3.000	14	C66310	105.50	C87132	202.20
.5000	1.500	.5000	3.000	14	C20235	127.00	C96237	284.70
.7500	2.000	.7500	4.000	16	C69001	195.00	C97846	506.30

* Center cutting

CFRP Routers End Mill Style - Upcut

- Free cutting geometry minimizes delamination and provides excellent part finish
- Optimized for trimming CFRP and provides excellent performance in Fiberglass and S-Glass
- Geometry allows for ramping and plunging
- Center cutting
- DLC coating for improved lubricity and wear resistance
- True crystalline CVD diamond coating for drastically improved hardness for outstanding abrasion resistance and higher feed rates
- Solid carbide
- Precision manufactured in the USA



Diameter	Length of Cut	Shank Diameter	Overall Length	Flutes	DLC Coated		CVD Coated	
					Tool #	Price	Tool #	Price
D1	L2	D2	L1					
.1250	.500	.1250	2.000	8	C62250	52.50	C28064	79.70
.1875	.875	.1875	2.500	8	C91130	60.50	C28469	109.50
.2500	.750	.2500	2.500	10	C75739	65.50	C30903	114.40
.3750	1.000	.3750	3.000	12	C18480	102.50	C61622	198.50
.3750	1.000	.3750	4.000	12			C75207	207.10
.5000	1.500	.5000	3.000	14	C26546	123.50	C58718	271.30



CFRP Routers

Drill Point Style - Upcut

- Free cutting geometry minimizes delamination and provides excellent part finish
- Optimized for trimming CFRP and provides excellent performance in S-glass and other fiberglass materials
- Geometry allows for plunging or drilling entry
- Center cutting
- DLC coating for improved lubricity and wear resistance
- True crystalline CVD diamond coating for drastically improved hardness for outstanding abrasion resistance and higher feed rates
- Solid carbide
- Precision manufactured in the USA



Diameter D1	Length of Cut L2	Shank Diameter D2	Overall Length L1	Flutes	DLC Coated		CVD Coated	
					Tool #	Price	Tool #	Price
.1250	.500	.1250	2.000	8	C97821	57.50	C41492	86.00
.1875	.875	.1875	2.500	8	C61895	68.60	C68364	111.20
.2500	.750	.2500	2.500	10	C52495	71.00	C61695	120.60
.3750	1.000	.3750	3.000	12	C23154	110.80	C35013	202.40
.3750	1.000	.3750	4.000	12			C69764	212.00
.5000	1.500	.5000	3.000	14	C90390	134.30	C87478	284.70

NEW

CFRP Routers Compression Style

CFRP Routers

- Engineered for high performance in CFRP, GFRP and other fiber reinforced materials
- Compression geometry minimizes delamination and frayed fibers
- Center cutting
- True crystalline CVD diamond coating for drastically improved hardness for outstanding abrasion resistance and higher feed rates
- Solid carbide
- Precision manufactured in the USA

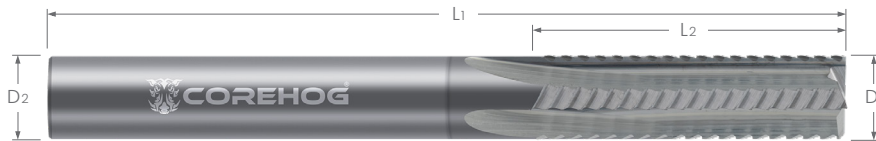

	Diameter	Length of Cut	Shank Diameter	Overall Length	Flutes	CVD Coated	
	D1	L2	D2	L1		Tool #	Price
NEW!	.2500	.750	.2500	3.000	4	C49274	139.50
NEW!	.3750	.750	.3750	3.000	6	C56223	199.50
NEW!	.5000	.750	.5000	3.000	8	C60915	269.50

Find the Perfect CoreHog Tool For Your Next Job With Product Table Filtering

corehog.com

CFRP MAX Routers

Burr End Style - Upcut

- Designed to provide high feed rates while maintaining excellent finish
- Free cutting geometry minimizes delamination
- Optimized for trimming CFRP and provides excellent performance in S-glass and other fiberglass materials
- Burr style end allows for ramping, not suited for plunge cutting
- True crystalline CVD diamond coating for drastically improved hardness for outstanding abrasion resistance and higher feed rates
- Solid carbide
- Precision manufactured in the USA



Diameter D ₁	Length of Cut L ₂	Shank Diameter D ₂	Overall Length L ₁	Flutes	CVD Coated	
					Tool #	Price
.1875	.875	.1875	2.500	6	C16639	101.10
.2500	.750	.2500	3.000	8	C59526	119.50
.2500	1.000	.2500	3.000	8	C36367	125.50
.3750	1.250	.3750	3.000	10	C86072	199.60
.5000	1.500	.5000	3.000	12	C60516	271.30
.5000	1.500	.5000	4.000	12	C81281	280.70

CFRP MAX Routers End Mill Style - Upcut

- Designed to provide high feed rates while maintaining excellent finish
- Free cutting geometry minimizes delamination
- Optimized for trimming CFRP and provides excellent performance in S-glass and other fiberglass materials
- Geometry allows for ramping and plunging
- Center cutting
- True crystalline CVD diamond coating for drastically improved hardness for outstanding abrasion resistance and higher feed rates
- Solid carbide
- Precision manufactured in the USA

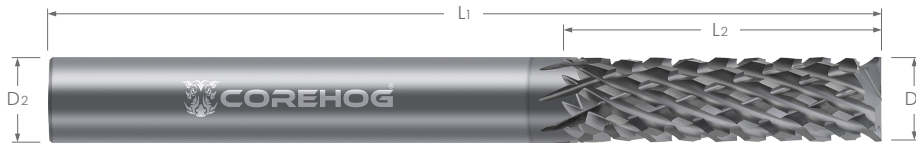

Diameter D1	Length of Cut L2	Shank Diameter D2	Overall Length L1	Flutes	CVD Coated	
					Tool #	Price
.1875	.875	.1875	2.500	6	C69823	101.10
.2500	.750	.2500	3.000	8	C91247	119.50
.2500	1.000	.2500	3.000	8	C49457	125.50
.3750	1.250	.3750	3.000	10	C14978	199.60
.5000	1.500	.5000	3.000	12	C37776	271.30
.5000	1.500	.5000	4.000	12	C39307	280.70

CFRP MAX Routers

CFRP MAX Routers

Drill Point Style - Upcut

- Geometry allows for plunging or drilling entry
- Designed to provide high feed rates while maintaining excellent finish
- Free cutting geometry minimizes delamination
- Optimized for trimming CFRP and provides excellent performance in S-glass and other fiberglass materials
- Center cutting
- True crystalline CVD diamond coating for drastically improved hardness for outstanding abrasion resistance and higher feed rates
- Solid carbide
- Precision manufactured in the USA

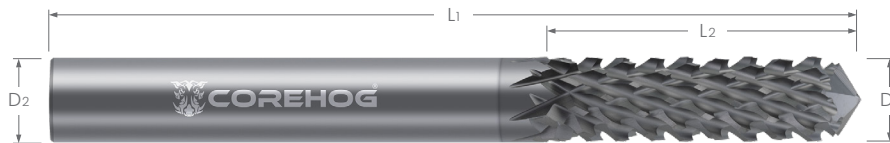

Diameter D1	Length of Cut L2	Shank Diameter D2	Overall Length L1	Flutes	CVD Coated	
					Tool #	Price
.1875	.875	.1875	2.500	6	C11591	104.90
.2500	.750	.2500	3.000	8	C76993	124.40
.2500	1.000	.2500	3.000	8	C60093	129.50
.3750	1.250	.3750	3.000	10	C18724	203.40
.5000	1.500	.5000	3.000	12	C18336	275.10
.5000	1.500	.5000	4.000	12	C83530	284.40

Check Stock of up to 50 Tools at Once
to Simplify the Order Planning Process

corehog.com

NEW

Laminate Kevlar Cutters Compression Style

- Engineered for high performance in laminated Kevlar®
- Compression geometry and high edge sharpness ensure cleanly cut Kevlar® with minimized fraying
- Cuts low resin/high fiber Kevlar® cleanly, reducing the need for manual rework of frayed parts
- Center cutting
- Solid carbide
- Precision manufactured in the USA

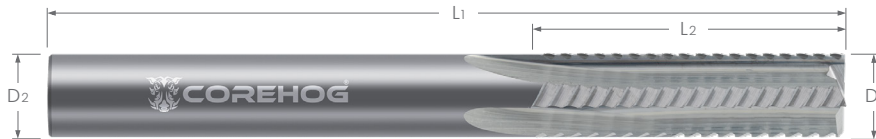

	Diameter D1	Length of Cut L2	Shank Diameter D2	Overall Length L1	Flutes	Uncoated	
						Tool #	Price
NEW!	.2500	.750	.2500	3.000	4	C88089	39.50
NEW!	.3750	.750	.3750	3.000	6	C68061	46.50
NEW!	.5000	.750	.5000	3.000	8	C49244	56.50

Laminate Kevlar Cutters

PCD Diamond End Mills

Square

- Free cutting geometry minimizes delamination and provides excellent part finish
- Provides excellent performance in tough materials like G10 glass and carbon fiber
- PCD diamond brazed onto solid carbide body for outstanding microhardness and abrasion resistance for significant improvement in tool life
- Center cutting
- Precision manufactured in Italy



Diameter D1	Length of Cut L2	Shank Diameter D2	Overall Length L1	Flutes	PCD Diamond	
					Tool #	Price
.1250	.250	.1250	1.500	1	C74984	182.50
.1875	.250	.1875	2.000	2	C79979	212.40
.2500	.250	.2500	2.500	2	C79748	216.10
.3750	.312	.3750	2.500	2	C82527	294.00
.5000	.312	.5000	3.000	2	C12470	393.80
.7500	.500	.7500	4.000	2	C31980	532.10
1.0000	.750	1.0000	4.000	2	C99963	771.00

PCD Diamond End Mills

Ball

- Free cutting geometry minimizes delamination and provides excellent part finish
- Optimized for shaping hard and abrasive materials such as fiberglass, carbon fiber, and phenolic
- Provides excellent performance in finishing applications of complex surfaces and shapes in difficult to machine materials
- Center cutting
- PCD diamond brazed onto solid carbide body for outstanding microhardness and abrasion resistance for significant improvement in tool life
- Precision manufactured in Italy



Diameter D1	Length of Cut L2	Shank Diameter D2	Overall Length L1	Flutes	PCD Diamond	
					Tool #	Price
.1250	.250	.1250	1.500	1	C66271	188.20
.1875	.312	.1875	2.000	2	C64310	224.90
.2500	.312	.2500	2.500	2	C27976	220.90
.3750	.437	.3750	2.500	2	C30325	301.90
.5000	.500	.5000	3.000	2	C90424	398.80
.7500	.500	.7500	4.000	2	C94917	547.40
1.0000	.750	1.0000	4.000	2	C98151	785.00

PCD Diamond End Mills

Miniature Diamond Coated End Mills Square

NEW

- Provides excellent performance in miniature milling applications for a wide range of composites
- Center cutting
- DLC coating for improved lubricity and wear resistance
- True crystalline CVD diamond coating for drastically improved hardness for outstanding abrasion resistance and higher feed rates
- Solid carbide
- Precision manufactured in the USA



Diameter D ₁	Length of Cut L ₂	Shank Diameter D ₂	Overall Length L ₁	Flutes	DLC Coated		CVD Coated		
					Tool #	Price	Tool #	Price	
.0150	.045	.1250	1.500	4	C63366	34.30			NEW!
.0200	.060	.1250	1.500	4	C52247	33.50			NEW!
.0310	.093	.1250	1.500	4	C26094	31.80	C97916	45.50	NEW!
.0470	.141	.1250	1.500	4	C06242	29.40	C49003	43.10	NEW!
.0620	.186	.1250	1.500	4	C22672	27.70	C35367	41.40	NEW!
.0620	.312	.1250	2.500	4	C89613	32.00	C69738	45.70	NEW!
.0780	.234	.1250	1.500	4	C00480	27.70	C39774	41.40	NEW!
.0780	.406	.1250	2.500	4	C26466	32.00	C76058	45.70	NEW!
.0930	.279	.1250	1.500	4	C83205	27.70	C39936	41.40	NEW!
.0930	.500	.1250	2.500	4	C95783	32.00	C46161	45.70	NEW!
.1250	.375	.1250	1.500	4	C28088	27.30	C83369	41.00	NEW!
.1250	.625	.1250	2.500	4	C92546	31.60	C18812	45.30	NEW!
.1875	.570	.1875	2.000	4	C46488	33.40	C30238	65.80	NEW!
.1875	1.000	.1875	3.000	4	C22427	37.20	C21588	69.60	NEW!
.2500	.750	.2500	2.500	4	C16766	37.30	C83477	74.50	NEW!
.2500	1.250	.2500	4.000	4	C24339	42.00	C76242	79.20	NEW!

NEW

Miniature Diamond Coated End Mills **Ball**

Miniature Diamond Coated End Mills

- Provides excellent performance in miniature milling applications for a wide range of composites
- Center cutting
- DLC coating for improved lubricity and wear resistance
- True crystalline CVD diamond coating for drastically improved hardness for outstanding abrasion resistance and higher feed rates
- Solid carbide
- Precision manufactured in the USA



	Diameter D1	Length of Cut L2	Shank Diameter D2	Overall Length L1	Flutes	DLC Coated		CVD Coated	
						Tool #	Price	Tool #	Price
NEW!	.0620	.186	.1250	1.500	4	C74026	34.80	C57148	48.50
NEW!	.0780	.234	.1250	1.500	4	C89179	34.80	C50223	48.50
NEW!	.0930	.279	.1250	1.500	4	C16327	34.80	C00358	48.50
NEW!	.1250	.375	.1250	1.500	4	C38062	33.50	C69322	47.20
NEW!	.1875	.570	.1875	2.000	4	C53612	39.60	C19979	72.00
NEW!	.2500	.750	.2500	2.500	4	C26137	44.30	C92633	81.50

Build & Send Shopping Carts Directly to Your Distributor or Purchasing Agent

corehog.com

Diamond Cut Routers Burr End Style

- Specially designed for routing fiber reinforced, epoxy resin, and composites
- Engineered with diamond cut flute pattern to reduce delamination and provide smooth cutting action
- Standard cut profile
- DLC coating for improved lubricity and wear resistance
- Solid carbide
- Precision manufactured in the USA

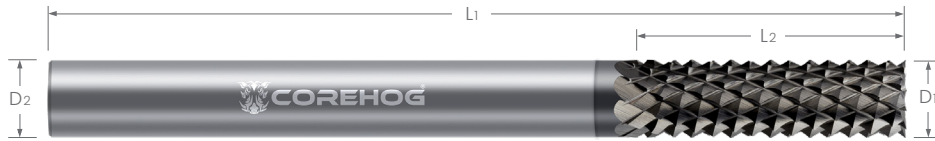

Diameter D1	Length of Cut L2	Shank Diameter D2	Overall Length L1	Flutes	Uncoated		DLC Coated	
					Tool #	Price	Tool #	Price
.2500	1.250	.2500	3.000	7	C70016	38.80	C36346	43.60
.2500	1.750	.2500	4.000	7	C28344	45.50	C88891	50.20
.3125	.750	.3125	2.500	9	C84729	41.00	C21464	45.80
.3750	1.250	.3750	3.000	10	C67528	46.00	C54430	50.60
.5000	1.250	.5000	3.000	17	C57182	56.30	C63031	60.60

Diamond Cut Routers

Download Speeds & Feeds Charts For Every CoreHog Cutting Tool

corehog.com

Diamond Cut Routers End Mill Style

- Specially designed for routing fiber reinforced, epoxy resin, and composites
- Engineered with diamond cut flute pattern to reduce delamination and provide smooth cutting action
- Center cutting
- DLC coating for improved lubricity and wear resistance
- Solid carbide
- Precision manufactured in the USA



Diameter D1	Length of Cut L2	Shank Diameter D2	Overall Length L1	Flutes	Uncoated		DLC Coated	
					Tool #	Price	Tool #	Price
.2500	1.250	.2500	3.000	7	C87510	38.80	C19396	43.60
.2500	1.750	.2500	4.000	7	C72576	45.50	C75176	50.20
.3125	.750	.3125	2.500	9	C50116	41.00	C11470	45.80
.3750	1.250	.3750	3.000	10	C90419	46.00	C89565	50.60
.5000	1.250	.5000	3.000	17	C48175	56.30	C71414	60.60

Diamond Cut Routers



Diamond Cut Routers

Drill Point Style

- Specially designed for routing fiber reinforced, epoxy resin, and composites
- Engineered with diamond cut flute pattern to reduce delamination and provide smooth cutting action
- 135° drill point
- Center cutting
- DLC coating for improved lubricity and wear resistance
- Solid carbide
- Precision manufactured in the USA



Diameter D ₁	Length of Cut L ₂	Shank Diameter D ₂	Overall Length L ₁	Flutes	Uncoated		DLC Coated	
					Tool #	Price	Tool #	Price
.2500	1.250	.2500	3.000	7	C17331	40.40	C39339	45.00
.2500	1.750	.2500	4.000	7	C80150	47.30	C72397	54.80
.3125	.750	.3125	2.500	9	C85678	42.60	C63083	48.10
.3750	1.250	.3750	3.000	10	C36362	47.80	C30807	53.30
.5000	1.250	.5000	3.000	17	C74177	58.50	C69523	65.70

Plastic Cutters – Single Flute Square – Upcut

- Designed for maximum stock removal while maintaining excellent finish
- Engineered with high rake and high relief for improved shearing action while transferring heat into the chip
- Large flute valley for maximum chip evacuation
- Polished flute face
- Right hand spiral, right hand cut
- Solid carbide
- Precision manufactured in the USA



Diameter D1	Length of Cut L2	Shank Diameter D2	Overall Length L1	Uncoated	
				Tool #	Price
.1250	.500	.2500	2.000	C36039*	30.30
.1875	.625	.2500	2.000	C91695*	30.30
.2500	.750	.2500	2.500	C35749	30.30
.3750	1.125	.3750	2.500	C66407	61.60
.5000	1.500	.5000	3.000	C16321	104.90

* Tools are ground on oversized, router-style shank

Plastic Cutters – Single Flute Square – Downcut

- Designed to prevent fraying and chipout of top edge of work piece
- Engineered with high rake and high relief for improved shearing action while transferring heat into the chip
- Designed to resist chip welding
- Polished flute face
- Left hand spiral, right hand cut
- Solid carbide
- Precision manufactured in the USA



Diameter D1	Length of Cut L2	Shank Diameter D2	Overall Length L1	Uncoated	
				Tool #	Price
.1250	.500	.2500	2.000	C96764*	33.20
.1875	.625	.2500	2.000	C23057*	33.20
.2500	.750	.2500	2.500	C33929	33.20

* Tools are ground on oversized, router-style shank

Plastic Cutters - 2 Flute Square - Upcut

- Engineered with high rake, high relief, and large flute valley for maximum chip removal
- 2 flute design for improved rigidity, less deflection, and maximum tool life
- Center cutting
- Polished flute face
- Solid carbide
- Precision manufactured in the USA

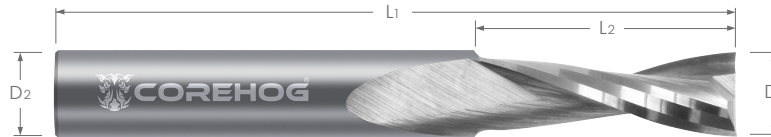

Diameter D1	Length of Cut L2	Shank Diameter D2	Overall Length L1	Uncoated	
				Tool #	Price
.0625	.187	.1250	1.500	C34914	25.10
.0937	.281	.1250	1.500	C81709	25.10
.1250	.375	.1250	1.500	C82174	25.10
.1875	.562	.1875	2.000	C60498	33.10
.2500	.750	.2500	2.500	C76571	40.80
.3750	1.125	.3750	3.000	C20380	70.00
.5000	1.500	.5000	4.000	C34254	123.20

Plastic Cutters - 2 Flute Square - Downcut

- Designed to prevent fraying and chipout of top edge of work piece
- Engineered with high rake, high relief, and large flute valley for maximum chip removal
- 2 flute design for improved rigidity, less deflection, and maximum tool life
- Polished flute face
- Left hand spiral, right hand cut
- Solid carbide
- Precision manufactured in the USA

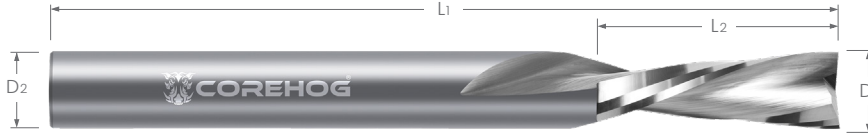

Diameter D1	Length of Cut L2	Shank Diameter D2	Overall Length L1	Uncoated	
				Tool #	Price
.0625	.187	.1250	1.500	C68945	29.60
.0937	.281	.1250	1.500	C12339	29.60
.1250	.375	.1250	1.500	C20225	29.60
.1875	.562	.1875	2.000	C52478	40.20
.2500	.750	.2500	2.500	C71092	47.70
.3750	1.125	.3750	3.000	C90317	81.00
.5000	1.500	.5000	4.000	C31660	146.00

Plastic Cutters - 2 Flute

Plastic Cutters – 2 Flute Ball – Upcut

- Ball end design engineered for profiling complex shapes
- Engineered with increased rake and relief for improved cutting action at tip of ball
- Polished flute face
- Solid carbide
- Precision manufactured in the USA

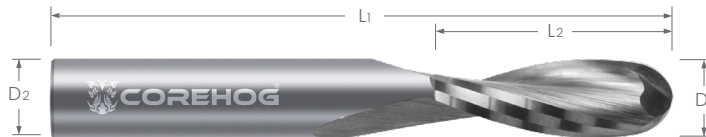

Diameter D1	Length of Cut L2	Shank Diameter D2	Overall Length L1	Uncoated	
				Tool #	Price
.0625	.187	.1250	1.500	C75231	29.10
.0937	.281	.1250	1.500	C25103	29.10
.1250	.375	.1250	1.500	C13644	29.10
.1875	.562	.1875	2.000	C82706	38.40
.2500	.750	.2500	2.500	C19663	49.10
.3750	1.125	.3750	3.000	C58070	78.60
.5000	1.500	.5000	4.000	C50149	135.50

Plastic Cutters – 2 Flute



Find an Authorized CoreHog Distributor
in Your State or Province and Start
Ordering Today

corehog.com

NEW

Miniature Drills

Miniature Drills

- Provides excellent performance in miniature drilling applications for a wide range of composite and plastic materials
- 130° drill point
- DLC coating for improved lubricity and wear resistance
- Solid carbide
- CNC ground in Germany



	Size	Diameter D1	Length of Flute L2	Shank Diameter D2	Overall Length L1	Uncoated		DLC Coated	
						Tool #	Price	Tool #	Price
NEW!	#76	.0200	.2750	.1250	1.500	C85817*	14.80	C41681*	26.50
NEW!	#74	.0225	.2750	.1250	1.500	C87905	14.80	C58478	26.50
NEW!	#72	.0250	.2750	.1250	1.500	C72330	14.80	C56309	26.50
NEW!	#70	.0280	.3350	.1250	1.500	C20630	14.80	C96445	26.50
NEW!	1/32	.0312	.3950	.1250	1.500	C05422	13.90	C06401	25.60
NEW!	#65	.0350	.3950	.1250	1.500	C22566	13.90	C33157	25.60
NEW!	#60	.0400	.3950	.1250	1.500	C32841	13.90	C22144	25.60
NEW!	3/64	.0469	.3950	.1250	1.500	C41888	13.90	C01618	25.60
NEW!	#55	.0520	.4130	.1250	1.500	C97738	13.90	C88321	25.60
NEW!	#54	.0550	.4130	.1250	1.500	C02137	13.90	C67626	25.60
NEW!	1.5 mm	.0591	.4130	.1250	1.500	C86584	13.90	C14457	25.60
NEW!	1/16	.0625	.4130	.1250	1.500	C53314	13.90	C93976	25.60
NEW!	#50	.0700	.4130	.1250	1.500	C46190	13.90	C05271	25.60
NEW!	5/64	.0781	.4130	.1250	1.500	C45404	13.90	C44365	25.60
NEW!	2 mm	.0787	.4130	.1250	1.500	C11251	13.90	C32612	25.60
NEW!	#46	.0810	.4130	.1250	1.500	C54166	13.90	C06878	25.60
NEW!	#43	.0890	.4130	.1250	1.500	C98529	13.90	C32257	25.60
NEW!	#40	.0980	.4130	.1250	1.500	C48269	13.90	C63568	25.60
NEW!	7/64	.1094	.4130	.1250	1.500	C89212	13.90	C73420	25.60
NEW!	3 mm	.1181	.4130	.1250	1.500	C08339	13.90	C87494	25.60
NEW!	1/8	.1250	.4130	.1250	1.500	C76772	13.90	C60368	25.60

* Tool has an intermediate neck diameter of .028 and a total overhang from shank of .413





CFRP Drills

- Provides superior results in CFRP while delivering excellent performance in other laminate and stack composite materials
- Specially engineered geometry allows for outstanding tool life, finish, and repeatability while eliminating edge swelling, tear out, and delamination
- Designed with high strength and rigidity while maintaining tight tolerance
- For use in both hand and CNC drilling operations
- True crystalline CVD diamond coating for drastically improved hardness for outstanding abrasion resistance and higher feed rates
- Solid carbide
- Precision manufactured in the USA

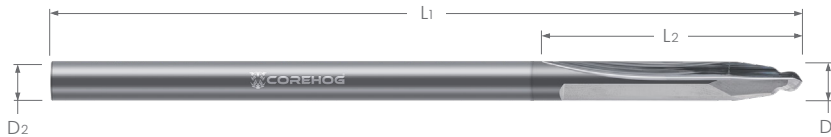

CFRP Drills

Size	Diameter D1	Length of Flute L2	Shank Diameter D2	Overall Length L1	Uncoated		CVD Coated		
					Tool #	Price	Tool #	Price	
#40	.0980	1.000	.0980	4.000	C11245	45.30	C67898	70.70	NEW!
#40	.0980	1.000	.0980	6.000	C46975	54.50	C41878	82.90	NEW!
1/8	.1250	1.000	.1250	4.000	C01180	45.30	C58231	70.70	NEW!
1/8	.1250	1.000	.1250	6.000	C52197	54.50	C68811	82.90	NEW!
#30	.1285	1.000	.1285	4.000	C60769	43.10	C39368	91.60	NEW!
#30	.1285	1.000	.1285	6.000	C33597	51.00	C81180	102.50	NEW!
9/64	.1406	1.000	.1406	4.000	C97193	47.20	C53764	95.70	NEW!
9/64	.1406	1.000	.1406	6.000	C26100	55.70	C27434	107.20	NEW!
5/32	.1563	1.000	.1563	4.000	C37194	47.20	C19315	95.70	NEW!
5/32	.1563	1.000	.1563	6.000	C20504	55.70	C18327	107.20	NEW!
#21	.1590	1.000	.1590	4.000	C75450	47.20	C13983	95.70	NEW!
#21	.1590	1.000	.1590	6.000	C86783	55.70	C23806	107.20	NEW!
#20	.1610	1.000	.1610	4.000	C95531	47.20	C98977	95.70	NEW!
#20	.1610	1.000	.1610	6.000	C78335	55.70	C16047	107.20	NEW!
11/64	.1719	1.000	.1719	4.000	C51345	47.20	C64410	95.70	NEW!
11/64	.1719	1.000	.1719	6.000	C58220	55.70	C28143	107.20	NEW!
3/16	.1875	1.000	.1875	4.000	C35352	47.20	C05892	95.70	NEW!
3/16	.1875	1.000	.1875	6.000	C32027	55.70	C98058	107.20	NEW!
#11	.1910	1.000	.1910	4.000	C16088	49.50	C35710	105.00	NEW!
#11	.1910	1.000	.1910	6.000	C22738	56.10	C35282	114.60	NEW!
#10	.1935	1.000	.1935	4.000	C84675	49.50	C14987	105.00	NEW!
#10	.1935	1.000	.1935	6.000	C16073	56.10	C14774	114.60	NEW!
#8	.1990	1.000	.1990	4.000	C65656	49.50	C09810	105.00	NEW!
#8	.1990	1.000	.1990	6.000	C48018	56.10	C57354	114.60	NEW!

continued on next page

NEW

CFRP Drills (cont.)

continued from previous page

	Size	Diameter D ₁	Length of Flute L ₂	Shank Diameter D ₂	Overall Length L ₁	Uncoated		CVD Coated	
						Tool #	Price	Tool #	Price
NEW!	#7	.2010	1.000	.2010	4.000	C23268	49.50	C39173	105.00
NEW!	#7	.2010	1.000	.2010	6.000	C10990	56.10	C58866	114.60
NEW!	13/64	.2031	1.000	.2031	4.000	C68347	49.50	C47335	105.00
NEW!	13/64	.2031	1.000	.2031	6.000	C33639	56.10	C09621	114.60
NEW!	7/32	.2188	1.000	.2188	4.000	C35701	49.50	C21029	105.00
NEW!	7/32	.2188	1.000	.2188	6.000	C37475	56.10	C94537	114.60
NEW!	#1	.2280	1.000	.2280	4.000	C37392	55.30	C61021	110.80
NEW!	#1	.2280	1.000	.2280	6.000	C06658	62.40	C77600	120.90
NEW!	A	.2340	1.000	.2340	4.000	C86422	55.30	C49745	110.80
NEW!	A	.2340	1.000	.2340	6.000	C34097	62.40	C72711	120.90
NEW!	B	.2380	1.000	.2380	4.000	C40740	55.30	C28404	110.80
NEW!	B	.2380	1.000	.2380	6.000	C04871	62.40	C39234	120.90
NEW!	1/4	.2500	1.000	.2500	4.000	C80092	55.30	C77064	110.80
NEW!	1/4	.2500	1.000	.2500	6.000	C27026	62.40	C51001	120.90
NEW!	5/16	.3125	1.000	.3125	4.000	C89859	60.20	C72275	125.00
NEW!	5/16	.3125	1.000	.3125	6.000	C44598	69.80	C05701	137.60

CFRP Drills



NEW ITEMS

Helical Step Drills

- Proprietary multi-stepped nose design spreads out load, eliminating delamination and burr on exit
- Designed to produce tight toleranced holes with minimal tool pressure
- Suitable for use in a wide range of composites and plastics
- Engineered to improve hole finish
- For use in both hand and CNC operations
- DLC coating for improved lubricity and wear resistance
- True crystalline CVD diamond coating for drastically improved hardness for outstanding abrasion resistance and higher feed rates
- Solid carbide
- Precision manufactured in the USA

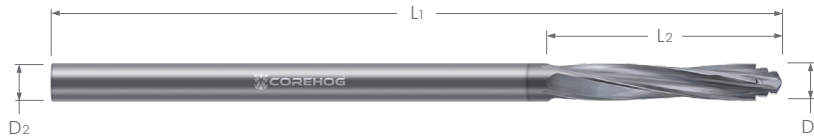

Size	Diameter D1	Length of Flute L2	Shank Diameter D2	Overall Length L1	Uncoated		DLC Coated		CVD Coated		
					Tool #	Price	Tool #	Price	Tool #	Price	
#40	.0980	1.500	.0980	4.000	C85367	51.70	C35505	63.40	C84924	77.10	NEW!
#40	.0980	1.500	.0980	6.000	C77209	61.10	C68838	73.80	C52261	89.50	NEW!
1/8	.1250	1.500	.1250	4.000	C87870	51.70	C71383	63.40	C34308	77.10	NEW!
1/8	.1250	1.500	.1250	6.000	C40706	61.10	C04164	73.80	C00541	89.50	NEW!
#30	.1285	1.500	.1285	4.000	C59188	51.70	C29108	67.80	C16987	100.20	NEW!
#30	.1285	1.500	.1285	6.000	C50598	61.10	C23168	80.60	C97425	112.60	NEW!
9/64	.1406	1.500	.1406	4.000	C88163	56.00	C79132	72.00	C14713	104.50	NEW!
9/64	.1406	1.500	.1406	6.000	C56849	65.90	C56631	85.40	C28071	117.40	NEW!
5/32	.1563	1.500	.1563	4.000	C13592	56.00	C86061	72.00	C36364	104.50	NEW!
5/32	.1563	1.500	.1563	6.000	C49695	65.90	C33360	85.40	C30261	117.40	NEW!
#21	.1590	1.500	.1590	4.000	C95375	56.00	C57044	72.00	C14563	104.50	NEW!
#21	.1590	1.500	.1590	6.000	C88311	65.90	C02440	85.40	C44869	117.40	NEW!
#20	.1610	1.500	.1610	4.000	C58644	56.00	C82592	72.00	C15061	104.50	NEW!
#20	.1610	1.500	.1610	6.000	C55115	65.90	C10058	85.40	C05632	117.40	NEW!
11/64	.1719	1.500	.1719	4.000	C14086	56.00	C89620	72.00	C81780	104.50	NEW!
11/64	.1719	1.500	.1719	6.000	C76710	65.90	C14717	85.40	C62513	117.40	NEW!
3/16	.1875	1.500	.1875	4.000	C35105	56.00	C74364	72.00	C93425	104.50	NEW!
3/16	.1875	1.500	.1875	6.000	C73884	65.90	C54708	85.40	C09271	117.40	NEW!
#11	.1910	1.500	.1910	4.000	C11419	59.40	C05686	77.70	C81070	114.90	NEW!
#11	.1910	1.500	.1910	6.000	C46027	69.80	C33100	96.30	C62229	128.30	NEW!
#10	.1935	1.500	.1935	4.000	C63230	59.40	C27985	77.70	C57449	114.90	NEW!
#10	.1935	1.500	.1935	6.000	C37453	69.80	C41218	96.30	C66309	128.30	NEW!
#8	.1990	1.500	.1990	4.000	C58002	59.40	C70286	77.70	C50121	114.90	NEW!
#8	.1990	1.500	.1990	6.000	C32738	69.80	C97926	96.30	C64046	128.30	NEW!

continued on next page

Helical Step Drills

NEW ITEMS

Helical Step Drills (cont.)

continued from previous page

	Size	Diameter D ₁	Length of Flute L ₂	Shank Diameter D ₂	Overall Length L ₁	Uncoated		DLC Coated		CVD Coated	
						Tool #	Price	Tool #	Price	Tool #	Price
NEW!	#7	.2010	1.500	.2010	4.000	C58438	59.40	C69125	77.70	C14952	114.90
NEW!	#7	.2010	1.500	.2010	6.000	C47246	69.80	C55121	96.30	C72761	128.30
NEW!	13/64	.2031	1.500	.2031	4.000	C87145	59.40	C30409	77.70	C32829	114.90
NEW!	13/64	.2031	1.500	.2031	6.000	C60809	69.80	C38883	96.30	C71076	128.30
NEW!	7/32	.2188	1.500	.2188	4.000	C69648	59.40	C27541	77.70	C06945	114.90
NEW!	7/32	.2188	1.500	.2188	6.000	C17496	69.80	C90585	96.30	C69838	128.30
NEW!	#1	.2280	1.500	.2280	4.000	C54043	65.20	C65411	83.50	C41343	120.70
NEW!	#1	.2280	1.500	.2280	6.000	C90546	76.20	C13267	102.70	C53781	134.70
NEW!	A	.2340	1.500	.2340	4.000	C91646	65.20	C69394	83.50	C94288	120.70
NEW!	A	.2340	1.500	.2340	6.000	C88811	76.20	C09610	102.70	C16381	134.70
NEW!	B	.2380	1.500	.2380	4.000	C11985	65.20	C41108	83.50	C27528	120.70
NEW!	B	.2380	1.500	.2380	6.000	C54115	76.20	C47986	102.70	C74547	134.70
NEW!	1/4	.2500	1.500	.2500	4.000	C72507	65.20	C27827	83.50	C09674	120.70
NEW!	1/4	.2500	1.500	.2500	6.000	C45128	76.20	C09557	102.70	C00081	134.70

Helical Step Drills

Find the Perfect CoreHog Tool For Your Next Job With Product Table Filtering

corehog.com

NEW ITEMS

Tapered Drill Reamers

- Multi-purpose tooling can be used to drill and ream in a one-shot operation
- 4 flute design and special “long nose” geometry greatly reduces delamination by avoiding grabbing or pushing on plies
- Engineered to produce tight toleranced holes in composite laminates
- Suitable for use in a wide range of composites and plastics
- For use in both hand and CNC operations
- DLC coating for improved lubricity and wear resistance
- True crystalline CVD diamond coating for drastically improved hardness for outstanding abrasion resistance and higher feed rates
- Solid carbide
- Precision manufactured in the USA

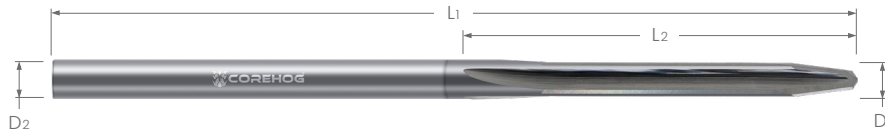

Tapered Drill Reamers

Size	Diameter D1	Length of Flute L2	Shank Diameter D2	Overall Length L1	Flutes	Uncoated		DLC Coated		CVD Coated		
						Tool #	Price	Tool #	Price	Tool #	Price	
#40	.0980	1.500	.0980	4.000	4	C27354	52.80	C94193	64.50	C21169	78.20	NEW!
#40	.0980	1.500	.0980	6.000	4	C31427	62.10	C06810	74.80	C46000	90.50	NEW!
1/8	.1250	1.500	.1250	4.000	4	C20256	52.80	C59607	64.50	C88652	78.20	NEW!
1/8	.1250	1.500	.1250	6.000	4	C43574	62.10	C00635	74.80	C73796	90.50	NEW!
#30	.1285	1.500	.1285	4.000	4	C41022	52.80	C89244	68.90	C75524	101.30	NEW!
#30	.1285	1.500	.1285	6.000	4	C15769	62.10	C18644	81.60	C98673	113.60	NEW!
9/64	.1406	1.500	.1406	4.000	4	C32825	57.10	C11014	73.20	C99631	105.60	NEW!
9/64	.1406	1.500	.1406	6.000	4	C22379	67.00	C65718	86.50	C98135	118.50	NEW!
5/32	.1563	1.500	.1563	4.000	4	C57905	57.10	C07672	73.20	C75652	105.60	NEW!
5/32	.1563	1.500	.1563	6.000	4	C80152	67.00	C82390	86.50	C21504	118.50	NEW!
#21	.1590	1.500	.1590	4.000	4	C10752	57.10	C30152	73.20	C12791	105.60	NEW!
#21	.1590	1.500	.1590	6.000	4	C69671	67.00	C37011	86.50	C52064	118.50	NEW!
#20	.1610	1.500	.1610	4.000	4	C33113	57.10	C94372	73.20	C01097	105.60	NEW!
#20	.1610	1.500	.1610	6.000	4	C37935	67.00	C59795	86.50	C12998	118.50	NEW!
11/64	.1719	1.500	.1719	4.000	4	C35875	57.10	C64976	73.20	C35599	105.60	NEW!
11/64	.1719	1.500	.1719	6.000	4	C31369	67.00	C52684	86.50	C17666	118.50	NEW!
3/16	.1875	1.500	.1875	4.000	4	C97097	57.10	C69813	73.20	C56354	105.60	NEW!
3/16	.1875	1.500	.1875	6.000	4	C84609	67.00	C49028	86.50	C81188	118.50	NEW!
#11	.1910	1.500	.1910	4.000	4	C42964	60.60	C30345	78.90	C30767	116.10	NEW!
#11	.1910	1.500	.1910	6.000	4	C28656	71.00	C24655	97.50	C20580	129.50	NEW!
#10	.1935	1.500	.1935	4.000	4	C31983	60.60	C49894	78.90	C54556	116.10	NEW!
#10	.1935	1.500	.1935	6.000	4	C41707	71.00	C14337	97.50	C91576	129.50	NEW!
#8	.1990	1.500	.1990	4.000	4	C80447	60.60	C14907	78.90	C14190	116.10	NEW!
#8	.1990	1.500	.1990	6.000	4	C41628	71.00	C83244	97.50	C15071	129.50	NEW!

continued on next page

NEW ITEMS

Tapered Drill Reamers (cont.)

continued from previous page

	Size	Diameter		Length of Flute		Shank Diameter	Overall Length	Flutes	Uncoated		DLC Coated		CVD Coated	
		D1	D2	L2	L1				Tool #	Price	Tool #	Price	Tool #	Price
NEW!	#7	.2010	.2010	1.500	4.000	.2010	4.000	4	C97319	60.60	C03844	78.90	C01806	116.10
NEW!	#7	.2010	.2010	1.500	6.000	.2010	6.000	4	C23092	71.00	C69579	97.50	C47929	129.50
NEW!	13/64	.2031	.2031	1.500	4.000	.2031	4.000	4	C82804	60.60	C60542	78.90	C49044	116.10
NEW!	13/64	.2031	.2031	1.500	6.000	.2031	6.000	4	C46915	71.00	C73665	97.50	C77955	129.50
NEW!	7/32	.2188	.2188	1.500	4.000	.2188	4.000	4	C54150	60.60	C78337	78.90	C64938	116.10
NEW!	7/32	.2188	.2188	1.500	6.000	.2188	6.000	4	C21539	71.00	C78353	97.50	C86630	129.50
NEW!	#1	.2280	.2280	1.500	4.000	.2280	4.000	4	C17043	66.50	C95839	84.80	C62355	122.00
NEW!	#1	.2280	.2280	1.500	6.000	.2280	6.000	4	C66989	77.50	C24384	104.00	C78087	136.00
NEW!	A	.2340	.2340	1.500	4.000	.2340	4.000	4	C68577	66.50	C48309	84.80	C91583	122.00
NEW!	A	.2340	.2340	1.500	6.000	.2340	6.000	4	C69742	77.50	C94501	104.00	C10645	136.00
NEW!	B	.2380	.2380	1.500	4.000	.2380	4.000	4	C54695	66.50	C02381	84.80	C79821	122.00
NEW!	B	.2380	.2380	1.500	6.000	.2380	6.000	4	C31256	77.50	C38859	104.00	C19172	136.00
NEW!	1/4	.2500	.2500	1.500	4.000	.2500	4.000	4	C43238	66.50	C14527	84.80	C67534	122.00
NEW!	1/4	.2500	.2500	1.500	6.000	.2500	6.000	4	C52627	77.50	C22303	104.00	C24072	136.00

NEW ITEMS

8 Facet Drills

- 8 Facet design efficiently spreads out tool pressure throughout the cut, reducing delamination on exit
- High strength design maximizes MRR
- Suitable for use in a wide range of composites and plastics
- For use in hand and CNC operations
- DLC coating for improved lubricity and wear resistance
- True crystalline CVD diamond coating for drastically improved hardness for outstanding abrasion resistance and higher feed rates
- Solid carbide
- Precision manufactured in the USA

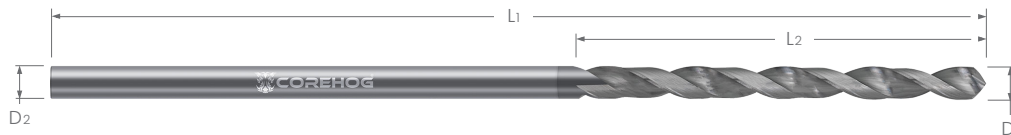

Size	Diameter D1	Length of Flute L2	Shank Diameter D2	Overall Length L1	Uncoated		DLC Coated		CVD Coated		
					Tool #	Price	Tool #	Price	Tool #	Price	
#40	.0980	1.500	.0980	4.000	C14893	45.40	C25857	57.10	C47552	70.80	NEW!
#40	.0980	1.500	.0980	6.000	C96799	54.30	C62900	67.00	C76268	82.70	NEW!
1/8	.1250	1.500	.1250	4.000	C97275	45.40	C25247	57.10	C30894	70.80	NEW!
1/8	.1250	1.500	.1250	6.000	C58920	54.30	C72221	67.00	C24995	82.70	NEW!
#30	.1285	1.500	.1285	4.000	C17912	45.40	C14416	61.50	C27340	93.90	NEW!
#30	.1285	1.500	.1285	6.000	C51710	54.30	C00455	73.80	C84730	105.80	NEW!
9/64	.1406	1.500	.1406	4.000	C54951	49.10	C20409	65.20	C39105	97.60	NEW!
9/64	.1406	1.500	.1406	6.000	C64074	58.60	C51622	78.10	C45266	110.10	NEW!
5/32	.1563	1.500	.1563	4.000	C47378	49.10	C25142	65.20	C28957	97.60	NEW!
5/32	.1563	1.500	.1563	6.000	C30144	58.60	C54798	78.10	C35544	110.10	NEW!
#21	.1590	1.500	.1590	4.000	C54592	49.10	C31994	65.20	C77738	97.60	NEW!
#21	.1590	1.500	.1590	6.000	C84101	58.60	C49679	78.10	C41803	110.10	NEW!
#20	.1610	1.500	.1610	4.000	C48046	49.10	C66738	65.20	C77000	97.60	NEW!
#20	.1610	1.500	.1610	6.000	C53804	58.60	C93520	78.10	C16433	110.10	NEW!
11/64	.1719	1.500	.1719	4.000	C82255	49.10	C53163	65.20	C41817	97.60	NEW!
11/64	.1719	1.500	.1719	6.000	C13482	58.60	C60041	78.10	C31463	110.10	NEW!
3/16	.1875	1.500	.1875	4.000	C41314	49.10	C88822	65.20	C55237	97.60	NEW!
3/16	.1875	1.500	.1875	6.000	C80427	58.60	C97047	78.10	C26496	110.10	NEW!
#11	.1910	1.500	.1910	4.000	C90406	52.10	C35236	70.40	C74670	107.60	NEW!
#11	.1910	1.500	.1910	6.000	C38899	62.10	C37125	88.60	C85169	120.60	NEW!
#10	.1935	1.500	.1935	4.000	C63605	52.10	C57439	70.40	C22504	107.60	NEW!
#10	.1935	1.500	.1935	6.000	C14935	62.10	C60241	88.60	C20727	120.60	NEW!
#8	.1990	1.500	.1990	4.000	C88736	52.10	C78564	70.40	C14145	107.60	NEW!
#8	.1990	1.500	.1990	6.000	C37663	62.10	C52858	88.60	C67302	120.60	NEW!

continued on next page

see page 64 for 8 Facet Drills - PCD

NEW ITEMS

8 Facet Drills (cont.)

continued from previous page

	Size	Diameter D ₁	Length of Flute L ₂	Shank Diameter D ₂	Overall Length L ₁	Uncoated		DLC Coated		CVD Coated	
						Tool #	Price	Tool #	Price	Tool #	Price
NEW!	#7	.2010	1.500	.2010	4.000	C16115	52.10	C37267	70.40	C54733	107.60
NEW!	#7	.2010	1.500	.2010	6.000	C23344	62.10	C41014	88.60	C49739	120.60
NEW!	13/64	.2031	1.500	.2031	4.000	C90415	52.10	C09992	70.40	C93082	107.60
NEW!	13/64	.2031	1.500	.2031	6.000	C55016	62.10	C52227	88.60	C88033	120.60
NEW!	7/32	.2188	1.500	.2188	4.000	C33317	52.10	C31435	70.40	C29906	107.60
NEW!	7/32	.2188	1.500	.2188	6.000	C59892	62.10	C24117	88.60	C40167	120.60
NEW!	#1	.2280	1.500	.2280	4.000	C90403	57.20	C97708	75.50	C91760	112.70
NEW!	#1	.2280	1.500	.2280	6.000	C14929	67.70	C59584	94.20	C93672	126.20
NEW!	A	.2340	1.500	.2340	4.000	C99526	57.20	C16811	75.50	C82039	112.70
NEW!	A	.2340	1.500	.2340	6.000	C94961	67.70	C70323	94.20	C49297	126.20
NEW!	B	.2380	1.500	.2380	4.000	C48696	57.20	C55732	75.50	C40428	112.70
NEW!	B	.2380	1.500	.2380	6.000	C98607	67.70	C95016	94.20	C87310	126.20
NEW!	1/4	.2500	1.500	.2500	4.000	C78583	57.20	C54478	75.50	C49318	112.70
NEW!	1/4	.2500	1.500	.2500	6.000	C50597	67.70	C44958	94.20	C12988	126.20

see page 64 for 8 Facet Drills - PCD



**Build & Send Shopping Carts Directly
to Your Distributor or Purchasing Agent**

corehog.com

8 Facet Drills

8 Facet Drills – PCD Diamond

- PCD diamond brazed onto solid carbide body for significant improvement in tool life
- 8 Facet design efficiently spreads out tool pressure throughout the cut, reducing delamination on exit
- High strength design maximizes MRR
- Suitable for use in a wide range of composites and plastics
- Precision manufactured in Italy

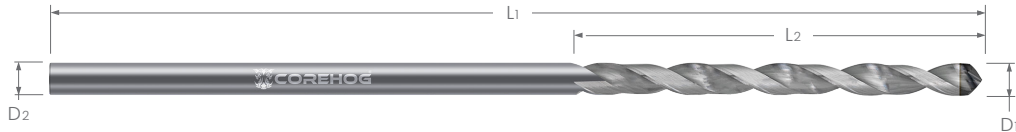

Size	Diameter D1	Length of Flute L2	Shank Diameter D2	Overall Length L1	PCD Diamond	
					Tool #	Price
#40	.0980	1.500	.0980	4.000	C90396	534.20
#40	.0980	1.500	.0980	6.000	C38258	540.00
1/8	.1250	1.500	.1250	4.000	C49330	609.30
1/8	.1250	1.500	.1250	6.000	C38653	617.90
#30	.1285	1.500	.1285	4.000	C85685	609.30
#30	.1285	1.500	.1285	6.000	C25332	617.90
9/64	.1406	1.500	.1406	4.000	C15800	641.00
9/64	.1406	1.500	.1406	6.000	C76164	649.70
5/32	.1563	1.500	.1563	4.000	C19906	489.20
5/32	.1563	1.500	.1563	6.000	C50071	498.70
#21	.1590	1.500	.1590	4.000	C99483	511.40
#21	.1590	1.500	.1590	6.000	C38093	520.90
#20	.1610	1.500	.1610	4.000	C78394	511.40
#20	.1610	1.500	.1610	6.000	C76345	520.90
11/64	.1719	1.500	.1719	4.000	C59109	511.40
11/64	.1719	1.500	.1719	6.000	C71236	520.90
3/16	.1875	1.500	.1875	4.000	C42430	546.30
3/16	.1875	1.500	.1875	6.000	C42410	562.20
#11	.1910	1.500	.1910	4.000	C17060	546.30
#11	.1910	1.500	.1910	6.000	C82350	562.20
#10	.1935	1.500	.1935	4.000	C98671	546.30
#10	.1935	1.500	.1935	6.000	C25422	562.20
#8	.1990	1.500	.1990	4.000	C57410	565.40
#8	.1990	1.500	.1990	6.000	C84739	581.30

continued on next page

[see page 62 for uncoated 8 Facet Drills](#)

8 Facet Drills – PCD Diamond (cont.)

continued from previous page

Size	Diameter D ₁	Length of Flute L ₂	Shank Diameter D ₂	Overall Length L ₁	PCD Diamond	
					Tool #	Price
#7	.2010	1.500	.2010	4.000	C29982	565.40
#7	.2010	1.500	.2010	6.000	C54216	581.30
13/64	.2031	1.500	.2031	4.000	C34314	565.40
13/64	.2031	1.500	.2031	6.000	C18210	581.30
7/32	.2188	1.500	.2188	4.000	C85129	587.60
7/32	.2188	1.500	.2188	6.000	C72004	603.50
#1	.2280	1.500	.2280	4.000	C72387	587.60
#1	.2280	1.500	.2280	6.000	C70412	603.50
A	.2340	1.500	.2340	4.000	C80253	587.60
A	.2340	1.500	.2340	6.000	C43657	603.50
B	.2380	1.500	.2380	4.000	C98957	625.80
B	.2380	1.500	.2380	6.000	C51757	641.60
1/4	.2500	1.500	.2500	4.000	C68709	625.80
1/4	.2500	1.500	.2500	6.000	C84791	641.60

[see page 62 for uncoated 8 Facet Drills](#)

NEW ITEMS

Dagger Drills

- An ideal choice for hand drilling composites in assembly applications
- Can be reground without modifying point geometry
- Suitable for use in a wide range of composites
- Can also be used in CNC operations for added versatility
- DLC coating for improved lubricity and wear resistance
- Solid carbide
- Precision manufactured in the USA

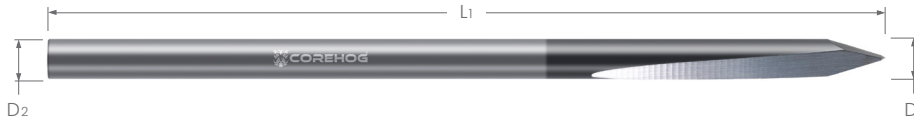

Size	Diameter D1	Shank Diameter D2	Overall Length L1	Uncoated		DLC Coated		
				Tool #	Price	Tool #	Price	
#40	.0980	.0980	4.000	C94774	43.60	C54513	49.40	NEW!
#40	.0980	.0980	6.000	C60051	52.40	C86727	58.60	NEW!
1/8	.1250	.1250	4.000	C73794	43.60	C48573	49.40	NEW!
1/8	.1250	.1250	6.000	C41171	52.40	C53673	58.60	NEW!
#30	.1285	.1285	4.000	C26024	41.40	C33689	49.30	NEW!
#30	.1285	.1285	6.000	C85516	49.00	C58943	58.60	NEW!
9/64	.1406	.1406	4.000	C73344	45.40	C74783	53.30	NEW!
9/64	.1406	.1406	6.000	C21761	53.60	C55142	63.20	NEW!
5/32	.1563	.1563	4.000	C48825	45.40	C60040	53.30	NEW!
5/32	.1563	.1563	6.000	C59872	53.60	C35069	63.20	NEW!
#21	.1590	.1590	4.000	C33264	45.40	C24478	53.30	NEW!
#21	.1590	.1590	6.000	C41070	53.60	C19253	63.20	NEW!
#20	.1610	.1610	4.000	C85298	45.40	C79990	53.30	NEW!
#20	.1610	.1610	6.000	C79913	53.60	C39287	63.20	NEW!
11/64	.1719	.1719	4.000	C50934	45.40	C22739	53.30	NEW!
11/64	.1719	.1719	6.000	C79416	53.60	C74357	63.20	NEW!
3/16	.1875	.1875	4.000	C32275	45.40	C80957	53.30	NEW!
3/16	.1875	.1875	6.000	C23050	53.60	C94739	63.20	NEW!
#11	.1910	.1910	4.000	C38580	47.60	C81447	56.60	NEW!
#11	.1910	.1910	6.000	C71797	53.90	C85505	66.90	NEW!
#10	.1935	.1935	4.000	C29713	47.60	C26167	56.60	NEW!
#10	.1935	.1935	6.000	C70854	53.90	C44812	66.90	NEW!
#8	.1990	.1990	4.000	C99221	47.60	C58352	56.60	NEW!
#8	.1990	.1990	6.000	C49796	53.90	C15288	66.90	NEW!

continued on next page

NEW ITEMS

Dagger Drills (cont.)

continued from previous page

	Size	Diameter D ₁	Shank Diameter D ₂	Overall Length L ₁	Uncoated		DLC Coated	
					Tool #	Price	Tool #	Price
NEW!	#7	.2010	.2010	4.000	C75443	47.60	C92113	56.60
NEW!	#7	.2010	.2010	6.000	C36177	53.90	C93241	66.90
NEW!	13/64	.2031	.2031	4.000	C49487	47.60	C66627	56.60
NEW!	13/64	.2031	.2031	6.000	C26465	53.90	C84617	66.90
NEW!	7/32	.2188	.2188	4.000	C22977	47.60	C97767	56.60
NEW!	7/32	.2188	.2188	6.000	C47529	53.90	C82266	66.90
NEW!	#1	.2280	.2280	4.000	C95166	53.20	C19980	62.20
NEW!	#1	.2280	.2280	6.000	C40676	60.00	C95914	73.00
NEW!	A	.2340	.2340	4.000	C57581	53.20	C72944	62.20
NEW!	A	.2340	.2340	6.000	C45685	60.00	C93784	73.00
NEW!	B	.2380	.2380	4.000	C91642	53.20	C10495	62.20
NEW!	B	.2380	.2380	6.000	C08141	60.00	C53020	73.00
NEW!	1/4	.2500	.2500	4.000	C03988	53.20	C87771	62.20
NEW!	1/4	.2500	.2500	6.000	C75824	60.00	C44308	73.00

Check Stock of up to 50 Tools at Once to Simplify the Order Planning Process

corehog.com

Countersinks PCD Diamond

- Provides excellent performance in abrasive materials like CFRP, fiberglass, and Kevlar®
- Achieve up to 50x the tool life over high speed steel or carbide tools
- Superior tool life
- For use in both hand and CNC operations
- PCD diamond brazed onto solid carbide body for outstanding microhardness and abrasion resistance for significant improvement in tool life
- Precision manufactured in Italy

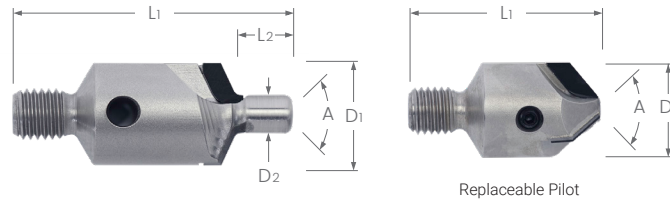

Included Angle A	Diameter D1	Pilot Diameter D2	Pilot Length L2	Shank Thread	Flutes	Hole Diameter	Overall Length L1	PCD Diamond	
								Tool #	Price
100°	.5000	.188	.200	1/4-28	2	-	1.365	C28471	236.10
	.5000	.188	.200	1/4-28	3	-	1.365	C73531	284.40
	.5000	.199	.200	1/4-28	2	-	1.365	C14206	236.10
	.5000	.199	.200	1/4-28	3	-	1.365	C74331	284.40
	.5000	.248	.200	1/4-28	2	-	1.365	C61588	236.10
	.5000	.248	.200	1/4-28	3	-	1.365	C60696	284.40
	.5000	Replaceable	-	1/4-28	2	.094	1.365	C72733	252.80
	.5000	Replaceable	-	1/4-28	3	.094	1.365	C15147	308.30
130°	.5000	.188	.200	1/4-28	2	-	1.365	C80597	236.10
	.5000	.188	.200	1/4-28	3	-	1.365	C49699	284.40
	.5000	.199	.200	1/4-28	2	-	1.365	C36217	236.10
	.5000	.199	.200	1/4-28	3	-	1.365	C75796	284.40
	.5000	.248	.200	1/4-28	2	-	1.365	C93938	236.10
	.5000	.248	.200	1/4-28	3	-	1.365	C23165	284.40
	.5000	Replaceable	-	1/4-28	2	.094	1.365	C18815	252.80
	.5000	Replaceable	-	1/4-28	3	.094	1.365	C96616	308.30

Countersinks Interchangeable Pilot

- Interchangeable pilot design ensures countersink is concentric around the hole
- Interchangeable design allows for added versatility
- Provides excellent performance in abrasive materials like CFRP, fiberglass, and Kevlar®
- Specially designed for aircraft manufacturing with use of handheld pneumatic drill
- Steel
- Precision manufactured in the USA



Pilot Diameter D ₁	Pilot Length	Shank Diameter D ₂	Uncoated	
			Tool #	Price
.0980	.200	.0940	C87756	19.30
.1250	.200	.0940	C88104	19.30
.1285	.200	.0940	C93928	19.30
.1590	.200	.0940	C88548	19.30
.1610	.200	.0940	C20350	19.30
.1850	.200	.0940	C13702	21.80
.1875	.200	.0940	C59242	21.80
.1890	.200	.0940	C43980	21.80
.1935	.200	.0940	C50171	21.80
.1990	.200	.0940	C18803	21.80
.2460	.200	.0940	C62451	22.70
.2500	.200	.0940	C18074	22.70
.2610	.200	.0940	C92035	22.70

Reference # to Tool # Conversion Index

To simplify the tool selection process for CoreHog customers, we have standardized our tool numbers. However, you can still find your tool by looking up a legacy Reference Number in the chart below. Simply search for your Reference Number to find its new Tool Number, and catalog page.

Reference #	Tool #	Pg.	Reference #	Tool #	Pg.	Reference #	Tool #	Pg.
100PCD	C99963	44	1BACH-6	C90082	11	25CFRU1.00MAX	C36367	40
100PCDB	C98151	45	1CFA	C67352	23	25CFRU1.00MAX2F	C49457	41
100X312CHRBPCA	C95727	30	1CH	C20991	8	25CFRU1.00MAXDP	C60093	42
10MCS	C37473	13	1CH-6	C84163	8	25CFRU2F	C75739	37
10MCSC	C60175	13	1CHLH	C42937	27	25CFRUCVD	C10057	35
10MCST	C68738	13	1CHLH-6	C25658	27	25CFRUCVD2F	C30903	37
10MH	C74686	14	1CS	C12789	15	25CFRUCVDDP	C61695	38
125CFRU	C29759	35	1CSC	C11921	15	25CFRUDP	C52495	38
125CFRU2F	C62250	37	1CSC-MTK	C17155	21	25CFRUMAX	C59526	40
125CFRUCVD	C25760	35	1CS-MTK	C15602	21	25CFRUMAX2F	C91247	41
125CFRUCVD2F	C28064	37	1CST	C53187	15	25CFRUMAXDP	C76993	42
125CFRUCVDDP	C41492	38	1CST-MTK	C12535	21	25CH	C12463	8
125CFRUDP	C97821	38	1HA	C53955	16	25CH-3	C61211	8
125PCD	C74984	44	1HA-CARB	C11495*	16	25CH-4	C13568	8
125PCDB	C66271	45	20MMBACH	C59471	11	25CH-6	C93954	8
12MH	C32428	16	20MMCH	C68953	8	25CHF	C65069	10
12MMA	C84383	20	2500FRB2FC0	C87510	49	25CHF-4	C51558	10
12MMCFA	C24452	23	2500FRB2FC7	C19396	49	25CHLH	C23956	27
15CFA	C20736	23	2500FRB2FXLC0	C72576	49	25CHLH-4	C31748	27
15CS	C34019	22	2500FRB2FXLC7	C75176	49	25CHLH-6	C28371	27
15CSC	C22937	22	2500FRBDPC0	C17331	50	25PCD	C79748	44
15CST	C85199	22	2500FRBDPC7	C39339	50	25PCDB	C27976	45
16MMA	C26433	20	2500FRBDPXL0	C80150	50	25SPC	C53435	28
16MMBACH	C41998	11	2500FRBDPXL7	C72397	50	25SPC-1.25	C36623	28
16MMCH	C42950	8	2500FRBECC0	C70016	48	25SPCD	C15485	28
16MMHA-CARB	C51776*	16	2500FRBECC7	C36346	48	2A	C46720	20
17RZR	C38452	16	2500FRBECXLC0	C28344	48	2AW	C69287	20
17RZR375	C23037	16	2500FRBECXLC7	C88891	48	2CFA	C14216	23
17RZRXL	C20657	16	250TED4CMPR-TR1.13L3.0-C9	C43415	28	2CFS	C87352	22
1875CFRU	C47397	35	25BACH	C37430	11	2CFSC	C62872	22
1875CFRU2F	C91130	37	25BACH-3	C16770	11	2CFST	C41900	22
1875CFRUCVD	C32315	35	25BACH-4	C11348	11	2CS	C12149	17
1875CFRUCVD2F	C28469	37	25BACH-6	C60420	11	2CSC	C40544	17
1875CFRUCVDDP	C68364	38	25CFHFM	C23730	34	2CS-NMX	C44070	17
1875CFRUDP	C61895	38	25CFHFM1.00L3.00C8CB	C90209	33	2CST	C37261	17
1875CFRUMAX	C16639	40	25CFHFMCVDD	C73272	34	2CSW	C52001	17
1875CFRUMAX2F	C69823	41	25CFRD	C73670*	36	2H	C21117	19
1875CFRUMAXDP	C11591	42	25CFRDCVD	C95468	36	2H-CARB	C78723	18
1875PCD	C79979	44	25CFRU	C17487	35	2HLG	C30885	19
1875PCDB	C64310	45	25CFRU1.00L3.00C8	C23690	35	2HLG-3DEG	C78023*	19
1BACH	C34824	11				2HLG-CARB	C52278	18

Reference # to Tool # Conversion Index

Reference #	Tool #	Pg.	Reference #	Tool #	Pg.	Reference #	Tool #	Pg.
3125FRB2FC0	C50116	49	3CSW	C19254	17	5CS	C24361	13
3125FRB2FC7	C11470	49	3H	C84212	19	5CSC	C16343	13
3125FRBDPC0	C85678	50	45A	C79286	20	5CS-CARB	C81787	15
3125FRBDPC7	C63083	50	45AW	C83666	20	5CST	C27014	13
3125FRBECC0	C84729	48	45CS	C84541	17	5H	C81725	14
3125FRBECC7	C21464	48	45CSC	C25382	17	5MCS	C39016*	13
3750FRB2FC0	C90419	49	45CS-NMX	C99863	17	5PCCFRU	C32952	31
3750FRB2FC7	C89565	49	45CST	C87837	17	5PCCFRUCVD	C22196	31
3750FRBDPC0	C36362	50	45CSW	C86059	17	5PCD	C12470	44
3750FRBDPC7	C30807	50	45H	C72191	19	5PCDB	C90424	45
3750FRBECC0	C67528	48	45H-CARB	C21741	18	5SPC	C76408	28
3750FRBECC7	C54430	48	5000FRB2FC0	C48175	49	5WA-6-TC	C75687	26
375BACH	C70972	11	5000FRB2FC7	C71414	49	5WCSC-TC	C24773	25
375CFHFM1.25L3.00C8CB	C30440	33	5000FRBDPC0	C74177	50	5WCS-TC	C78051	25
375CFHFM2.00L4.00C8CB	C45627	33	5000FRBDPC7	C69523	50	63A	C87981	20
375CFHFMCVDL3.0	C84996	34	5000FRBECC0	C57182	48	63AEXT	C24685	20
375CFHFML3.0	C68988	34	5000FRBECC7	C63031	48	63CS	C55856	17
375CFRDCVDL3.0	C87132	36	5APCA	C41516	31	63CSC	C85026	17
375CFRDL3.0	C66310	36	5BACH	C28059	11	63CS-NMX	C70889	17
375CFRU2FL3.0	C18480	37	5BACH-6	C95202	11	63CST	C70694	17
375CFRUCVD2FL3.0	C61622	37	5CFHFM	C70633	34	63CSW	C20615	17
375CFRUCVD2FL4.0	C75207	37	5CFHFM1.50L4.00C8	C67224	34	63H	C80551	19
375CFRUCVDDPL3.0	C35013	38	5CFHFM1.50L4.00C8CB	C33933	33	63H-CARB	C16317	18
375CFRUCVDDPL4.0	C69764	38	5CFHFMCVD	C24389	34	63HLG	C62919	19
375CFRUCVDL3.0	C90400	35	5CFRD	C20235	36	63HLG_CARB	C42917	18
375CFRUCVDL4.0	C61465	35	5CFRDCVD	C96237	36	75BACH	C69424	11
375CFRUDPL3.0	C23154	38	5CFRU	C85755	35	75BACH-6	C50318	11
375CFRUL3.0	C22375	35	5CFRU2F	C26546	37	75BACH-XL	C96800	11
375CFRUMAX	C86072	40	5CFRUCVD	C85758	35	75CFRD	C69001	36
375CFRUMAX2F	C14978	41	5CFRUCVD2F	C58718	37	75CFRDCVD	C97846	36
375CFRUMAXDP	C18724	42	5CFRUCVDDP	C87478	38	75CFRU	C35161	35
375CH	C21583	8	5CFRUDP	C90390	38	75CFRUCVD	C69497	35
375CHLH	C46610	27	5CFRUMAX	C60516	40	75CH	C99519	8
375PCD	C82527	44	5CFRUMAX2F	C37776	41	75CH-6	C84370	8
375PCDB	C30325	45	5CFRUMAX2FL4.00C8	C39307	41	75CHF	C21033	10
375SPC	C22069	28	5CFRUMAXDP	C18336	42	75CHF-6	C37889	10
375SPC-1.25	C34819	28	5CFRUMAXDPL4.00C8	C83530	42	75CHLH	C94437	27
3CF5	C26818	22	5CFRUMAXL4.00C8	C81281	40	75CHLH-6	C33517	27
3CF5C	C50484	22	5CH	C61071	8	75CH-XL	C62278	8
3CF5T	C23286	22	5CH-6	C93134	8	75CS	C36226	15
3CS	C64415	17	5CHF	C61225	10	75CSC	C59966	15
3CSC	C54747	17	5CHLH	C16350	27	75CSC-MTK	C67092	21
3CS-NMX	C12028	17	5CHLH-6	C31093	27	75CS-MTK	C33276	21
3CST	C58561	17	5CHRBCL	C54641*	29	75CST	C15072	15

Reference # to Tool # Conversion Index

Reference #	Tool #	Pg.	Reference #	Tool #	Pg.	Reference #	Tool #	Pg.
75CST-MTK	C21155	21	8FDR2031C0-6	C55016	63	8FDRPCD2340-6	C43657	65
75MMCF A	C99465	23	8FDR2188C0-4	C33317	63	8FDRPCD2380-4	C98957	65
75MMCF S	C60434	22	8FDR2188C0-6	C59892	63	8FDRPCD2380-6	C51757	65
75MMCF SC	C39158	22	8FDR2280C0-4	C90403	63	8FDRPCD2500-4	C68709	65
75MMCF ST	C42038	22	8FDR2280C0-6	C14929	63	8FDRPCD2500-6	C84791	65
75PCD	C31980	44	8FDR2340C0-4	C99526	63	CHSAW250MMSB	C68081	24
75PCDB	C94917	45	8FDR2340C0-6	C94961	63	CHSAW300MMSB	C76240	24
75WA-6-TC	C45203	26	8FDR2380C0-4	C48696	63	CSNK1002FD500P188	C28471	68
75WCSC-TC	C16457	25	8FDR2380C0-6	C98607	63	CSNK1002FD500P199	C14206	68
75WCS-TC	C64381	25	8FDR2500C0-4	C78583	63	CSNK1002FD500P248	C61588	68
875X16CHRBPCA	C18949	30	8FDR2500C0-6	C50597	63	CSNK1002FD500RP	C72733	68
875X21CHRBPCA	C15104	30	8FDRPCD0980-4	C90396	64	CSNK1003FD500P188	C73531	68
875X25CHRBPCA	C62536	30	8FDRPCD0980-6	C38258	64	CSNK1003FD500P199	C74331	68
875X38CHRBPCA	C18259	30	8FDRPCD1250-4	C49330	64	CSNK1003FD500P248	C60696	68
875X45CHRBPCA	C27240	30	8FDRPCD1250-6	C38653	64	CSNK1003FD500RP	C15147	68
875X475CHRBPCA	C91505	30	8FDRPCD1285-4	C85685	64	CSNK1302FD500P188	C80597	68
875X50CHRBPCA	C74679	30	8FDRPCD1285-6	C25332	64	CSNK1302FD500P199	C36217	68
8FDR0980C0-4	C14893	62	8FDRPCD1406-4	C15800	64	CSNK1302FD500P248	C93938	68
8FDR0980C0-6	C96799	62	8FDRPCD1406-6	C76164	64	CSNK1302FD500RP	C18815	68
8FDR1250C0-4	C97275	62	8FDRPCD1563-4	C19906	64	CSNK1303FD500P188	C49699	68
8FDR1250C0-6	C58920	62	8FDRPCD1563-6	C50071	64	CSNK1303FD500P199	C75796	68
8FDR1285C0-4	C17912	62	8FDRPCD1590-4	C99483	64	CSNK1303FD500P248	C23165	68
8FDR1285C0-6	C51710	62	8FDRPCD1590-6	C38093	64	CSNK1303FD500RP	C96616	68
8FDR1406C0-4	C54951	62	8FDRPCD1610-4	C78394	64	CSNKPILOT0980	C87756	69
8FDR1406C0-6	C64074	62	8FDRPCD1610-6	C76345	64	CSNKPILOT1250	C88104	69
8FDR1563C0-4	C47378	62	8FDRPCD1719-4	C59109	64	CSNKPILOT1285	C93928	69
8FDR1563C0-6	C30144	62	8FDRPCD1719-6	C71236	64	CSNKPILOT1590	C88548	69
8FDR1590C0-4	C54592	62	8FDRPCD1875-4	C42430	64	CSNKPILOT1610	C20350	69
8FDR1590C0-6	C84101	62	8FDRPCD1875-6	C42410	64	CSNKPILOT1850	C13702	69
8FDR1610C0-4	C48046	62	8FDRPCD1910-4	C17060	64	CSNKPILOT1875	C59242	69
8FDR1610C0-6	C53804	62	8FDRPCD1910-6	C82350	64	CSNKPILOT1890	C43980	69
8FDR1719C0-4	C82255	62	8FDRPCD1935-4	C98671	64	CSNKPILOT1935	C50171	69
8FDR1719C0-6	C13482	62	8FDRPCD1935-6	C25422	64	CSNKPILOT1990	C18803	69
8FDR1875C0-4	C41314	62	8FDRPCD1990-4	C57410	64	CSNKPILOT2460	C62451	69
8FDR1875C0-6	C80427	62	8FDRPCD1990-6	C84739	64	CSNKPILOT2500	C18074	69
8FDR1910C0-4	C90406	62	8FDRPCD2010-4	C29982	65	CSNKPILOT2610	C92035	69
8FDR1910C0-6	C38899	62	8FDRPCD2010-6	C54216	65	DGRDR0980-4	C54513	66
8FDR1935C0-4	C63605	62	8FDRPCD2031-4	C34314	65	DGRDR0980-6	C86727	66
8FDR1935C0-6	C14935	62	8FDRPCD2031-6	C18210	65	DGRDR1250-4	C48573	66
8FDR1990C0-4	C88736	62	8FDRPCD2188-4	C85129	65	DGRDR1250-6	C53673	66
8FDR1990C0-6	C37663	62	8FDRPCD2188-6	C72004	65	DGRDR1285-4	C33689	66
8FDR2010C0-4	C16115	63	8FDRPCD2280-4	C72387	65	DGRDR1285-6	C58943	66
8FDR2010C0-6	C23344	63	8FDRPCD2280-6	C70412	65	DGRDR1406-4	C74783	66
8FDR2031C0-4	C90415	63	8FDRPCD2340-4	C80253	65	DGRDR1406-6	C55142	66

Reference # to Tool # Conversion Index

Reference #	Tool #	Pg.	Reference #	Tool #	Pg.	Reference #	Tool #	Pg.
DGRDR1563-4	C60040	66	STDRMR1590C0-4	C95375	58	TPRMR1719C0-6	C31369	60
DGRDR1563-6	C35069	66	STDRMR1590C0-6	C88311	58	TPRMR1875C0-4	C97097	60
DGRDR1590-4	C24478	66	STDRMR1610C0-4	C58644	58	TPRMR1875C0-6	C84609	60
DGRDR1590-6	C19253	66	STDRMR1610C0-6	C55115	58	TPRMR1910C0-4	C42964	60
DGRDR1610-4	C79990	66	STDRMR1719C0-4	C14086	58	TPRMR1910C0-6	C28656	60
DGRDR1610-6	C39287	66	STDRMR1719C0-6	C76710	58	TPRMR1935C0-4	C31983	60
DGRDR1719-4	C22739	66	STDRMR1875C0-4	C35105	58	TPRMR1935C0-6	C41707	60
DGRDR1719-6	C74357	66	STDRMR1875C0-6	C73884	58	TPRMR1990C0-4	C80447	60
DGRDR1875-4	C80957	66	STDRMR1910C0-4	C11419	58	TPRMR1990C0-6	C41628	60
DGRDR1875-6	C94739	66	STDRMR1910C0-6	C46027	58	TPRMR2010C0-4	C97319	61
DGRDR1910-4	C81447	66	STDRMR1935C0-4	C63230	58	TPRMR2010C0-6	C23092	61
DGRDR1910-6	C85505	66	STDRMR1935C0-6	C37453	58	TPRMR2031C0-4	C82804	61
DGRDR1935-4	C26167	66	STDRMR1990C0-4	C58002	58	TPRMR2031C0-6	C46915	61
DGRDR1935-6	C44812	66	STDRMR1990C0-6	C32738	58	TPRMR2188C0-4	C54150	61
DGRDR1990-4	C58352	66	STDRMR2010C0-4	C58438	59	TPRMR2188C0-6	C21539	61
DGRDR1990-6	C15288	66	STDRMR2010C0-6	C47246	59	TPRMR2280C0-4	C17043	61
DGRDR2010-4	C92113	67	STDRMR2031C0-4	C87145	59	TPRMR2280C0-6	C66989	61
DGRDR2010-6	C93241	67	STDRMR2031C0-6	C60809	59	TPRMR2340C0-4	C68577	61
DGRDR2031-4	C66627	67	STDRMR2188C0-4	C69648	59	TPRMR2340C0-6	C69742	61
DGRDR2031-6	C84617	67	STDRMR2188C0-6	C17496	59	TPRMR2380C0-4	C54695	61
DGRDR2188-4	C97767	67	STDRMR2280C0-4	C54043	59	TPRMR2380C0-6	C31256	61
DGRDR2188-6	C82266	67	STDRMR2280C0-6	C90546	59	TPRMR2500C0-4	C43238	61
DGRDR2280-4	C19980	67	STDRMR2340C0-4	C91646	59	TPRMR2500C0-6	C52627	61
DGRDR2280-6	C95914	67	STDRMR2340C0-6	C88811	59	TR315X5X6MM	C26494	29
DGRDR2340-4	C72944	67	STDRMR2380C0-4	C11985	59	TR335X5X6MM	C27904	29
DGRDR2340-6	C93784	67	STDRMR2380C0-6	C54115	59	TR600X5X6MM	C89350	29
DGRDR2380-4	C10495	67	STDRMR2500C0-4	C72507	59			
DGRDR2380-6	C53020	67	STDRMR2500C0-6	C45128	59			
DGRDR2500-4	C87771	67	TEKLRBT75X335X6MM	C96274	29			
DGRDR2500-6	C44308	67	TPRMR0980C0-4	C27354	60			
LM20CH4-CARB	C42897	12	TPRMR0980C0-6	C31427	60			
LM20CS4	C41016	12	TPRMR1250C0-4	C20256	60			
LM25CS45	C26619	9	TPRMR1250C0-6	C43574	60			
LM25CS45-CARB	C62908	9	TPRMR1285C0-4	C41022	60			
STDRMR0980C0-4	C85367	58	TPRMR1285C0-6	C15769	60			
STDRMR0980C0-6	C77209	58	TPRMR1406C0-4	C32825	60			
STDRMR1250C0-4	C87870	58	TPRMR1406C0-6	C22379	60			
STDRMR1250C0-6	C40706	58	TPRMR1563C0-4	C57905	60			
STDRMR1285C0-4	C59188	58	TPRMR1563C0-6	C80152	60			
STDRMR1285C0-6	C50598	58	TPRMR1590C0-4	C10752	60			
STDRMR1406C0-4	C88163	58	TPRMR1590C0-6	C69671	60			
STDRMR1406C0-6	C56849	58	TPRMR1610C0-4	C33113	60			
STDRMR1563C0-4	C13592	58	TPRMR1610C0-6	C37935	60			
STDRMR1563C0-6	C49695	58	TPRMR1719C0-4	C35875	60			

Navigating Our Website Is Easier Than Ever

Place an order with your distributor on corehog.com

Did you know that you can place a CoreHog order directly to your distributor from our website? After creating your corehog.com account, you're able to build and send "shopping carts" directly to your participating distributor to order.

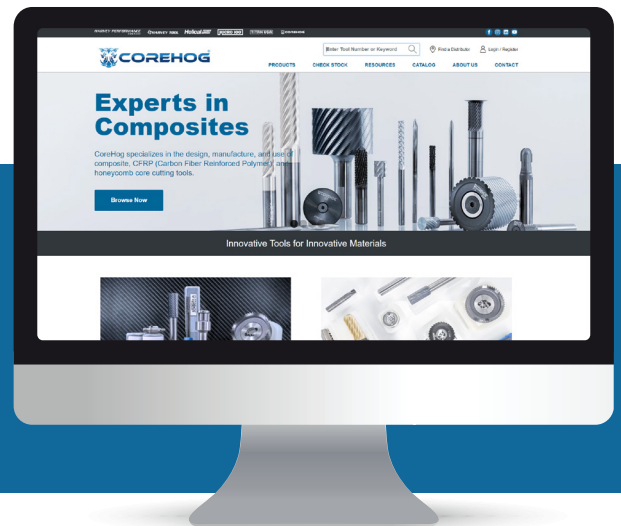

Shopping Cart

Once logged in, create your own personalized Shopping Carts of CoreHog tools you're most interested in, then send it directly to a participating distributor, or share it with a colleague or purchasing agent.



Expansive Stock Check

Check real-time availability of as many as 50 tools at once to simplify the order planning process and spend more time where it counts: at the spindle.



"Smart-Search" Feature

Simply and quickly search for a CoreHog tool, then receive results for its product page, as well as for every technical resource relevant to that tool, presented in one click to save you valuable time and money.



Product Table Filtering

Find the perfect CoreHog tool for your job quickly and easily by using new filtering functionality on each product table, sorting through an expansive and always growing product offering.

Get Connected With CoreHog

 Instagram @corehog

 TikTok @corehog

 Facebook @amscorehog

 LinkedIn @corehoginc

Join Our Email List

Scan the QR code to sign up for our email list! Our weekly email delivers valuable information about CoreHog products and technical resources directly to your inbox. Be the first to know of newly released tools to gain an immediate leg-up on the competition!

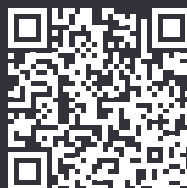

Find Technical Resources at corehog.com/resources

At CoreHog, we go the extra mile to ensure that your next CNC composite machining operation excels at every turn. Beyond the meticulous care and detail we put into each and every cutting tool we sell, we supply you with comprehensive and reliable speeds and feeds charts to allow you to achieve the most from your product. We also fully stock each of our products to guarantee that your cutting tool solutions reach your shop quicker. Further, our team of technical support representatives is available and always willing to help you with every detail of your application.

Speeds & Feeds

We've calculated Speeds & Feeds so you don't have to! Download our printer friendly PDFs for every applicable cutting tool to save valuable programming time.

Save Time & Money

Find all the running parameters you need, calculations account for multiple types of composite materials and the application that you are using to lower overall production costs.

Increase Tool Life

Get the most out of every tool you order from us with running parameters designed to decrease breakage and maximize tool life.

Minimize Damage

Speeds and feeds along with specialized geometries of the tool help minimize material failures such as delamination, tear out, and poor finish.

Educational Technical Resources



In The Loupe

Machinist Blog - In The Loupe
Your Source for Machining
Solutions including technical tips
& machining how-to's.



In The Loupe - TV

This new YouTube series delivers
answers to the cutting tool
questions all machinists ask. Follow
along as new episodes of In The
Loupe TV are added regularly.

Get in Touch With Us

For more information on CoreHog products and technical information visit www.corehog.com/resources, contact our support team at 833-584-3448, or email corehogsales@harveyperformance.com

Find Your Local Distributor at www.corehog.com or Call 833-584-3448

Our LARGEST Expansion Yet

CoreHog's new 2023 Product Catalog offers more than 450 new CNC cutting tools optimized for the machining of composite materials, **nearing doubling the size of our previous offering.**

Our latest innovations, including our new CFRP Drill, which features advanced geometry for unmatched CFRP drilling, provide you with maximized machining efficiency, accuracy, and consistency. Our improved offering also includes Potted Fastener Cutters, Compression Style CFRP Routers, Compression Style Laminate Kevlar® Cutters, and more.



CFRP Drills
pg 56

Potted Fastener
Cutters pg 32

CFRP Routers
Compression Style
pg 39

Miniature Drills
pg 55

Laminate Kevlar
Cutters Compression
Style pg 43

Miniature Diamond
Coated End Mills
Square & Ball
pg 46/47

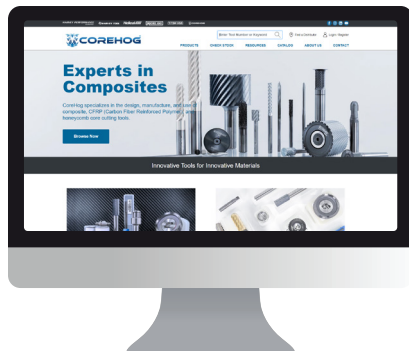

Resources to Simplify Your Cutting Tool Search

CoreHog's premium offering of composite-optimized cutting tools is backed by several website resources, each engineered to simplify your ordering process and enhance your overall CoreHog experience!



Find Your Local Authorized Distributor



Product Filtering to Quickly Sort Products



Build & Send Shopping Carts to a Distributor



Check Stock for Up to 50 Tools at a Time

HARVEY PERFORMANCE
 COMPANY

www.corehog.com | 833-584-3448
corehogsales@harveyperformance.com



Proudly Partnering with
 One Tree Planted
 Visit harveyperformance.com/trees