



INDUSTRIAL HEALTH & SAFETY
PRODUCT CATALOG



About Bullard



Bullard is a manufacturer of high-quality personal protective equipment and systems designed to help save lives around the world. Serving the industrial market for more than a century, Bullard manufactures head, face, and respiratory equipment that provide workers with high-quality, on-the-job protection they trust and rely on.

Market Leader

Bullard maintains its competitive edge through advanced engineering technologies, research and development, and value-added services to develop the most sophisticated, quality-driven, advanced products designed with worker safety in mind. From the time we invented the hard hat in 1919, our Company began a legacy of creating products that are uniquely designed with input from our customers.

Protection

The first Bullard hard hat was the beginning of the Company's prominence as an industry leader in head protection. Today, Bullard offers a full line of hard hats that have revolutionized the industry by offering workers superior performance, unmatched quality, durability, and added comfort. Worker safety is always paramount when designing Bullard products, so it was no surprise when Bullard became involved with the safety issues of workers constructing the Golden Gate Bridge in the 1930s. Bullard supplied the hard hats for the entire Golden Gate Bridge workforce and provided workers with the original supplied air respirator for blasting the steelwork.

Today, Bullard is a leader in respiratory protection equipment offering powered air-purifying respirators, airline respirators, pressure demand systems, supplied air filters and monitors, and a full range of breathing air pumps. Bullard respiratory products meet National Institute for Occupational Safety and Health (NIOSH) standards and provide high-quality protection to workers worldwide.

Innovation

Bullard continues to lead the industry with innovative products and accessories designed specifically to meet the needs of today's workforce. In 2012, Bullard launched the EVAHL Powered Air-Purifying Respirator offering 1,000 Assigned Protection Factor (APF) for Class I, Division 2, Hazardous Locations. The Company introduced the GenVX™ blast helmet in 2013, providing users with the industry's lightest, coolest, most comfortable, and most dependable helmet on the market. With Bullard products, you'll find the ultimate in functionality and durability. You'll also find extraordinary service and the most innovative designs.

Table of Contents



Terms and Conditions	1
Contact and Ordering	2
Information	2
Industrial Head and Face Protection Products	3
Regulations and Standards for Industrial Head Protection	4
Regulations and Standards for Face Protection.....	5
Advanced Head Protection.....	7
Advent® Helmet	7
Vector Helmet	9
Classic Series Hard Hats and Caps	14
Standard Series Hard Hats and Caps	17
Bump Caps	23
Industrial Head Protection Replacement Parts	26
Logo Shop.....	27
Reflective Striping	33
Face Protection.....	35
Body Temperature Management	43
The Turtle Club®.....	45
Respiratory Protection and Air Quality Products	47
Warnings, Regulations, Standards, and Protection Factors Research for Respirators	48
Powered Air-Purifying Respirators (PAPRs)	56
EVA Powered Air-Purifying Respirator.....	58
EVAHL Powered Air-Purifying Respirator	66
Guidance for PAPRs in Hazardous Locations.....	64
Supplied Air Respirators (SARs)	82
CC20 Series Airline Respirator	83
20LF Series	99
Loose-Fitting Facepiece	99
RT Series Airline Respirator	107
Blasting and Grinding Respirators.....	114
GenVX™ Series Airline Respirator.....	115
88VX Series Airline Respirator	125
GR50 Series Airline Respirator.....	139
Mask-Style Respirators	148
Spectrum® Series	148
FAMB2 Half-Mask Airline Respirator	167
Breathing Air Supply Hose	171
Personal Climate	178
Air Quality and Filtration.....	184
41 Series Airline Filters.....	184
Clean Air Box (CAB) Series Breathing Air Filtration.....	188
Free-Air® Pumps.....	195

Terms and Conditions

Customer Service Policy: This statement does not supersede the terms or conditions of sale that are printed on Bullard sales orders, acknowledgements, and packing slips. Instead, it is a guide to our customer service policies. Bullard reserves the right to change product specifications without notice.

Pricing: Orders must specify one destination and one shipping date. Prices are subject to change without notice. We attempt to advise our customers of price changes in advance but cannot guarantee to do so. Orders specifying future shipment are subject to prices effective at the time of shipment. Possession of a price list does not grant the right to distributor discounts.

Minimum Order: Minimum purchase order is \$100.00. Products from other Bullard price lists may be combined to meet minimum.

Terms: Standard terms net 30 days, F.O.B. shipping point.

Freight: Title to goods passes to the buyer upon delivery to the carrier at the Bullard dock. Orders of \$2,500 or more are shipped freight prepaid by Bullard within the continental U.S. via the carrier(s) of our choice. Products from other Bullard price lists may be combined to receive free freight. Orders specifying other means of shipment are shipped collect regardless of order value. To qualify for prepaid freight, orders must specify a single destination and shipping date.

Credit Policy: We reserve the right to assess a 1.5% service charge per month on overdue balances. Our credit department is authorized to hold shipments if past due balances are not paid.

Returned Goods: Refer to your Bullard distributor program for details.

Non-standard Orders: We welcome the opportunity to meet special requirements. However, special orders are accepted with the understanding that we may over-ship and bill accordingly by as much as 10% of the order, due to the special nature of the product.

Drop Shipments: In certain situations, drop shipments may be made to authorized distributor locations or other locations within a distributor's recognized territory. Please contact Bullard Customer Service for details.

Information Support Policy: Bullard provides distributors with catalogs, price lists, promotional literature, and other printed material. Generally, this information is provided to the distributor at no cost. However, Bullard reserves the right to charge a distributor when literature requests exceed reasonable levels based on the distributor's annual sales volume. All Bullard literature can also be downloaded from our website at no additional cost at www.bullard.com.



Contact and Ordering Information

Now there are more ways than ever to place an order with Bullard!

Fax

You can fax us any time – 24 hours a day. Faxed orders are processed promptly, and you will receive a Sales Order Confirmation back after the order has been entered into our system.

Toll-Free Fax Number: 1-800-877-6858

Local Fax Number: 1-859-234-6858

E-mail

E-mail your orders to orders@bullard.com.

EDI

Transaction sets are received as soon as they are sent, so the response turnaround is almost immediate. You can even use your own part numbers! Contact edi@bullard.com if you wish to become an EDI partner. **NOTE:** There is a \$100 purchase order minimum.

Mail

Send orders via mail to Bullard Customer Service if you have an account set up with us. The mailing address for Bullard is below.

Contact

In Person

Your Bullard Regional Sales Manager will visit your facility and listen to your needs. They can help you decide on the combination of safety products that will best serve you and provide a quote, technical information, product availability, and ordering information.

Call us

Call us anytime between 8:00 a.m. and 6:00 p.m. EST, Monday through Friday, and one of our experienced Customer Service Representatives will assist you with preparing your order. Special order requirements? Just contact a Bullard Customer Service Representative to discuss the options. We do not take orders over the phone; you must e-mail or fax a copy of the purchase order.

Americas:

Bullard

1898 Safety Way
Cynthiana, KY 41031-9303
Toll free within USA:
877-BULLARD (285-5273)
Tel: +1-859-234-6616
Fax: +1-859-234-8987

Europe:

Bullard GmbH

Lilienthalstrasse 12
53424 Remagen
Germany
Tel: +49-2642 999980
Fax: +49-2642 9999829

Asia-Pacific:

Bullard Asia Pacific Pte. Ltd.

LHK Building
701, Sims Drive, #04-03
Singapore 387383
Tel: +65-6745-0556
Fax: +65-6745-5176



Don't Forget to Visit Us Online!

Check out our website and follow us on Facebook and YouTube.

www.bullard.com

www.facebook.com/BullardCompany

www.facebook.com/BullardER

www.facebook.com/BullardIHS

www.youtube.com/BullardTV



Industrial Head and Face Protection Products

877-BULLARD (285-5273) • International calls +1-859-234-6616

Regulations and Standards for Industrial Head Protection

Types of Hard Hats

Type I/1 – Conventional hard hats that are designed to reduce the force of impact to the top of the head, neck, and spine.

Type II/2 – Designs that offer additional impact protection to the front, sides, and back, as well as the top of the head.

Bullard Model	Standard	Type and Class
 C30	ANSI/ISEA Z89.1-2009 CSA Z94.1-2005	Type I, Class E & G,  , LT, HV Type 1, Class E & G
 C33	ANSI/ISEA Z89.1-2009 CSA Z94.1-2005	Type I, Class E & G,  , LT, HV Type 1, Class E & G
 C34	ANSI/ISEA Z89.1-2009	Type I, Class E & G,  , LT, HV
 911C	ANSI/ISEA Z89.1-2009	Type I, Class E & G,  , LT, HV
 911H	ANSI/ISEA Z89.1-2009	Type I, Class E & G,  , LT, HV
 S51	ANSI/ISEA Z89.1-2009 CSA Z94.1-2005 EN397-2012	Type I, Class E & G,  , LT, HV Type 1, Class E & G Type 1, Class E & G, LT
 S61	ANSI/ISEA Z89.1-2009	Type I, Class E & G,  , LT, HV
 S62	ANSI/ISEA Z89.1-2009	Type I, Class C,  , LT, HV
 S71	ANSI/ISEA Z89.1-2009	Type I, Class E & G,  , LT, HV
 Advent®	ANSI/ISEA Z89.1-2009	Type II, Class E & G, LT
 Vector	ANSI/ISEA Z89.1-2009 CSA Z94.1-2005	Type II, Class E & G, LT, HV Type 2, Class E & G

CAN/CSA Z94.1-2005 - www.csa.ca

National Standard for Canada

This is the fifth edition of CSA Z94.1, Industrial Protective Headwear - Performance, selection, care and use. It supersedes the previous editions published in 1992, 1977, and 1966 under the title Industrial Protective Headwear. It also supersedes the Preliminary Standard, published in 1965, and replaces the protective headwear requirements specified in CSA Z94-1948, Code for Head and Eye Protection. Bullard's S51, C30, and C33 all meet CSA Z94.1-2005, Type 1, Class E & G; Bullard's Vector meets CSA Z94.1-2005, Type 2, Class E & G.

European Standard for Industrial Safety Helmets EN 397:2012

EN 397:2012 certifies that safety helmets are designed to offer protection from lateral impact or top impact. It supersedes EN 397:1995. This European Standard specifies physical and performance requirements, methods of test, and marking requirements for industrial safety helmets. The mandatory requirements of EN 397 apply to helmets for general use in industry in the European Union as mandated by 89/686/EEC for personal protective equipment. Additional optional performance requirements are included to apply only where specifically claimed by the helmet manufacturer. Industrial safety helmets (also known as headgear) are intended primarily to provide protection to the wearer against falling objects to avoid brain injury and skull fracture. EN 397:2012 is written by Technical Committee CEN/TC 158 on "Head Protection." Countries in Europe are expected to adopt it as a national standard, either by publication of an identical text or by endorsement.

Classes of Hard Hats

Class E (electrical) hats are tested to withstand 20,000 volts.

Class G (general) hats are tested at 2,200 volts.

Class C (conductive) hats provide no electrical protection.

OSHA 29 CFR 1910.135 - www.osha.gov

This standard requires head protection if any aspect of the work environment presents a risk of head injury.

ANSI/ISEA Z89.1-2009 - www.ansi.org or www.safetyequipment.org

National Standard for U.S.

This standard provides performance and testing requirements for industrial helmets (commonly known as hard hats). It establishes the types and classes of protective helmets, depending on the type of hazard encountered. It includes specifications for helmets designed to offer protection from lateral impact (Type II), or top-only impact (Type I), giving employers and users the flexibility to specify the helmet that best meets the needs of their specific workplace.

This standard outlines requirements for industrial head protection relating to:

1. Impact Protection
2. Penetration Protection
3. Electrical Insulation Protection

Three non-mandatory tests were added to this newest revision of the standard (ANSI/ISEA Z89.1-2009 is the revision of the previous ANSI Z89.1-2003). Manufacturers who want to claim any of these features can (1) test their helmets according to the new procedures, and (2) label their products appropriately:

1. Reverse Donning, []

All of Bullard's Type I hard hats are marked with  to indicate that they meet the new requirements for the non-mandatory reverse donning. In order to wear your Bullard Hard Hat backwards, the user must first reverse his/her suspension, so that the nape strap is in the rear and brow pad in the front.

2. Lower Temperature, [LT]

All Bullard Hard Hats are tested to the requirements for the non-mandatory lower temperature (-30° C or -22° F) and marked with "LT." The traditional low temperature test for a helmet is -18° C or 0° F; the LT testing is even more rigorous.

3. High-Visibility, [HV]

Bullard's Hi-Viz Yellow meets the non-mandatory requirements for high-visibility, including special tests for Chromaticity and Luminescence for added visibility.

Type I/1 warning label

▲ WARNING

Hard hats are designed to provide limited protection to the head by reducing the force of falling objects striking the top of the hard hat shell. While limited protection is provided in other parts of the shell, this hard hat was not designed to provide front, side or rear impact protection. Avoid contact with electrical wires. **NEVER ALTER OR MODIFY THE SHELL OR SUSPENSION SYSTEM. ALWAYS USE BULLARD REPLACEMENT PARTS.**

Inspect your hard hat shell and suspension regularly. Check for cracks, frayed straps and any signs of damage before each use. Replace the hard hat immediately if you notice any signs of wear, damage, abuse or environmental degradation. If the hard hat has sustained a forcible blow (impact), dispose of it immediately, even if damage is not visible. Failure to follow these warnings could result in death or serious injury.

Regulations and Standards for Face Protection

ANSI/ISEA Z87.1-2010 – Standard for Occupational and Educational Personal Eye and Face Protection

Bullard's industrial faceshields are all tested to ANSI/ISEA Z87.1-2010, the standard that sets forth criteria for the general requirements, testing, permanent marking, selection, care, and use of protectors to minimize the occurrence and severity or prevention of injuries from such hazards as impact, non-ionizing radiation, and chemical exposures in occupational and educational environments including, but not limited to, machinery operations, material welding and cutting, chemical handling, and assembly operations. The standard provides the minimum requirements for protectors including selection, use, and maintenance of these protectors as devices to minimize or prevent eye and face injuries. The standard has tests for Optical Requirements, Physical Requirements, Lens Thickness (for non-impact rated faceshields), and Marking Requirements.

In April of 2010, the American National Standards Institute (ANSI) along with the Industrial Safety Equipment Association (ISEA) approved the 2010 version of Z87.1 Standard for Occupational and Educational Personal Eye and Face Protection Devices, ANSI/ISEA Z87.1-2010. The updated standard is organized by hazard type in order to help end users to select their eye and face protection for the specific hazard they encounter. As such, the standard is organized by hazard type (such as impact, splash/droplet, optical radiation, dust, fine dust, and mist).

In Z87.1-2003, protective products are marked as providing "Non-impact" (formerly Basic) or "Impact" (formerly High-Impact) protection. In the 2010 standard, the products are either non-impact or impact protectors. Products marked as impact protectors must pass all high-impact testing requirements and will be marked as "Z87+". Non-impact protectors are those that do not pass all high-impact testing requirements and are therefore marked only with "Z87" (no "+" sign). All Bullard brackets will be marked as Z87+ as well, to show that they can accommodate Impact Protectors. Although the new standard eliminates the distinction between Primary and Secondary Eye protection (faceshields were previously considered secondary protection and needed safety glasses under the visors), to ensure maximum protection, Bullard continues to recommend that Z87+ impact eye protection always be worn under faceshields.

Bullard visors conform to ANSI/ISEA Z87.1-2010 standard when used in combination with Bullard approved headgear or faceshield brackets under the following classification by model number:

Bullard Visors

Bullard Model	Material	Classification
640	Acetate	Z87 Non-impact Protector
640G	Acetate	Z87 Non-impact Protector
640PW3	Polycarbonate	Z87+ Impact Protector
640PW5	Polycarbonate	Z87+ Impact Protector
840M	Acetate	Z87 Non-impact Protector
840MH	Acetate	Z87 Non-impact Protector
840MX2	Acetate	Z87 Non-impact Protector
840MG	Acetate	Z87 Non-impact Protector
860H	Acetate	Z87 Non-impact Protector
CS40	Acetate	Z87 Non-impact Protector
1040	Acetate	Z87 Non-impact Protector
840ME	Polyester	Z87 Non-impact Protector
E840ME	Polyester	Z87 Non-impact Protector
680P	Polycarbonate	Z87+ Impact Protector
840P	Polycarbonate	Z87+ Impact Protector
840PW3	Polycarbonate	Z87+ Impact Protector
840PW5	Polycarbonate	Z87+ Impact Protector
840PX2	Polycarbonate	Z87+ Impact Protector
840PX2W3	Polycarbonate	Z87+ Impact Protector
840PX2W5	Polycarbonate	Z87+ Impact Protector
860P	Polycarbonate	Z87+ Impact Protector
880P	Polycarbonate	Z87+ Impact Protector
WS60PM	Polycarbonate	Z87+ Impact Protector
6S24	Mesh Screen	Z87 S Special Purpose
8S24	Mesh Screen	Z87 S Special Purpose
680T	Tritan	Z87+ Impact Protector
840T	Tritan	Z87+ Impact Protector
840TX2	Tritan	Z87+ Impact Protector
860T	Tritan	Z87+ Impact Protector
880T	Tritan	Z87+ Impact Protector
WS60TM	Tritan	Z87+ Impact Protector

Regulations and Standards for Face Protection

Bullard Brackets

Model	Description	Material	Standard	Fits Hard Hat Models									No Head Protection	
				Cap Style				Full-Brim		Type II		Bump Cap		
				C30 911H	S61	S62	S51	C33/C34 911H	S71	Advent®	Vector			
300B	Dielectric, band mounting	Nylon	Z87/Z87+	x	x	x	x				x	x	x	
300BW	Dielectric, band mounting with neoprene gasket	Nylon	Z87/Z87+	x	x	x	x				x	x	x	
400	Dielectric, slot mounting	Nylon	Z87/Z87+	x	x	x	x							
400W	Dielectric, slot mounting with neoprene gasket	Nylon	Z87/Z87+	x	x	x	x							
312B	Dielectric, band mounting	Nylon	Z87/Z87+					x	x					
100G	Gold Line, band mounting	Aluminum	Z87/Z87+	x	x	x	x						x	
110G	Gold Line, band mounting for reverse orientation	Aluminum	Z87/Z87+	x	x	x	x							
112G	Gold Line, band mounting	Aluminum	Z87/Z87+					x	x					
500M	Gold Line, slot mounting	Aluminum	Z87/Z87+	x										
SENTINEL1	Headgear	ABS	Z87/Z87+											x
SENTINEL2	Headgear with chin protector	ABS	Z87/Z87+											x
ADFB	Accessory blades and hardware	ABS	Z87/Z87+								x	x		



Advanced Head Protection Advent® Helmet

The Advent® Helmet. Designed specifically for emergency response services.

The Advent® helmet offers paramedics, emergency medical technicians, industrial hazard response teams, and search and rescue personnel a revolutionary new concept in head protection. Available in two models, Advent® offers a variety of special benefits.

Highly Protective

Advent® offers top, front, side, and rear impact and penetration protection. This level of head protection is essential for emergency response professionals who are involved in everything from vehicle extrication to rope rescue. Advent® meets or exceeds all requirements of ANSI/ISEA Z89.1-2009, Type II, Class E & G.

Comfortable

At just over 25 ounces (709g), Advent® is half the weight of conventional firefighter helmets and is the same weight as many climbing helmets. Its compact design with no rear brim improves freedom of movement both in and out of emergency vehicles and confined spaces. A crown pad and a soft, replaceable, foam-backed vinyl brow pad provide extra comfort.

Easy Adjustment

The Advent® adjustable Sure-Lock® ratchet suspension (ADRTSL) makes it easy to size instantly.

Economical

Advent® is affordable. In fact, it's less than half the price of conventional fire helmets.

Adaptable

Advent® can be equipped with a variety of accessories, including faceshields, ear/neck protectors, and hearing protectors.

Easy to Customize

Advent® is designed as part of the professional's standard uniform. Both models are available in five colors and may be customized with pad printed logos, decals, and reflective stripes. Logos may be printed using up to six colors in as many as eight different locations.



Available Colors



Yellow
(YL)



Orange
(OR)



Red
(RD)



Blue
(BL)



White
(WH)

Advanced Head Protection - Advent® Helmet

Revolutionary Construction, Advanced Levels of Protection.

1. Tough Thermoplastic Outer Shell: Provides superior impact and penetration protection over a wide range of temperatures.
2. ABS and Foam Core Inner Shell: Protects by distributing forces of impact over a wide area.
3. 2- or 3-point Chinstrap with Quick-Release Buckle: Provides safety, versatility, and security.
4. Sure-Lock® Ratchet Headband: Offers quick adjustment and great fit.
5. 8-point Crown Strap System: Gives stability and comfort to the end-user.
6. Decals and Pad Printing: Customize your helmet with a Bullard decal on the front or sides. Pad printing is available in 8 locations.
7. Shell available in 5 colors.
8. Expanded Polystyrene Foam Core: Reduces the possibility of serious head injury by helping to absorb forces of impact.

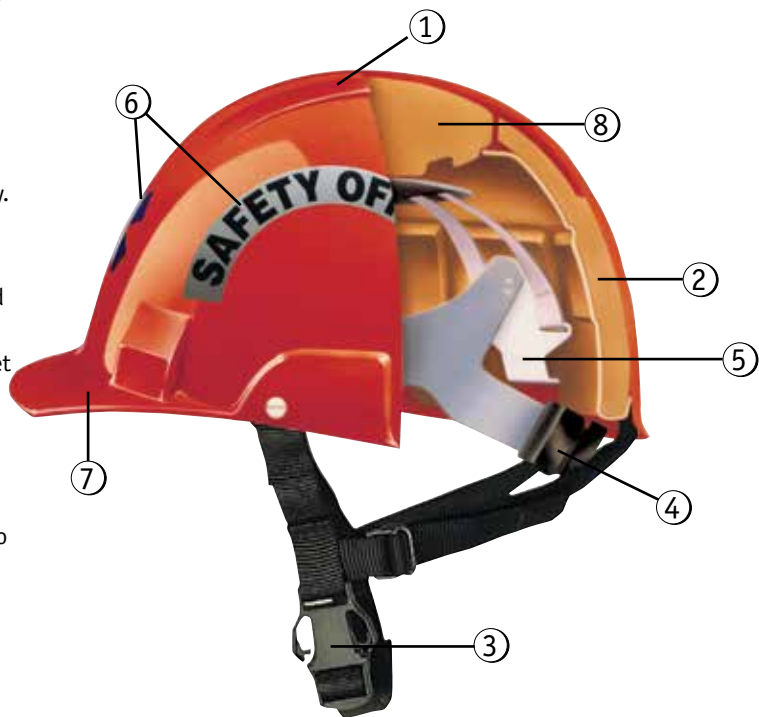

The Bullard three-rib design is a registered trademark of Bullard.



A1S

Advent® Helmet with 2-point Chinstrap

- Polycarbonate alloy shell
- Meets or exceeds ANSI/ISEA Z89.1-2009, Type II, Class E & G requirements
- ABS and EPS foam core impact liner
- Foam-backed vinyl crown pad and replacable brow pad
- ABS inner shell
- 8-point Sure-Lock® ratchet suspension (ADRTSL)
- 2-point chinstrap with dielectric quick-release buckle (A110)
- Case quantity: 10; minimum order: 1



A1RDS

A2S

Advent® Helmet with 3-point Cradle Chinstrap

- Same as Model A1 above with
- 3-point cradle chinstrap
- Dielectric quick-release buckle
- Case quantity: 10; minimum order: 1



A2BLS

Additional Accessories

Customization • Shell color chart • Part number

p. 11-13

p. 27-32

Advanced Head Protection Vector Helmet

The Vector Helmet. Designed to meet ANSI/ISEA and CSA Type II/2 Standards.

The Bullard Vector helmet provides impact protection for the top, front, back, and side of the head. Vector helmets are lightweight, comfortable, affordably priced, and designed to accommodate numerous accessories. In addition to the advanced features, the helmet is easy to customize with company logos, slogans, and reflective markings.

Protective

Vector helmets use a full inner shock liner to absorb impacts from the top, front, back, and side. The shock liner is carefully engineered to provide advanced protection with minimal weight. Combined with its heavy-duty polyethylene shell and optional self-sizing pinlock suspension or Flex-Gear® ratchet suspension, Vector offers advanced protection at a competitive price. A two-point chinstrap and heavy-duty polycarbonate faceshield are available as options.

Comfortable

Vector helmets offer lateral and top impact protection with only a slight weight addition over conventional hard hats. Either the self-sizing pinlock VT600 suspension or VTRT600 Flex-Gear® ratchet suspension ensures a secure and comfortable fit for virtually all head sizes and shapes. The standard Sportek brow pad is the most absorbent and comfortable brow pad available.

Economical

Vector helmets offer advanced head protection and comfort at an affordable price. The lightweight Vector helmets are compliant with ANSI/ISEA Z89.1-2009, Type II, Class E & G, and CSA Z94.1-2005, Type 2, Class E & G requirements. The Sportek brow pad, comfortable suspension, built-in goggle strap retaining slots, and Bullard's unsurpassed reputation for quality make Vector helmets a superior value in industrial head protection.

Easy to Customize

Vector helmets are available in eight standard shell colors and can be decorated with pad printed logos, decals, and reflective stripes. Logos may be printed using up to six colors in as many as eight different locations.



Available Colors



Advanced Head Protection - Vector Helmet

Advanced Levels of Protection

- 1. Outer Shell of Polyethylene**
Lightweight design for maximum comfort.
- 2. Expanded Polystyrene Foam Core**
Reduces the possibility of serious head injury by helping to absorb the forces of impact.
- 3. Four-point Suspension System**
Straps are angled to fit the head for superior balance and comfort.
- 4. Ventilation Channels**
Help keep wearer cooler.
- 5. Sizing Mechanism**
Choose from either the Flex-Gear® ratchet or self-sizing pinlock suspension.

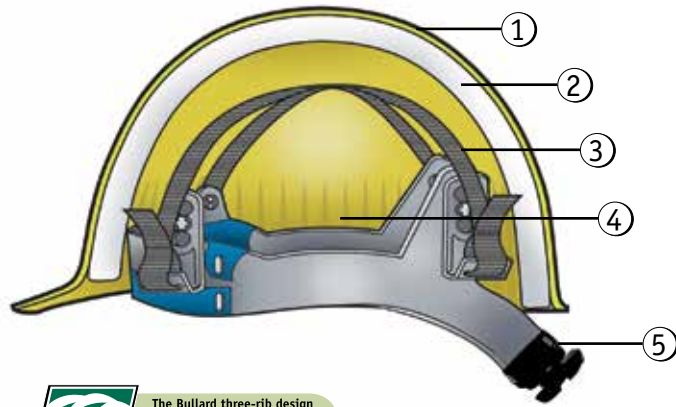

The Bullard three-rib design is a registered trademark of Bullard.



VTP

Helmet with Self-sizing pinlock suspension

- High-density polyethylene shell
- Meets or exceeds ANSI/ISEA Z89.1-2009, Type II, Class E & G and CSA Z94.1-2005, Type 2, Class E & G requirements
- EPS foam impact liner
- 4-point self-sizing pinlock suspension (VT600)
- Case quantity: 10; minimum order: 10



VTR

Helmet with Flex-Gear® Ratchet Suspension

- Same as Model Vector above with
- 4-point Flex-Gear® ratchet suspension (VTRT600)
 - Case quantity: 10; minimum order: 10



Additional Accessories

p. 11-13

Customization • Shell color chart • Part number

p. 27-32

Advanced Head Protection

Advent® Replacement Parts and Accessories

-
- ADRTSL** Suspension for Advent®
- 8-point Sure-Lock® ratchet suspension
 - Foam-backed vinyl brow and crown pad (A101)



-
- A101** Brow Pad
- Foam-backed ventilated vinyl
 - For ADRTSL-Advent® suspension



VECTOR Replacement Parts and Accessories

-
- VT600** Suspension for Vector
- 4-point self-sizing pinlock suspension
 - Sportek brow pad (TT3)
 - Three vertical adjustments in front and rear
 - Includes built-in goggle strap retaining slots



-
- VTRT600** Suspension for Vector
- 4-point Flex-Gear® ratchet suspension
 - Sportek brow pad (TT3)
 - Three vertical adjustments in front and rear
 - Includes built-in goggle strap retaining slots



-
- VTS** Foam Liner for Vector
- Expanded polystyrene (EPS) foam liner replacement



-
- TT3** Brow Pad
- Sportek replacement brow pad
 - For 4-point VT600, VTRT600 suspensions



Advanced Head Protection

Advent® and Vector Replacement Parts

- A110** Chinstrap for Advent® or Vector
- 2-point nylon chinstrap
 - Quick-release buckle



- ADFB** Accessory Blades
- For mounting 4" or 6" faceshield on Advent® or Vector
 - Includes blades and hardware
 - Faceshield must be purchased separately (R325 or R330)



- R325** Faceshield
- 6" faceshield
 - Optically correct polycarbonate faceshield
 - ADFB blades are required for assembly - sold separately



- R330** Faceshield
- 4" faceshield
 - Optically correct polycarbonate faceshield
 - ADFB blades are required for assembly - sold separately



- R160** Ratchet Cover
- Leather ratchet cover
 - For all Bullard ratchet suspensions



Advanced Head Protection

Customization for Advent® and Vector

OR145 3" (7.6 cm) Star of Life decal



Crescent Lettering Approx. 7" x 3" (1" wide)



OR308
Emergency Medical Technician



OR309
Safety Officer



OR310
Paramedic



OR311
Rescue



OR315
Rescate



OR316
Paramedico



OR320
Ambulance



Classic Series Hard Hats and Caps

The Classic. The most comfortable hard hats and caps in the industry.

Featuring a wider profile than most hard hats, Classic caps and hats offer increased protection from rain, snow, dust, and harmful ultraviolet (UV) rays. With the Classic, you'll find a balanced fit with a comfortable six-point suspension.

Meets Safety Requirements

Models C30, C33, C34, 911C, and 911H conform to all OSHA and ANSI/ISEA Z89.1-2009, Type I, Class E & G requirements, including impact, penetration, and electrical. Models C30 and C33 also conform to CSA Z94.1-2005, Type 1, Class E & G requirements.

Decoration

No other manufacturer offers more decorating flexibility and capability than Bullard. Bullard Logo Shop uses state-of-the-art technology to imprint your company logo or safety slogan in up to six colors in virtually any lateral position on the shell. No other manufacturer offers a decoration program that is as easy, fast, or reliable. Configure your Bullard hard hat on www.BuildYourBullard.com

Worker visibility can be increased with Scotchlite® reflective stripes in a multitude of colors. Bullard offers a variety of shell colors and can match other colors for companies requiring specific shades.

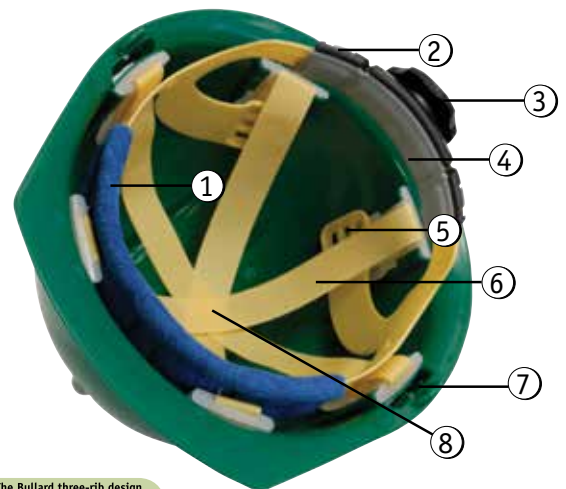

 The Bullard three-rib design is a registered trademark of Bullard.

Available Colors

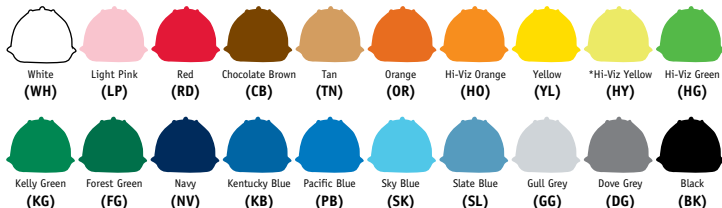

*Meets ANSI/ISEA Z89.1-2009 non-mandatory performance visibility requirements

1. Pillowed Brow Pad in Vinyl, Cotton, or Polartec
2. Flex-Gear® Ratchet System
3. Ratchet Sizing Knob
4. Nape Cushion with Flex Points
5. Easy to Adjust Vertical Height Settings
6. Seamless 1" Nylon Crown Straps
7. Accessory Slots for Attachments
8. Six-point Balanced Suspension

Classic Series Hard Hats and Caps

C30 Model

- 30P** Classic Series Cap
- High-density polyethylene shell
 - Full profile, wide brim
 - Accessory slots for attachments
 - 6-point self-sizing pinlock suspension with large, absorbent cotton brow pad (RS6PC)
 - Replacement brow pads available (RBPCOTTON, RBPVINYL, RBPCOOL)
 - Meets or exceeds ANSI/ISEA Z89.1-2009, Type I, Class E & G and CSA Z94.1-2005, Type 1, Class E & G requirements
 - Case quantity: 20; minimum order: 20



- 30R** Classic Series Cap
- Same as Model C30P above with
- 6-point Flex-Gear® ratchet suspension with large, absorbent cotton brow pad (RS6RC)
 - Replacement brow pads available (RBPCOTTON, RBPVINYL, RBPCOOL)
 - Case quantity: 20; minimum order: 20

C33 Model

- 33P** Classic Series Hat
- High-density polyethylene shell
 - Full profile, full-brim
 - 6-point self-sizing pinlock suspension with large, absorbent cotton brow pad (RS6PC)
 - Replacement brow pads available (RBPCOTTON, RBPVINYL, RBPCOOL)
 - Meets or exceeds ANSI/ISEA Z89.1-2009, Type I, Class E & G requirements and CSA Z94.1-2005, Type 1, Class E & G requirements
 - Case quantity: 10; minimum order: 20



- 33R** Classic Series Hat
- Same as Model C33P above with
- 6-point Flex-Gear® ratchet suspension with large, absorbent cotton brow pad (RS6RC)
 - Replacement brow pads available (RBPCOTTON, RBPVINYL, RBPCOOL)
 - Case quantity: 10; minimum order: 20

C34 Model

- 34P** Extra-Large Classic Series Hat
- High-density polyethylene shell
 - Extra-large, full-brim
 - 12% more interior space than the C33 model
 - 6-point self-sizing pinlock suspension with large, absorbent cotton brow pad (RS6PC)
 - Replacement brow pads available (RBPCOTTON, RBPVINYL, RBPCOOL)
 - Meets or exceeds ANSI/ISEA Z89.1-2009, Type I, Class E & G requirements
 - Case quantity: 10; minimum order: 20



- 34R** Extra-Large Classic Series Hat
- Same as Model C34P above with
- 6-point Flex-Gear® ratchet suspension with large, absorbent cotton brow pad (RS6RC)
 - Replacement brow pads available (RBPCOTTON, RBPVINYL, RBPCOOL)
 - Case quantity: 10; minimum order: 20

Replacement Parts • Accessories

p. 19-22

Customization • Shell color chart • Part number

p. 27-34

Faceshield brackets • Visors

p. 35-42



Classic Series High Heat Hard Hats and Caps

To meet the demands of high heat environments, Bullard produces hats and caps in technologically advanced thermoplastic materials. Constructed from the same materials as our rugged Wildland firefighter helmets, Bullard Models 911C and 911H are ideal for utilities, welding, foundries, and steel mills. Select either the FRS6PC self-sizing pinlock suspension or the FRS6RC Sure-Lock® non-slip ratchet suspension. Both suspensions feature 1" (2.54 cm) wide seamless nylon straps and a cotton removable brow pad for superior absorbency and comfort. Vertical adjustment hanger keys on the front and rear positions of the headband form the basis for a truly customized fit. Hard hats and caps can be printed with company logos or safety slogans in up to six colors in virtually any lateral position on the shell. Worker visibility can be increased with Scotchlite® reflective stripes or small reflective stripes in a variety of colors and a broad range of reflectivity.

Models 911C and 911H Helmets meet or exceed ANSI/ISEA Z89.1-2009, Type I, Class E & G requirements.

911 Series

- 9CP** High Heat Cap
- High-heat resistant thermoplastic outer shell
 - 6-point self-sizing pinlock suspension (FRS6PC)
 - Cotton brow pad (RBPCOTTON)
 - Meets or exceeds ANSI/ISEA Z89.1-2009, Type I, Class E & G requirements
 - Case quantity: 20; minimum order: 10



9CYLR
911 Series Cap with Sure-Lock® Ratchet Suspension

- 9CR** High Heat Cap
- Same as Model 911C above with
- 6-point Sure-Lock® ratchet suspension (FRS6RC)
 - Cotton brow pad (RBPCOTTON)
 - Case quantity: 20; minimum order: 10

- 9HP** High Heat Hat
- High-heat resistant thermoplastic outer shell
 - Full-brim model
 - 6-point self-sizing pinlock suspension (FRS6PC)
 - Cotton brow pad (RBPCOTTON)
 - Meets or exceeds ANSI/ISEA Z89.1-2009, Type I, Class E & G requirements
 - Case quantity: 10; minimum order: 10



9HBLR
911 Series Cap with Ratchet Suspension

- 9HR** High Heat Hat
- Same as Model 911H above with
- 6-point Sure-Lock ratchet suspension (FRS6RC)
 - Cotton brow pad (RBPCOTTON)
 - Case quantity: 10; minimum order: 10

Available Colors

The High Heat Hard Hats and Caps are available in a select number of colors.



Replacement Parts • Accessories	p. 19-22
Customization • Shell color chart • Part number	p. 27-34
Faceshield brackets • Visors	p. 35-42

Standard Series Hard Hats and Caps

The Standard. Takes style and versatility to a new level.

The low profile shell design of the Standard cap combines a perfect fit with a look workers prefer. The sleek, trim shell profile is the most stylish in the industry.

Meets Safety Requirements

Bullard Models S51, S61, and S71 conform to all ANSI/ISEA Z89.1-2009, Type I, Class E & G requirements, including impact, penetration, and electrical insulation. Bullard Model S62 (vented) conforms to all ANSI/ISEA Z89.1-2009, Type I, Class C requirements, including impact and penetration. Model S51 conforms not only to ANSI/ISEA Z89.1-2009, Type I, Class E & G requirements but also to CSA Z94.1-2005, Type 1, Class E & G and EN397: 2012, Type 1, Class E & G requirements.

Decoration

Bullard Logo Shop uses state-of-the-art technology to imprint your company's logo or safety slogan. Whether the design is one color or six, it can be reproduced accurately, quickly, and inexpensively. No other manufacturer offers a decoration program that is as easy, fast, or reliable. Configure your Bullard hard hat on www.BuildYourBullard.com

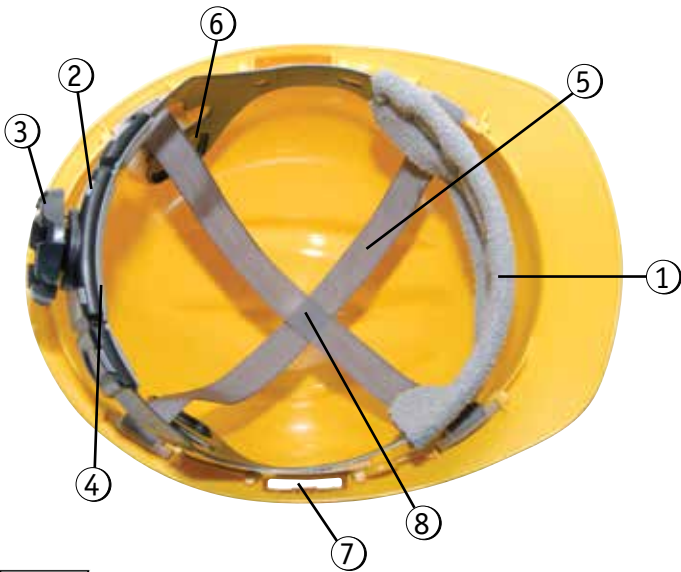

1. Pillowed Brow Pad in Vinyl, Cotton, Polyester, or Polartec
2. Flex-Gear® Ratchet System
3. Ratchet Sizing Knob
4. Nape Cushion with Flex Points
5. Seamless 3/4" Nylon Crown Straps
6. Easy to Adjust Vertical Height Settings
7. Accessory Slots for Attachments
8. Four-point Balanced Suspension



Available Colors



*Meets ANSI/ISEA Z89.1-2009 non-mandatory performance visibility requirements

Standard Series Hard Hats and Caps

Model S51

- 51P** Standard Series Cap
- High-density, polyethylene shell with flat front, low-profile design
 - Accessory slots for attachments
 - Rain trough brim
 - 4-point self-sizing pinlock suspension with poly (RS4PP) brow pad
 - Replacement brow pads available (RBPCOTTON, RBPVINYL, RBPCOOL)
 - Meets or exceeds ANSI/ISEA Z89.1-2009, Type I, Class E & G and CSA Z94.1-2005, Type 1, Class E & G requirements, & EN397:2012
 - Case quantity: 20; minimum order: 20



- 51R** Standard Series Cap
Same as Model S51P above with
- 4-point Flex-Gear® ratchet suspension with poly (RS4RP) brow pad

Model S61

- 61P** Standard Series Cap
- High-density, polyethylene shell with rounded front, low-profile design
 - Accessory slots for attachments
 - 4-point self-sizing pinlock suspension with large, absorbent cotton (RS4PC) brow pad
 - Replacement brow pads available (RBPCOTTON, RBPVINYL, RBPCOOL)
 - Meets or exceeds ANSI/ISEA Z89.1-2009, Type I, Class E & G requirements
 - Case quantity: 20; minimum order: 20



- 61R** Standard Series Cap
Same as Model S61P above with
- 4-point Flex-Gear® ratchet suspension with large, absorbent cotton (RS4RC) brow pad

Model S62

- 62P** Standard Series Cap
- Vented shell
 - High-density, polyethylene shell with rounded front, low-profile design
 - Accessory slots for attachments
 - 4-point self-sizing pinlock suspension with large, absorbent cotton (RS4PC) brow pad
 - Replacement brow pads available (RBPCOTTON, RBPVINYL, RBPCOOL)
 - Meets or exceeds ANSI/ISEA Z89.1-2009, Type I, Class C requirements
 - Case quantity: 20; minimum order: 20

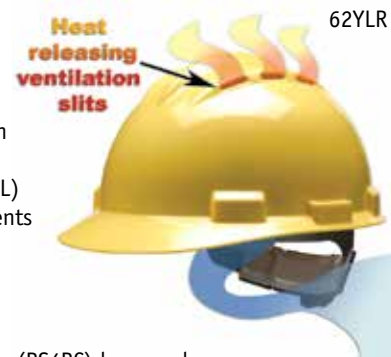

- 62R** Standard Series Cap
Same as Model S62P above with
- 4-point Flex-Gear® ratchet suspension with large, absorbent cotton (RS4RC) brow pad

Model S71

- 71P** Standard Series Hat
- High-density, polyethylene shell with a full brim, low-profile design
 - 4-point self-sizing pinlock suspension with large, absorbent cotton (RS4PC) brow pad
 - Replacement brow pads available (RBPCOTTON, RBPVINYL, RBPCOOL)
 - Meets or exceeds ANSI/ISEA Z89.1-2009, Type I, Class E & G requirements
 - Case quantity: 10; minimum order: 20



- 71R** Standard Series Hat
Same as Model S71P above with
- 4-point Flex-Gear® ratchet suspension with large, absorbent cotton (RS4RC) brow pad

Replacement Parts • Accessories

p. 19-22

Customization • Shell color chart • Part number

p. 27-34

Faceshield brackets • Visors

p. 35-42



Classic and Standard Series Hard Hats and Caps

Classic Series Replacement Parts and Accessories

Replacement Suspensions for Models C30, C33, and C34

RS6PC

- 6-point self-sizing pinlock suspension
- Large, absorbent cotton brow pad
- Replacement brow pads available (RBPCOTTON, RBPVINYL, RBPCOOL)
- Vertical height adjustments (two front, three rear)
- For Models C30, C33, and C34



RS6RC

- 6-point Flex-Gear® ratchet suspension
- Large, absorbent cotton brow pad
- Replacement brow pads available (RBPCOTTON, RBPVINYL, RBPCOOL)
- Flex-points and nape cushion
- Large, easy-to-turn ratchet knob
- Vertical height adjustments (two front, three rear)
- For Models C30, C33, and C34



FRS6PC

- Same features as RS6PC
- For Models 911C and 911H



Replacement Suspensions 911 Series Hard Hats

FRS6RC

- Same features as RS6RC, but with Sure-Lock® Ratchet
- For Models 911C and 911H



Q: How do I determine the model number of my hard hat?

A: It's easy. Look under the brim of the hat or cap; the model number is molded right into the brim.

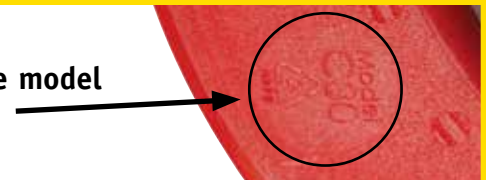

Classic and Standard Series Hard Hats and Caps

Standard Series Replacement Parts and Accessories

Replacement Suspensions for Models S51, S61, S62, and S71

RS4PC

4-pt. Suspension

- 4-point self-sizing pinlock suspension
- Large absorbent cotton brow pad
- Replacement brow pads available (RBPCOTTON, RBPVINYL, RBPCOOL)
- Vertical height adjustments (two front, two rear)
- For Models S51, S61, S62, and S71



RS4RC

4-pt. Suspension

- 4-point Flex-Gear® ratchet suspension
- Large absorbent cotton brow pad
- Replacement brow pads available (RBPCOTTON, RBPVINYL, RBPCOOL)
- Flex-points and nape cushion
- Large, easy-to-turn ratchet knob
- For Models S51, S61, S62, and S71



RS4PP

4-pt. Suspension

- 4-point self-sizing pinlock suspension
- Large poly brow pad
- Replacement brow pads available (RBPCOTTON, RBPVINYL, RBPCOOL)
- Vertical height adjustments (two front, two rear)
- For Models S51, S61, S62, and S71



RS4RP











4-pt. Suspension

- 4-point Flex-Gear® ratchet suspension
- Large poly brow pad
- Replacement brow pads available (RBPCOTTON, RBPVINYL, RBPCOOL)
- Flex-points and nape cushion
- Large, easy-to-turn ratchet knob
- For Models S51, S61, S62, and S71



Classic and Standard Series Hard Hats and Caps

Classic and Standard Series Replacement Parts and Accessories

RBPCOTTON	Brow Pad <ul style="list-style-type: none">• Large, absorbent cotton replacement brow pad• Fits all Bullard suspensions• Easy, Velcro® design	
RBPVINYL	Brow Pad <ul style="list-style-type: none">• Vinyl replacement brow pad• Fits all Bullard suspensions• Easy, Velcro® design	
RBPCOOL	Brow Pad <ul style="list-style-type: none">• Polartec replacement brow pad• Wicking material moves sweat away from the worker's brow• Fits all Bullard suspensions• Easy, Velcro® design	
R160	Ratchet Cover <ul style="list-style-type: none">• Leather ratchet cover• Fits all Bullard ratchet suspensions	
ES42	2-Point Elastic Chinstrap, Natural <ul style="list-style-type: none">• Latex-free, natural elastic• For Models S51, S61, S62, S71, C30, C33, C34, 911C, 911H, and Bump Cap	
ES42B	2-Point Elastic Chinstrap, Black <ul style="list-style-type: none">• Latex-free, black elastic• For Models S51, S61, S62, S71, C30, C33, C34, 911C, 911H, and Bump Cap	
ES3	3-Point Elastic Chinstrap, Black <ul style="list-style-type: none">• Latex-free, black elastic• For Models S61, S62	
R50	2-Point Nomex® Chinstrap, black <ul style="list-style-type: none">• Nomex chinstrap with postman's slide fastener• For Models S51, S61, S62, S71, C30, C33, C34, 911C, 911H, and Bump Cap	
GC100	Goggle Clips <ul style="list-style-type: none">• Self-adhesive• Set of three	
30013	Slot Plugs <ul style="list-style-type: none">• Flexible plugs for hard hat accessory slots• Set of two• For Models S51, S61, S62, and C30	



Classic and Standard Series Hot Weather and UV Accessories

Bullard offers hard hat wearers a variety of inexpensive accessories that help block the sun’s dangerous ultraviolet rays, keep workers cool, and enhance their productivity on the job. While Bullard hard hats and caps shade the worker’s head from direct sunlight, these accessories provide added protection from the discomforts associated with overexposure to the sun.

- CSS** Cotton Sunshade
- 100% cotton sunshade
 - For all helmets, hard hats, and caps
 - Protects neck from sun exposure and UV radiation
 - Attaches with three Velcro® strips that are provided
 - Hard hat not included



- SS5** Sun Shield
- “See through” front for overhead visibility
 - Extends hat brim 360 degrees to protect face, neck, and ears from sun exposure
 - Fits Models S51, S61, S62, C30, and 911C
 - Hard hat not included



- SS6** Sun Shield
- Same as Model SS5 above
- Fits Models S71, C33, C34, and 911H
 - Hard hat not included



- UBG** Underbrim Anti-Glare Decal
- Reduces glare
 - For all helmets, hard hats, and caps
 - Hard hat not included



- ECB** Evaporative Cooling Beanie
- Submerge in water for 1-2 minutes
 - Fits all hard hats and caps
 - Hard hat not included



- ECCN** Evaporative Cooling Crown and Neck Shade
- Submerge in water for 1-2 minutes
 - Fits all hard hats and caps
 - Hard hat not included



Bump Caps

The Bump Cap. Combines comfort and protection with style.

Designed for industries such as meat and food processing, utility meter reading, pest control, fruit harvesting, and auto repair, models Bump Cap (BC) and First Base® (FB) offer a variety of user options. Bullard bump caps provide limited protection against minor bumps and abrasions but are not designed for applications requiring ANSI approved head protection.

Bullard Bump Cap

The Bullard Bump Cap offers wearers a sleek style combined with user comfort and maximum versatility to provide the ultimate protection against minor bumps, bruises, and lacerations. Equipped with a technologically advanced double-hoop design for greater reinforcement and durability along with an easy-to-assemble user replaceable suspension, the Bullard Bump Cap offers unmatched comfort with a secure fit. Bullard Bump Caps may be customized with pad printed logos using up to six colors in as many as four different locations.

First Base®

The First Base bump cap combines comfort and protection for the wearer in the style of a baseball cap. It has a lightweight design and benefits in strength and protection from a low-density polyethylene liner. An inner foam pad is also included to provide all-day user comfort. The simple one-size-fits-all adjustment ensures a superior fit for all workers.

This cap comes standard with six eyelet holes for superior ventilation. Monogramming is available for a fully customized look.



Available Bump Cap (BC) Colors

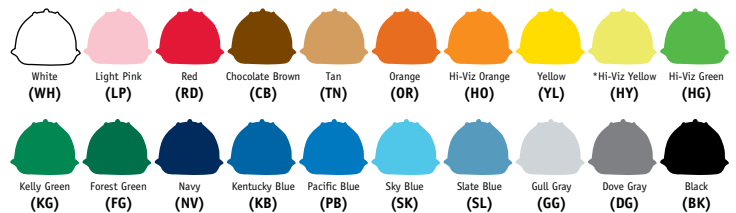

*Meets ANSI/ISEA Z89.1-2009 non-mandatory performance visibility requirements

Available First Base (FB) Colors





Bump Caps

Bullard Bump Cap

- BCV** Bullard Bump Cap
- Double-hoop design for greater durability
 - 4-point adjustable suspension system with vinyl brow pad (BCHBV)
 - Accommodates the widest array of head sizes of any bump cap on the market ranging from 6 3/8" to 8 1/4"
 - Compatible with Bullard Brackets 100G, 300B, and 300BW
 - Compatible with all Bullard visors
 - Case quantity: 25; minimum order: 25



BCKGP

- BCP** Bullard Bump Cap
- Same as BCV
 - 4-point adjustable suspension system with poly brow pad (BCHBP)

Bullard Bump Cap Replacement Parts and Accessories

Replacement Suspensions

- BCHBV** Replacement Suspension with Vinyl Brow Pad (shown)
- BCHBP** Replacement Suspension with Poly Brow Pad

Replacement Brow Pads

- BCRBPV** Replacement Vinyl Brow Pad
- BCRBPP** Replacement Poly Brow Pad



BCHBV

- ES42** 2-Point Elastic Chinstrap, Natural
- Latex-free, natural elastic
 - For Models S51, S61, S62, S71, C30, C33, C34, 911C, 911H, and Bump Cap



- ES42B** 2-Point Elastic Chinstrap, Black
- Latex-free, black elastic
 - For Models S51, S61, S62, S71, C30, C33, C34, 911C, 911H, and Bump Cap



Bump Caps

First Base®

- FB2000** Ventilated Cap
- Six sewn eyelet holes
 - Low-density polyethylene liner
 - Includes foam pad



Available in seven colors:



First Base Replacement Parts

- FBINSHELL** Inner Liner
- Low-density polyethylene
 - Includes foam pad
 - Fits most baseball style caps



- FBFOAM** Foam Pad for First Base Bump Cap



Custom Embroidery Available

- 24-piece minimum on custom embroidered caps
- Logos can be embroidered on front of cap
- Embroidered sample provided for approval
- One time digitization fee on initial order
- contact Customer Service for details



Industrial Head Protection Replacement Parts and Accessories

Bullard Hard Hat Replacement Parts and Accessories Guide											
Part Number	Description	C30	S51	S61/ S62	911C	C33/ C34	S71	911H	Advent®	Vector	Bump Cap
Replacement Suspensions											
RS6PC	Replacement Suspension, 6pt, Pinlock, Cotton Brow Pad	X				X					
RS6RC	Replacement Suspension, 6pt, Ratchet, Cotton Brow Pad	X				X					
RS4PP	Replacement Suspension, 6pt, Pinlock, Poly Brow Pad		X	X			X				
RS4PC	Replacement Suspension, 6pt, Pinlock, Cotton Brow Pad		X	X			X				
RS4RP	Replacement Suspension, 6pt, Ratchet, Poly Brow Pad		X	X			X				
RS4RC	Replacement Suspension, 6pt, Ratchet, Cotton Brow Pad		X	X			X				
FRS6PC	Replacement Suspension, 6pt, Pinlock, Cotton Brow Pad				X			X			
FRS6RC	Replacement Suspension, 6pt, Ratchet, Cotton Brow Pad				X			X			
ADRTSL	Replacement Suspension, 8pt, Ratchet, Vinyl Brow Pad								X		
VT600	Replacement Suspension, 4pt, Pinlock, Sportek Brow Pad									X	
VTRT600	Replacement Suspension, 4pt, Ratchet, Sportek Brow Pad									X	
BCHBV	Replacement Suspension with Vinyl Brow Pad										X
BCHBP	Replacement Suspension with Poly Brow Pad										X
Accessories and Replacement Parts											
ES42	Chinstrap, 2-point, latex-free elastic, natural	X	X	X	X	X	X	X	X	X	X
ES42B	Chinstrap, 2-point, latex-free elastic, black	X	X	X	X	X	X	X	X	X	X
GC100	Goggle Clips, self-adhesive	X	X	X	X	X	X	X	X	X	X
R160	Ratchet Cover, leather	X	X	X	X	X	X	X	X	X	
R50	Chinstrap, 2-point, Nomex® with postman's slide, black	X	X	X	X	X	X	X			
RBPCOTTON	Cotton Replacement Brow Pad	X	X	X	X	X	X	X			
RBPVINYL	Vinyl Replacement Brow Pad	X	X	X	X	X	X	X			
RBPCOOL	Polartec Replacement Brow Pad	X	X	X	X	X	X	X			
30013	Accessory Slot Plugs	X	X	X							
ES3	Chinstrap, 3-point, latex-free elastic with chin cup, black			X							
A110	Chinstrap, 2-point, nylon, black								X	X	
A101	Vinyl Replacement Brow Pad								X		
TT3	Sportek Replacement Brow Pad									X	
BCRBPV	Vinyl Replacement Brow Pad										X
BCRBPP	Poly Replacement Brow Pad										X
Hot Weather and UV Accessories											
UBG	Underbrim Anti-Glare Decal	X	X	X	X	X	X	X	X	X	X
ECB	Evaporative Cooling Beanie	X	X	X	X	X	X	X	X	X	X
ECCN	Evaporative Cooling Crown and Neck Shade	X	X	X	X	X	X	X	X	X	X
CSS	Cotton Neck Sunshade	X	X	X	X	X	X	X			X
SS5	Sun Shield	X	X	X							
SS6	Sun Shield					X	X	X			



Bullard[®]

LOGO SHOP



Customizing your hard hat has never been easier on ***Build Your Bullard!***

The hard hat is one of the most recognized pieces of safety equipment on any work site. Take advantage of this opportunity to advertise company products or services, improve worker visibility, and identify worker differentiation. Whether you supply camera-ready artwork or your logo on a business card or letterhead, Bullard will create a hard hat that comes alive to promote your organization's unique identity.

Quality Printing

Pad printed logos are permanent and will not peel, crack, or fade like a decal or sticker.

Order Size

Twenty piece minimum order required for custom logo work.

Pricing

No hidden charges. No set-up charges. No artwork charges.

Delivery

Bullard Logo Shop offers the fastest delivery in the industry.

Pad printed logos are permanent and will not peel, crack, or fade like a decal or sticker. Bullard uses the latest technology available to print clear, crisp logos in up to six different colors per logo - up to eight different locations around the cap - on any Bullard helmet, hat, or cap. We also offer a variety of Scotchlite[®] striping options in various colors and reflectivity. Stripes can be applied around the brim or between the ribs of the hat. Decorative stripe colors are available to accent your custom logo, or use fluorescent and highly reflective stripes to improve worker visibility.

Build Your Bullard lets you customize your hard hat quickly and easily. Just log on to www.BuildYourBullard.com to configure your hat.



Advanced Series
A1, A2, VT



Classic Series
30, 33, 34



Standard Series
51, 61, 62, 71



High Heat Series
9C, 9H



Bump Caps
BC

STANDARD COLORS	Abbreviation	PMS Color	ADVENT® A1, A2	VECTOR VT	CLASSIC 30, 33, 34, BC	STANDARD 51, 61, 62, 71	HIGH HEAT 9C, 9H
White	WH	n/a	•	•	•	•	•
Light Pink	LP	1895C			•	•	
Red	RD	186C	•	•	•	•	•
Chocolate Brown	CB	469			•	•	
Tan	TN	729C			•	•	
Orange	OR	173C	•	•	•	•	•
Hi-Viz Orange	HO	021C		•	•	•	
Yellow	YL	109C	•	•	•	•	•
Hi-Viz Yellow	HY	387C		•	•	•	
Hi-Viz Green	HG	361C			•	•	
Kelly Green	KG	348C			•	•	
Forest Green	FG	3425C		•	•	•	
Navy	NB	289C			★	★	
Kentucky Blue	KB	301U	•	•	•	•	•
Pacific Blue	PB	300C			•	•	
Sky Blue	SK	2985C			★	★	
Slate Blue	SL	549C			★	★	
Gull Grey	GG	428C			★	★	
Dove Grey	DG	424C			•	•	
Black	BK	n/a			•	•	

• - Cap/hat available in this color at a standard four business day lead time.

Special colors available: 500-piece minimum. Contact the Bullard Customer Service Department for pricing and lead time. Must furnish PMS number or color match sample.

★ - Cap/hat available in this color at an extended 10 business day lead time.

Follow these steps for simple and easy hard hat ordering

- 1 Start with the hard hat model number 2-digit code (listed above).
2. Add the 2-letter color code (listed above).
3. Add one letter for your choice of the suspension (listed below).
4. If you have a custom pad printed hard hat, you may include the *Build Your Bullard* (BYB) project number at the end of the part number for convenient ordering.

Example:

Model # + Color + Suspension = Part Number
30 RD R 30RDR

Model # + Color + Suspension + Logo = Part Number
61 YL P BYB12345 61YLPBYB12345

Choose your hard hat suspension

Abbreviation	Hard Hat Models
S (Standard)	A1, A2
R (Ratchet)	VT, 30, 33, 34, 51, 61, 62, 71
P (Pinlock)	VT, 30, 33, 34, 51, 61, 62, 71, BC
V (Pinlock, Vinyl)	BC



Hard Hat Colors

Brilliant Headgear

In choosing a color, it is important to consider the work surroundings. Available in hi-viz orange, yellow, and green, you can select the most appropriate contrasting color for the job site to ensure workers get noticed. These true fluorescent colors are visible under a black light and provide the greatest visible color impact. Bullard's *Hi-Viz Yellow passes ANSI/ISEA Z89.1-2009 non-mandatory high-visibility standard.

Hard Hat Color Selection

Bullard offers 20 of the most popular standard colors for our high-density polyethylene hats and caps. Our wide selection of colors is sure to meet your company's needs. Special colors are available upon request. Minimum volumes apply.

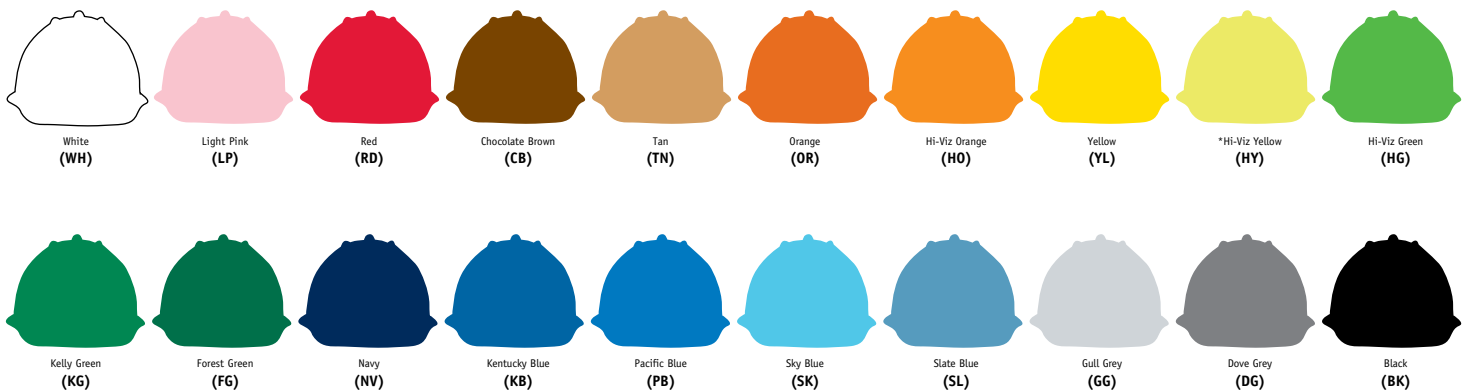

Decoration for Hard Hats and Caps

Logo Size Chart (by hat model)

Hat/Cap Model	Dimensions	Maximum Size		
		Front	Side	Back
S51	Width (length) Height	2 1/8" 2 3/4"	4" 1 3/4"	2 3/4" 2 1/2"
S61, S62	Width (length) Height	2 1/4" 2"	3 1/4" 1 1/2"	2" 2"
S71	Width (length) Height	2" 2"	3 3/4" 1 3/4"	2 3/4" 1 3/4"
C30, C33, C34 911C, 911H	Width (length) Height	2 3/4" 2 1/2"	4" 1 3/4"	2 3/4" 2 1/2"
Advent® A1, A2, Vector	Width (length) Height	3" 3"	4" 1 3/4"	3" 3"
BC	Width (length) Height	3" 1 1/2"	2 1/2" 2"	1 1/2" 1 1/4"

Models S61, S62, and S71 have a low profile with more curvature, which may require that some logos be printed smaller than listed above. Bullard will print all logos to maximum size allowed based on the logo design and shape, unless otherwise specified. Bullard must receive artwork before exact logo size can be determined.

Note: The size may vary on square or rectangular logos.





Follow these simple steps to configure YOUR Bullard Hard Hat or Bump Cap

1. Go to www.BuildYourBullard.com
2. Select Head and Face Protection and your desired model.
3. Register and Sign In to request a proof!
4. Build your custom hat with your logo!

Camera Ready vs. Non-Camera Ready

Example of Camera Ready Artwork:



Example of Non-Camera Ready Artwork:



Camera Ready Means...

- Faster proof turn around time in just three (3) business days
- Precise logo reproduction

Typical Camera Ready art file extensions include:

- .eps (Vector EPS)
- .pdf (Vector PDF)
- .ai (Illustrator)
- .fh (Freehand)
- .cdr (Corell Draw)

Non-Camera Ready Means...

- Longer proof turn around time (5-7 business days)
- Must supply Pantone® colors

Typical Non-Camera Ready art file extensions include:

- .tiff (Tag Image File Format)
- .jpg, .jpeg (Joint Photographic Experts Group)
- .pdf (Raster PDF)
- .png (Portable Network Graphics)

Mixing Cap Colors or Models on an Order

- Colors: A minimum order of 20 pieces is required per cap/hat color. Colors can be mixed (with a minimum of 20 per color) to meet a higher quantity logo price break, providing that the logo and configuration remain the same.
- Models: Cap and hat models cannot be mixed to meet a logo price break.

Logo Archiving

Bullard will archive logos for up to 24 months. If a logo has not been used within two years, we request that new artwork be submitted and a new proof approved.

Tips for getting camera-ready artwork:

1. Ask your customer for vector or line art or the original art used to print business cards, signs, letterhead, etc.
2. Ask for art that has been converted to points and paths and includes any embedded files.
3. Remember that, in most cases, neither you nor your customer may be able to open the file. That's usually the file we need.

Decoration for Hard Hats and Caps

Stock Logos

If you don't have your own artwork to use on your decorated Bullard hard hat, you might find something in our selection of stock logos.



Stock Logos Available:



PP290



THINK SAFETY

PP24689



PP6460

VISITOR

PP5009



PP24870



PP6122

**MORE AVAILABLE
ON OUR
WEBSITE**

www.bullard.com
www.BuildYourBullard.com

Reflective Striping

Reflective Stripes for Classic and Standard Series Hats and Caps

Single color reflective Scotchlite® brand stripes are available for improved visibility and work group identification. Bullard offers striping in two locations - around the brim and between the ribs (two stripes) of the hat.

To receive stripe pricing and delivery for multi-colored stripes or special requirements, please contact Bullard Customer Service. An application fee will apply (per hat) if Bullard applies the striping.

Striping Options for Classic Series

Factory Applied Part # Code

Around the Brim 1 1/16" wide x 23" long

ST1R500	Highly Reflective Silver Stripe, 500 CPL	S5
ST1RORG175	Fluorescent Orange Stripe, 175 CPL	O7
ST1RBLU	Blue Reflective Strip, 10 CPL	B1
ST1RGRN	Green Reflective Stripe, 15 CPL	G1
ST1RORG	Orange Reflective Stripe, 25 CPL	O1
ST1RRD	Red Reflective Stripe, 20 CPL	R1
ST1RWHT	White Reflective Stripe, 100 CPL	W1
ST1RYLW	Yellow Reflective Stripe, 60 CPL	Y2



Model C30 with ST1R00 stripe 30YLRRS5

Between the Ribs 3/8" wide x 20" long

ST2RBLU	Blue Reflective Stripe, 10 CPL	B2
ST2RGRN	Green Reflective Stripe, 15 CPL	G2
ST2RORG	Orange Reflective Stripe, 25 CPL	O2
ST2RRD	Red Reflective Stripe, 20 CPL	R2
ST2RWHT	White Reflective Stripe, 100 CPL	W2
ST2RYLW	Yellow Reflective Stripe, 60 CPL	Y2



Model C30 with ST2RWHT stripe 30WHRW2

Striping Options for Standard Series

Around the Brim 1" wide x 21 1/2" long

STRSS500	Highly Reflective Silver Stripe, 500 CPL	I5
STRSSORG175	Fluorescent Orange Stripe, 175 CPL	O10
STRSSBLU	Blue Reflective Stripe, 10 CPL	SB
STRSSGRN	Green Reflective Stripe, 15 CPL	SG
STRSSORG	Orange Reflective Stripe, 25 CPL	SO
STRSSRED	Red Reflective Stripe, 20 CPL	SR
STRSSWHT	White Reflective Stripe, 100 CPL	SW
STRSSYLW	Yellow Reflective Stripe, 60 CPL	S4



Model S71 with ST2RWHT stripe 71YLRSW

Standard Stripe Colors for ST1R, ST2R, and STRSS

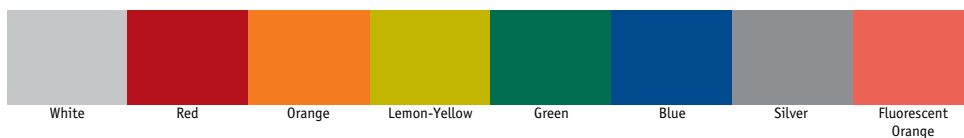

Striping Options for Classic Series and Standard Series Factory Applied Part # Code

Three piece Around the Brim 1" wide x 4" long

R538	Retro-Reflective 500 CPL White ScotchLite® Stripes	R8
R540	Retro-Reflective 175 CPL Lime-Yellow ScotchLite Stripes	R6
R541	Retro-Reflective 175 CPL Red-Orange ScotchLite Stripes	R7



R541



Candle Power of Reflective Stripes (CPL)

Bullard Model Number	Stripe Daytime Color	Stripe Reflected Color	Typical Brightness (Candle Power)
STRSS/ST1R/ST2RWHT	White	White	100
STRSS/ST1R/ST2RRED	Red	Red	20
STRSS/ST1R/ST2RORG	Orange	Orange	25
STRSS/ST1R/ST2RYLW	Yellow	Yellow	60
STRSS/ST1R/ST2RGRN	Green	Green	15
STRSS/ST1R/ST2RBLU	Blue	Blue	10
ST1R500	Silver	White	500
STRSS500	Silver	White	500
ST1RORG175	Fluorescent Red-Orange	White	175
STRSSORG175	Fluorescent Red-Orange	White	175
R538	Silver	White	500
R540	Fluorescent Lime-Yellow	White	175
R541	Fluorescent Red-Orange	White	175

Custom striping available upon request.

Save time by ordering factory-applied stripes

To order your hard hat with the stripe applied, add the following codes to the end of your hard hat part number.

1. Start with the hard hat model number 2-digit code (on page 28).
2. Add the 2-letter color code (on page 28).
3. Add one letter for your choice of the suspension (on page 28).
4. If you have a custom pad printed hard hat, you may include the *Build Your Bullard* (BYB) project number at the end of the part number for convenient ordering.
4. Add any accessories that are factory applied.

Example:

Model # + Color + Suspension + Stripe = Part Number
 30 YL R S5 30YLR55 (shown on page 33)

Face Protection

Headgear. Brackets. Visors. Lightweight, comfortable face protection.

Sentinel Series Headgear

For the ultimate value in lightweight, comfortable face protection, Bullard Sentinel Series headgear is the obvious choice.

All Sentinel Series headgear include two sizing features for enhanced comfort. The ratchet adjusts the headband to sizes 6¹/₂" to 8" and will not slip from the selected size. The crown strap conforms to the shape of the head. The brow pad, made of Sportek and offered exclusively by Bullard, pulls moisture away from the skin, creating a drier, more comfortable fit. Brow pads are hand washable and replaceable. Sentinel easily accommodates both primary eye protection and half-facepiece style respirators.

Hard Hat Mounted Face Protection

When the job calls for both head and face protection, choose from our complete line of dielectric nylon or gold anodized aluminum brackets. Brackets are available in several mounting styles that attach securely to Bullard hard hats and caps.

Dielectric brackets are formed from lightweight, durable nylon and are ideal for general duty applications. Bullard Gold Line brackets are constructed from rugged, gold anodized aluminum. They are highly resistant to corrosion and heat and are ideal for chemical handling and high-heat industrial applications.

Visors

Bullard visors conform to ANSI/ISEA Z87.1-2010 standard for eye and face protection when used in combination with Bullard headgear or faceshield.



Bullard Visor Applications

Activity	Hazards	Impact Protection Needed	Suggested Visor Material	Appropriate Bullard Visor Models
Chemical handling	Chemical splash or spill, acid burns, fumes, glass breakage	Z87	Acetate, Tritan™	640M, 840M, 1040, CS40, 680T, 840MX2, 840TX2, 840T, 860T, 880T, WS60TM
Laboratory operations	Chemical splash or spill, acid burns, fumes, glass breakage	Z87	Acetate, Tritan	640M, 840M, 1040, CS40, 680T, 840MX2, 840TX2, 840T, 860T, 880T, WS60TM
Grinding	Flying particles, dust	Z87+	Polycarbonate, Tritan	640P, 640PW3, 640PW5, 840P, 860P, 880P, WS60PM, 680T, 840PW3, 840PW5, 840PX2, 840TX2, 840T, 860T, 880T, WS60TM
Sawing	Flying particles, dust	Z87+	Polycarbonate, Tritan	640P, 840P, 860P, 880P, WS60PM, 680T, 840T, 860T, 880T, WS60TM
Machining	Flying particles, mists, vapors	Z87+	Polycarbonate, Tritan	640P, 840P, 860P, 880P, WS60PM, 680T, 840PX2, 840TX2, 840T, 860T, 880T, WS60TM
Medical examinations, first aid	Contact with body fluids/bloodborne pathogens	Z87	Acetate, Tritan	640M, 840M, 1040, CS40, 680T, 840PX2, 840TX2, 840T, 860T, 880T, WS60TM
Pesticide/fertilizer application	Chemical splash or spill, airborne chemicals	Z87	Acetate, Tritan	640M, 840M, 1040, CS40, 680T, 840T, 860T, 880T, WS60TM
Spray cleaning, (dirt, grime, etc.)	Flying particles, mists, splash	Z87	Polyester	840ME, E840ME
Molten metal handling	Molten splash	Z87	Polycarbonate	680P, 840P, 840PX2, 840TX2, 860P, 880P, WS60PM
Tree trimming	Flying particles	Z87	Mesh Screen	6S24, 8S24
Soldering, brazing	Infrared light, flying particles	Z87+	Polycarbonate	640PW3, 640PW5, 840PW3, 840PW5, 840PX2W3, 840PX2W5

Face Protection

Sentinel Headgear

The Bullard Sentinel Series headgear offers the ultimate value in lightweight, comfortable face protection. This lightweight molded ABS plastic headgear is non-conductive when used with a non-conductive visor. It includes a Flex-Gear® ratchet suspension and a Sportek brow pad to pull moisture away from the skin. Available with or without a chin protector.

SENTINEL1

Faceshield Headgear

- Faceshield sold separately
- Standard headgear with black ABS crown protector
- Flex-Gear® ratchet sizing with Sportek brow pad (TT3)
- For use with Bullard faceshields
- Meets or exceeds ANSI/ISEA Z87.1-2010



SENTINEL2

Faceshield Headgear

- Faceshield sold separately (840TX2, 840MX2, 840PX2, 840PX2W3 OR 840PX2W5)
- Standard headgear with black ABS crown and chin protector combination
- Flex-Gear® ratchet sizing with Sportek brow pad (TT3)
- Meets or exceeds ANSI/ISEA Z87.1-2010



CP1

Chin Protector

- Black ABS replacement chin protector
- For use with 840MX2, 840PX2, 840TX2, 840PX2W3, and 840PX2W5



CP2

Chin Protector

- Clear polycarbonate replacement chin protector
- For use with 840MX2, 840PX2, 840TX2, 840PX2W3, and 840PX2W5

Acetate

840MX2

Visor

- 7" x 15" x .040"
- Clear flat acetate visor
- Holes at bottom of visor to accommodate chin protector - Should be used with CP1/CP2 only
- Meets ANSI/ISEA Z87.1-2010, Z87, Non-impact Protector Testing Requirements



Polycarbonate

Meets ANSI/ISEA Z87.1-2010, Z87+, Impact Protector Testing Requirements

840PX2

Visor

- 7" x 15" x .040"
- Clear heat-formed polycarbonate visor
- Holes at bottom of visor to accommodate chin protector - Should be used with CP1/CP2 only



840PX2W3

Visor

- 7" x 15" x .040"
- Shade 3 polycarbonate visor
- Holes at bottom of visor to accommodate chin protector - Should be used with CP1/CP2 only



840PX2W5

Visor

- 7" x 15" x .040"
- Shade 5 polycarbonate visor
- Holes at bottom of visor to accommodate chin protector - Should be used with CP1/CP2 only



Tritan™

840TX2

Visor

- 7" x 15" x .040"
- Clear heat-formed Tritan™ visor
- Holes at bottom of visor to accommodate chin protector - Should be used with CP1/CP2 only
- Meets ANSI/ISEA Z87.1-2010, Z87+, Impact Protector Testing Requirements



Face Protection

Nylon Brackets

Dielectric brackets are formed from lightweight, durable nylon and are ideal for general-duty applications.



33YLR with
312B Bracket
and 840T
Faceshield

- 300B** Dielectric Bracket
- Front mounting nylon bracket
 - For cap style Models S51, S61, S62, C30, Advent®, and Bump Cap



- 300BW** Dielectric Bracket
- Front mounting nylon bracket with neoprene gasket
 - For cap style Models S51, S61, S62, C30, Advent®, and Bump Cap



- 312B** Dielectric Bracket
- Front mounting nylon bracket
 - For full-brim hat Model S71, C33, and C34



- 400** Dielectric Bracket
- Front mounting nylon bracket with blades for accessory slot attachment
 - For slotted cap style Models S51, S61, S62, and C30



- 400W** Dielectric Bracket
- Front mounting nylon bracket with neoprene gasket and blades for accessory slot attachment
 - For slotted cap style Models S51, S61, S62, and C30





Face Protection

Aluminum Brackets

Gold Line brackets are constructed from rugged, gold-anodized aluminum. They are ideal for chemical handling and high heat applications.

- 100G** Gold Line Bracket
- Front mounting aluminum bracket
 - For cap style Models S51, S61, S62, C30, 911C, and Bump Cap



- 110G** Gold Line Bracket
- Back mounting aluminum bracket
 - For cap style Models S51, S61, S62, C30, and 911C

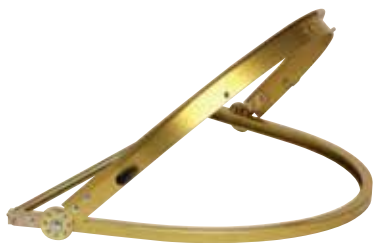

- 112G** Gold Line Bracket
- Front mounting aluminum bracket
 - For full-brim hat Models S71, C33, C34, and 911H



- 500M** Gold Line Bracket
- Front mounting aluminum bracket with blades for accessory slot attachment
 - For cap style Model C30



Face Protection

Multi-Fit Faceshield Visors

Bullard visors are designed to provide limited protection to the face from many hazards. When used with Bullard brackets, all visors conform to ANSI/ISEA Z87.1-2010 for faceshields. For maximum versatility, all Bullard visors fit all Bullard brackets and most competitive models. These visors are available in a variety of materials and sizes for specific applications, environments, and performance needs.

Tritan™ Visors - Chemical Splash, Impact Resistance

- Clear Tritan visor for all Bullard brackets and several competitive models
- Meets ANSI/ISEA Z87.1-2010, Z87+, Impact Protector Testing Requirements

- 680T***
- 6" x 15" x .080"
 - heat-formed



- 840T**
- 8" x 15" x .040"
 - heat-formed

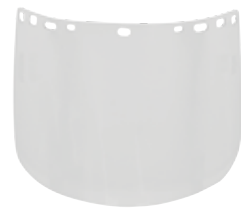

- 860T**
- 8" x 15" x .060"
 - heat-formed



- 880T**
- 8" x 15" x .080"
 - heat-formed

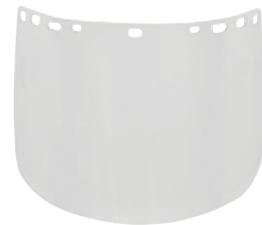

- WS60TM**
- 9" x 19 3/4" x .060"
 - flat visor



Dark Green Acetate Visors - Chemical Splash Resistance

- Dark green flat acetate visor for all Bullard brackets and several competitive models
- 14± 4 percent visible light transmittance
- Meets ANSI/ISEA Z87.1-2010 Non-impact Protector Testing Requirements

- 640G***
- 6" x 15" x .040"
 - flat visor



- 840MG**
- 8" x 15" x .040"
 - flat visor



*Not a multi-fit visor

Face Protection

Multi-Fit Faceshield Visors

Acetate Visors - Chemical Splash Resistance

- Clear acetate visor for all Bullard brackets and several competitive models
- Meets ANSI/ISEA Z87.1-2010 Non-impact Protector Testing Requirements

- 1040**
- 10" x 15" x .040"
 - flat visor



- 640***
- 6" x 15" x .040"
 - flat visor



- 840M**
- 8" x 15" x .040"
 - flat visor



- CS40**
- 9" x 19 3/4" x .040"
 - Specially designed for chemical splash applications
 - flat visor



- 840MH**
- 8" x 15" x .040"
 - heat-formed



- 860H**
- 8" x 15" x .060"
 - heat-formed



Polycarbonate Visors - Impact Resistance

- Clear polycarbonate visor for all Bullard brackets and several competitive models
- Meets ANSI/ISEA Z87+, Testing Requirements

- 680P***
- 6" x 15" x .080"
 - heat-formed



*Not a multi-fit visor



Face Protection

Multi-Fit Faceshield Visors

Polycarbonate Visors - Impact Resistance continued

- 840P**
- 8" x 15" x .040"
 - heat-formed



- 860P**
- 8" x 15" x .060"
 - heat-formed



- 880P**
- 8" x 15" x .080"
 - heat-formed



- WS60PM**
- 9" x 19 3/4" x .060"
 - flat visor



Polycarbonate Shade Visors - Impact Resistance

- Polycarbonate visor for all Bullard brackets and several competitive models
- Meets ANSI/ISEA Z87.1-2010, Z87+, Impact Protector Testing Requirements

- 640PW3***
- 6" x 15" x .040"
 - Shade 3
 - flat visor



- 640PW5***
- 6" x 15" x .040"
 - Shade 5
 - flat visor



- 840PW3**
- 8" x 15" x .040"
 - Shade 3
 - flat visor



- 840PW5**
- 8" x 15" x .040"
 - Shade 5
 - flat visor



*Not a multi-fit visor

Face Protection

Multi-Fit Faceshield Visors



Polyester Visors - Splash Resistance

- Clear flat visor for all Bullard brackets and several competitive models
- Meets ANSI/ISEA Z87.1-2010 Non-impact Protector Testing Requirements

- 840ME**
- 8" x 15" x .040"
 - flat visor



- E840ME**
- 8" x 15" x .040"
 - economical
 - flat visor



Mesh Screen Visor - Fog, Scratch Resistance

- Mesh black steel screen visor fits all Bullard brackets
- Meets ANSI/ISEA Z87.1-2010 Non-impact Protector Testing Requirements

- 8S24**
- 8" x 15" x 24 mesh
 - with aluminum band
 - flat visor



- 6S24***
- 6" x 15" x 24 mesh
 - with plastic band
 - flat visor



*Not a multi-fit visor

Visor Material Performance

	Acetate	Tritan™	Polycarbonate	Polyester	Mesh Screen
Clarity	Best	Better	Better	Good	N/A
Chemical splash	Best	Better	Fair	Low	N/A
Alkalines	Best	Better	Fair	Better	N/A
Acids	Best	Better	Fair	Better	N/A
Solvents	Good	Good	Good	Good	N/A
Temperature resistance	Good	Better	Best	Low	8S24 (Metal Frame) Best 6S24 (Plastic Frame) Low
Impact & penetration	Good	Better	Best	Low	Good
Fog resistance	Better	Good	Good	Good	Best
Scratch resistance	Best	Better	Best	Better	Best
UV radiation	Fair	Better	Best	Fair	N/A

Body Temperature Management

Worker comfort. Heat stress avoidance. Improved productivity. Bullard offers Body Temperature Management products to keep workers cool while on the job.

Isotherm® Cool Vest

Bullard revolutionary Isotherm® technology offers unparalleled cooling power. Unlike ice or gel packs that steadily lose their effectiveness, Bullard Isotherm® Cool Vests will remain at a CONSTANT 55°F for hours of cooling. Isotherm® can help reduce the chance of heat-related illnesses that sometimes occur in today's difficult work environments. Isotherm® is ergonomically designed, quick to recharge, and does not feel wet against the skin. It uses a simple, interchangeable front/back cool pack system that provides continuous cooling to the worker's upper body. The vests are easily adjustable for maximum comfort and flexibility. Dark blue vest material is flame retardant. Fits medium to extra-large sizes.

Isotherm® provides cooling for approximately 2½ hours. The period of cooling depends solely on work activity and environmental conditions. Weight: 6.5 lbs. (2.9kg).

The Isotherm® Class 2 provides the same revolutionary cooling while also meeting the ANSI/ISEA 107-2010 Class 2 high-visibility requirements. Wear this vest when working on or near roadways to meet the U.S. Dept. of Transportation Federal Highway Administration's *Manual on Uniform Traffic Control Devices*. Fits extra-large sizes only.

Isotherm® Replacement Packs

No waiting. No down time. Keep extra cool packs ready for instant on-site changes. Made of specially engineered plastic, Isotherm® packs are designed to expand up to 400% without damage. The cooling agent within the pack is a safe, non-toxic, and non-carcinogenic formulation. Cool packs may be re-energized thousands of times, providing hours of safe, controlled body temperature management. Placed in a cooler of ice water, the cool packs will fully recharge in approximately 20 minutes. However, ice water is not necessary as the phase change technology actually begins recharging the packs whenever they are placed in an environment that is cooler than 55° F.

Evaporative Cooling Vests

Stay cool for hours with Bullard's uniquely designed Evaporative Cooling Vest. The vest material is made to be submerged in cold water for 1-2 minutes. Once submerged, wring out the excess water, put the vest on, and stay cool for several hours. It's fast, easy, and convenient. The economical solution to keeping cool while on the job.



Isotherm® Cool Vest

- IS02** Isotherm® 2
- Cooling vest, fits medium to large sizes (32"-42")
 - Includes vest and one set of packs
 - Dark blue, flame retardant fabric



- IS02XL** Isotherm® 2 Extra-Large
- Cooling vest, fits XL and 2XL sizes (42"-52")
 - Includes vest and one set of packs
 - Dark blue flame retardant fabric



- ISOC2** Isotherm® Class 2
- Cooling vest accommodates XL sizes
 - Cooling vest meets ANSI/ISEA 107-2010 Class 2 high-visibility requirements
 - Includes vest and one set of packs
 - Fluorescent yellow and reflective striping

- ECVL** Evaporative Cooling Vest, Large (40" - 42")

- ECVXL** Evaporative Cooling Vest, Extra-Large (43" - 45")



- IS02P** Replacement Packs
- Isotherm® vests
 - One set of two packs (front and back)

- IS02V** Replacement Vest
- IS02, medium to large sizes (32"-42")
 - Includes vest only
 - Dark blue, flame retardant fabric

- IS02XLV** Replacement Vest
- IS02, XL and 2XL sizes (42"-52")
 - Includes vest only
 - Dark blue, flame retardant fabric

- ISOC2V** Replacement Class 2 Vest
- ISOC2 vest only, XL
 - Fluorescent yellow and reflective striping
 - Meets ANSI/ISEA 107-2010 Class 2 high-visibility requirements



The Turtle Club®: For People Who Do Things Right!

Founded 1946

Most news is made when things go wrong, but shouldn't employees get recognition for doing things right? That's the reason the Turtle Club® was founded. This organization is dedicated to saving lives and preventing injuries by promoting the acceptance and use of hard hats. Industrial accidents can happen anytime and anywhere, so wearing required head protection can reduce the risk of serious injury. The Turtle Club® honors men and women who escaped injury because they were wearing hard hats at the time of industrial accidents.

A Different Kind of Safety Incentive

Safety professionals are always looking for new ways to promote safety both on and off the job. While incentives and awards programs are excellent, most focus on accident prevention. The Turtle Club® is a participatory program for workers that have proven to be a valuable adjunct to traditional industry head protection safety efforts.

Over 50 Years and Still Going Strong

The Turtle Club® was founded in 1946 by C. R. "Rusty" Rustemeyer, Safety Director at Canadian Forest Products, Ltd. In 1950, Mr. Edward W. Bullard, Sr., was appointed the Turtle Club® sponsor. This appointment was particularly appropriate since, in 1919, Mr. Bullard developed the industry's first universally accepted hard hat, the original "Hard Boiled®" hat. Today, the club's international sponsor is Mr. E. D. "Jed" Bullard, grandson of E. W. Bullard. Because of Jed Bullard's commitment and efforts, interest in the club remains active, and membership continues to grow.

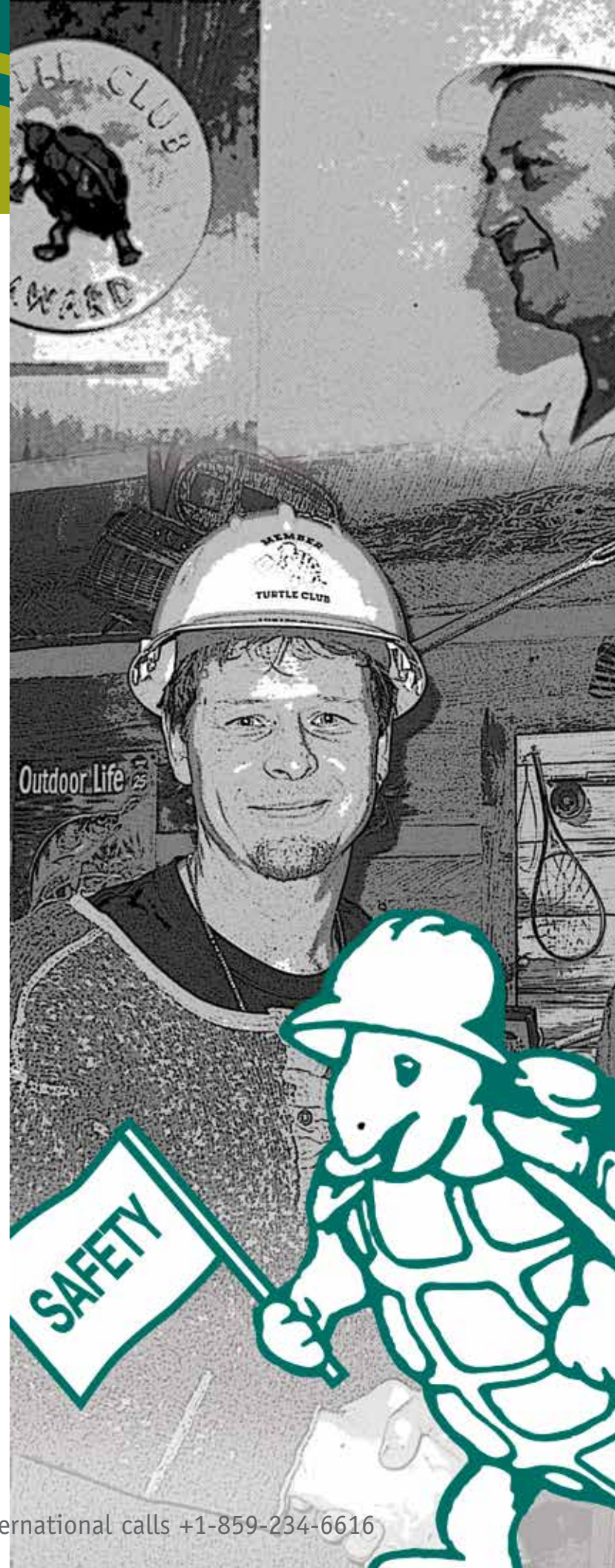

The Turtle Club®

A Tradition Continues

Membership requirements for The Turtle Club® are the same today as they were in 1946. Men and women who have escaped serious injury by wearing hard hats can be nominated for membership by their supervisor or company safety director. Each new member receives a new hard hat, membership certificate, membership card, Turtle Club® pin, and Turtle Club® decal. There are no dues or membership fees.

A Dedication to Safety

Members of the club pledge to "Practice safety, wear head protection when necessary, and to conscientiously encourage others to do so." This pledge, though more than 60 years old, is just as important today as it was six decades ago.

Joe Navarrete, Bullard Turtle Club® Member:

"While rigging combustion turbine air and fuel line piping on the bed of a pitman boom truck, Joe Navarrete's foot slipped. As he stood up to regain his balance, he stepped off the edge of the truck bed, landing on his right knee, left elbow, and his head. He stood up after the fall, actually returned to work the next day, sore and bruised but definitely happy that his Bullard hard hat saved his life."

-Chris Bornhauser

Nominate a Turtle Club® Member today at
www.bullard.com/TurtleClub





Respiratory Protection and Air Quality Products

Blasting and Grinding • Painting and Powder Coating • Welding
Clean Room Applications • Pharmaceutical Manufacturing •
Infection Control • Hospital Preparedness • Chemical Handling

877-BULLARD (285-5273) • International calls +1-859-234-6616

Warnings, Regulations, Standards, and Protection Factors Research for Respirators

Work Systems

Bullard offers totally configured work systems for use in a wide variety of applications - from painting and abrasive blasting to pharmaceutical and chemical manufacturing. Everything you need for effective respiratory protection is provided in one complete package.



Spectrum® Series
SPECLSYS



FAMB Series
FAMBSYS



GenVX™ Series
GENVSYS



CC20 Series
CC20SYS



GR50 Series
GR50SYS



Industry	Spectrum® Series	FAMB2 Series	GenVX™ Series	88VX Series	CC20 Series	RT Series	GR50 Series	EVA Series	EVAHL Series
Painting	•	•	•	•	•	•	•	•	•
Chemical Handling	•	•			•	•	•	•	•
Abrasive Blasting			•	•					
Grinding							•	•	
Healthcare					•	•		•	•
Pharmaceutical	•				•	•		•	•
Welding		•						•	

Respiratory Protection

Respiratory Protection Resources	
Respiratory Protection.....	50
Key Terms	50
OSHA Regulations	50
Assigned Protection Factors.....	54
Bullard Respirator Application Guide.....	55
Powered Air Purifying Respirator Selection Chart	57
Fittings Selection Guide	80, 175
CC20 Supplied Air Respirator Selection Chart.....	84
LF Series Selection Chart	100
RT Series SAR Selection Chart	108
GenVX™ Series SAR Selection Chart	117
88VX Series SAR Selection Chart	127
GR50 Series SAR Selection Chart	140
Spectrum® Series Selection Chart.....	150
Cubic Feet Per Minute Calculator.....	179
Clean Air Box (CAB) Selection Chart.....	188
Free-Air® Pump Selection Chart	195



⚠ WARNING

Consult product literature and instruction manuals for information on the proper function, use and maintenance of these respirators. Before using a Bullard respirator, Federal Law requires the employer to identify and evaluate the respiratory hazard(s) in the workplace including a reasonable estimate of employee exposure to respiratory hazard(s) and an identification of the contaminant's chemical state and physical form. Do not exceed maximum use concentrations established by OSHA, EPA, NIOSH, ACGIH or other regulatory standards.

In accordance with Title 42 Code of Federal Regulations Part 84 and 29 CFR 1910.134, respirator repairs or adjustments shall be made using only Bullard NIOSH approved parts designed for the respirator. Use of any other parts on these respirators VOIDS NIOSH APPROVAL. Failure to follow these instructions could result in death or serious injury.

What are the key terms?

- APF** - Assigned Protection Factor (APF) is the workplace level of respiratory protection that a respirator or class of respirators is expected to provide to employees when the employer implements a continuing, effective respiratory protection program.
- IDLH** - Immediately Dangerous to Life and Health (IDLH) means an atmosphere that poses an immediate threat to life, would cause irreversible adverse health effects or would impair an individual's ability to escape from a dangerous atmosphere.
- MUC** - Maximum use concentration (MUC) means the maximum atmospheric concentration of a hazardous substance from which an employee can be expected to be protected when wearing a respirator, and is determined by the assigned protection factor of the respirator or class of respirators and the exposure limit of the hazardous substance.
 $MUC = APF \times PEL \text{ or IDLH concentration (whichever is lower)}$.
- NIOSH** - National Institute for Occupational Safety & Health (www.cdc.gov/niosh) is a research organization that approves respirators.
- OSHA** - Occupational Safety & Health Administration (www.osha.gov) is an enforcement agency that ensures workplaces are following the standards detailed in 29 CFR 1910.134 and other standards.
- PEL** - The Permissible Exposure Limit (PEL) is the contaminant concentration enforced by OSHA

What is the OSHA Regulation for Respiratory Protection?

29 CFR 1910.134 is the OSHA standard for respiratory protection.

In any workplace where respirators are necessary to protect the health of the employee or whenever respirators are required by the employer, the employer shall establish and implement a written respiratory protection program with worksite-specific procedures. The program shall be updated as necessary to reflect those changes in workplace conditions that affect respirator use. The employer shall include in the program the following provisions of this section, as applicable:

- Procedures for selecting respirators for use in the workplace
- Medical evaluations of employees required to use respirators
- Fit testing procedures for tight-fitting respirators
- Procedures for proper use of respirators in routine and reasonably foreseeable emergency situations
- Procedures and schedules for cleaning, disinfecting, storing, inspecting, repairing, discarding, and otherwise maintaining respirators
- Procedures to ensure adequate air quality, quantity, and flow of breathing air for atmosphere-supplying respirators
- Training of employees in the respiratory hazards to which they are potentially exposed during routine and emergency situations
- Training of employees in the proper use of respirators, including putting on and removing them, any limitations on their use, and their maintenance
- Procedures for regularly evaluating the effectiveness of the program.

⚠ WARNING: Issuing a respirator does not constitute an OSHA compliant respiratory protection program.

An OSHA Compliant Respiratory Program	
IS	IS NOT
Written	Verbal
Work site specific	Generic
Regularly reviewed for effectiveness	Static
Trained upon regularly	Operated without training
	Simply issuing a respirator

Respiratory Protection

What is the difference between OSHA and NIOSH?

OSHA, the Occupational Safety and Health Administration, is part of the Department of Labor and is the agency that inspects a workplace for safety compliance. As part of that inspection, if respirators are being used, one of the things the inspector will check to see is that the respirator is NIOSH approved. NIOSH, the National Institute for Occupational Safety and Health, administers a testing and certification program assuring commercial availability of respiratory protective devices that conform to the requirements of Title 42, Code of Federal Regulations, Part 84. NIOSH tests and certifies (i.e. approves) respiratory protective devices and purchases certified products on the open market to verify continued compliance with the requirements of the 42 CFR, Part 84. NIOSH does not conduct jobsite compliance inspections and cannot issue fines for non-compliance.

How do I select a respirator?

According to OSHA, it is the responsibility of the employer to evaluate workplace hazards (if any) and implement appropriate controls to protect the worker. When engineering and/or administrative controls aren't technically or financially feasible, Personal Protective Equipment may be used to protect the worker. When respiratory PPE is needed, the following steps may be helpful as you select a respirator:

1. Identify the hazard(s) including:
 - Lack of Oxygen, Organic Vapor, Acid Gas, Particulate, Confined Space, Explosion Potential, etc.
2. Analyze the hazard(s) including:
 - Contaminant Concentration vs. the PEL & IDLH
 - MSDS, Air Sampling, NIOSH Guide to Chemical Hazards
 - Lower Flammable Limit
 - Boiling Point
 - Odor Threshold
 - Eye/Nose/Throat Irritation
 - Substance Specific Standards
3. Calculate the APF required
 - $APF = (\text{Contaminant Concentration}) / PEL$
4. Account for other considerations
 - Air source options (Compressor, Bottle, Ambient Air Pump, PAPR, APR)
 - Comfort (Length of time, Temperature)
 - Cost (Including fit testing and consumables)
5. Choose Respirator
 - Type: APR, PAPR, SAR, or SCBA
 - Head Top: Half-Mask, Full-Facepiece, Loose-Fitting Facepiece, Hood, Helmet
 - Evaluate Capabilities & Limitations

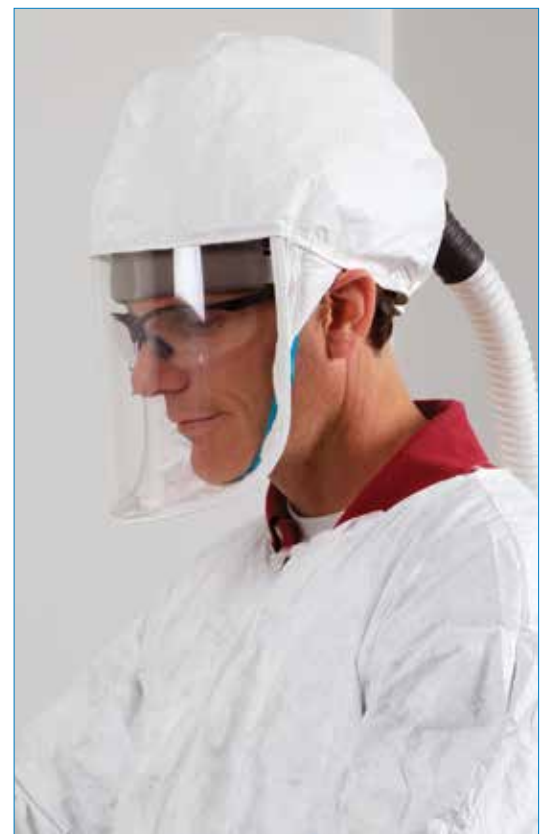

Who must receive a Medical Evaluation?

The employer shall provide a medical evaluation (at no cost to the employee) to determine the employee's ability to use a respirator, before the employee is fit tested or required to use the respirator in the workplace. A physician or other licensed health care professional (PLHCP) may perform medical evaluations using a medical questionnaire or an initial medical examination that obtains the same information as the medical questionnaire. The employer may discontinue an employee's medical evaluations when the employee is no longer required to use a respirator.

Respiratory Protection

How often must training be conducted?

Retraining shall be administered annually, and when the following situations occur:

- Changes in the workplace or the type of respirator render previous training obsolete
- Inadequacies in the employee's knowledge or use of the respirator indicate that the employee has not retained the requisite understanding or skill
- Any other situation arises in which retraining appears necessary to ensure safe respirator use

Who must be fit tested and how often?

The employer shall ensure that any employee using a **tight-fitting facepiece** respirator is fit tested prior to initial use of the respirator, whenever a different respirator facepiece (size, style, model, or make) is used, and at least annually thereafter. The employer shall conduct an additional fit test whenever the employee reports, or the employer, Professionally Licensed Health Care Provider (PLHCP), supervisor, or program administrator makes visual observations of, changes in the employee's physical condition that could affect respirator fit. Such conditions include, but are not limited to: facial scarring, dental changes, cosmetic surgery, or an obvious change in body weight.

The fit test shall be administered using an OSHA-accepted Qualitative Fit Test or Quantitative Fit Test protocol. The OSHA-accepted QLFT and QNFT protocols and procedures are contained in Appendix A of the OSHA standard.

Note: Loose-Fitting Facepieces, Hoods, and Helmets do not require fit testing.

What are the regulations regarding breathing air for supplied air respirators?

Compressed breathing air shall meet at least the requirements for Grade D breathing air described in ANSI/Compressed Gas Association Commodity Specification for Air, G-7.1-1989, to include:

- Oxygen content (v/v) of 19.5-23.5%
- Hydrocarbon (condensed) content of 5 milligrams per cubic meter of air or less
- Carbon monoxide (CO) content of 10 ppm or less
- Carbon dioxide content of 1,000 parts per million (ppm) or less
- Lack of noticeable odor

Compressors used to supply breathing air to respirators are constructed and situated so as to:

- Prevent entry of contaminated air into the air-supply system;
- Minimize moisture content so that the dew point at 1 atmosphere pressure is 10 degrees F (5.56 deg.C) below the ambient temperature;
- Have suitable in-line air-purifying sorbent beds and filters to further ensure breathing air quality. Sorbent beds and filters shall be maintained and replaced or refurbished periodically following the manufacturer's instructions.
- Have a tag containing the most recent change date and the signature of the person authorized by the employer to perform the change. The tag shall be maintained at the compressor.
- For compressors that are not oil-lubricated, the employer shall ensure that carbon monoxide levels in the breathing air do not exceed 10 ppm.
- For oil-lubricated compressors, the employer shall use a high-temperature or carbon monoxide alarm, or both, to monitor carbon monoxide levels. If only high-temperature alarms are used, the air supply shall be monitored at intervals sufficient to prevent carbon monoxide in the breathing air from exceeding 10 ppm.
- The employer shall ensure that breathing air couplings are incompatible with outlets for nonrespirable worksite air or other gas systems. No asphyxiating substance shall be introduced into breathing air lines.

Note: Ambient Air Pumps such as Bullard's Free-Air® Pumps are exempt from CO Monitoring because they are not oil lubricated (OSHA Standards Interpretation July 7, 1994) and Air Sampling (OSHA Standards Interpretation August 13, 1999).

⚠ WARNING: An important warning about the use of replacement parts

NIOSH Respirator Users Notice May 4, 2007:

“...users of NIOSH approved respirators are cautioned against interchanging subassemblies or making unapproved modifications to their respirators. Respirators which have been modified by the interchanging of subassemblies or other deviations using parts not produced and distributed under the respirator manufacturer’s controlled system, no longer meet the definition of being approved as a NIOSH certified respirator...”

This includes, but is not limited to, replacement lenses, blast respirator capes, cool tubes, and air supply hoses.



DEPARTMENT OF HEALTH & HUMAN SERVICES

Public Health Service

Centers for Disease Control
and Prevention (CDC)
National Institute for Occupational
Safety and Health (NIOSH)
National Personal Protective
Technology Laboratory (NPPTL)
P.O. Box 18070
Pittsburgh, PA 15236-0070
Phone: 412-386-4000
Fax: 412-386-4051
May 4, 2007

Respirator Users Notice

Subject: Use of Replacement and Spare Parts

The National Institute for Occupational Safety and Health (NIOSH) issues certificates of approval for specific and complete respirator assemblies after the respirator has been evaluated and found to comply with all the requirements of the NIOSH regulations at Title 42, *Code of Federal Regulations* (CFR) Part 84 (42 CFR Part 84). As part of this evaluation, NIOSH reviews the respirator manufacturer’s quality control plan to determine if it is satisfactory. The respirator manufacturer¹ must address all the components of the respirator in its quality control plan, including those manufactured in-house and those obtained from suppliers. A respirator that includes any replacement or spare part that has not been inspected as part of the respirator manufacturer’s quality control plan is in a configuration not evaluated by NIOSH, and is not NIOSH approved. Please consult the respirator manufacturer before purchasing and installing replacement or spare parts to ensure the NIOSH-approved configuration is maintained.

ADDITIONAL INFORMATION

This is an updated version of a previously-issued (November 6, 1984) Users Notice on the use of unapproved subassemblies. It is being reissued to clarify the interchangeability of respirator subassemblies and unapproved modifications to NIOSH certified (approved) respirators. In some cases even minor modifications to respirators may make significant changes in the performance of the respirator, even if the proposed replacement components or subassemblies (such as self contained breathing apparatus (SCBA) air cylinders or air supply hoses) meet the same component-specific industry safety and performance standards as those included in the NIOSH approval. Respirator manufacturers who modify certified respirators must test the modification to determine if the respirator continues to meet the minimum requirements of 42 CFR Part 84, and must submit the modifications to NIOSH. A user who modifies a certified respirator may not be able to determine whether a change will decrease respiratory protection. Several cases have been reported to NIOSH where unapproved modifications or use of an unapproved subassembly have resulted in respirator failures.

The NIOSH respirator certification regulation, 42 CFR Part 84, defines an approval as “a certificate or formal document issued by the Institute stating that an individual respirator or combination of respirators has met the minimum requirements of this part [84].” Approved is

¹ For the purposes of this notice, the term “respirator manufacturer” means the individual, partnership, company, corporation, association or other organization that holds the NIOSH-issued certificate of approval for a respirator.

Page 2 – Respirator Users Notice

defined to mean that the respirator conforms to the minimum requirements of the regulation. The minimum performance requirements include the applicable construction, performance, manufacturing system quality control and respiratory protection requirements set forth in 42 CFR Part 84. The regulation permits NIOSH to only approve complete respirator assemblies and prohibits the approval of respirator subassemblies such as SCBA air cylinders or supplied air respirator (SAR) air supply hoses. These requirements are intended to insure that one respirator manufacturer has overall control and responsibility for the integrity of the approved respirator. The respirator manufacturer has the responsibility to ensure that its replacement parts are “designed and constructed to ...maintain the effectiveness of the respirator.” 42 CFR 84.62(b).

NIOSH requires the respirator manufacturer to file a quality control plan to assure the quality of the respiratory protection provided by the respirator for which the approval is sought. 42 CFR 84.40. Once approved, that approved quality control plan becomes part of, and is incorporated into, the certificate of approval. Compliance with that plan is a condition of approval. 42 CFR 84.42(c). The issuance of the certificate licenses the respirator manufacturer to use the NIOSH approval label but also obligates that respirator manufacturer “to maintain the approved quality control sampling schedule and the acceptable quality level for each characteristic tested...” 42 CFR 84.33(f).

Therefore, users of NIOSH approved respirators are cautioned against interchanging subassemblies or making unapproved modifications to their respirators. Respirators which have been modified by the interchanging of subassemblies or other deviations using parts not produced and distributed under the respirator manufacturer’s controlled system, no longer meet the definition of being approved as a NIOSH certified respirator and the use of the NIOSH approval label is not authorized for that unit.

Sincerely yours,

Heinz W. Ahlers
Chief, Technology Evaluation Branch
National Personal Protective Technology Laboratory

Respiratory Protection

What are Assigned Protection Factors (APFs)?

Assigned Protection Factor (APF) is the workplace level of respiratory protection that a respirator or class of respirators is expected to provide to employees when the employer implements a continuing, effective respiratory protection program. The APF required for an application can be calculated by dividing the airborne concentration of the contaminant by the PEL for that contaminant. The OSHA-recognized APFs for different types of respirators are found in the table (from 1910.134) below:

TABLE 1.—ASSIGNED PROTECTION FACTORS⁵

Type of respirator ^{1,2}	Quarter mask	Half mask	Full face-piece	Helmet/hood	Loose-fitting facepiece
1. Air-Purifying Respirator	5	³ 10	50
2. Powered Air-Purifying Respirator (PAPR)	50	1,000	⁴ 25/1,000	25
3. Supplied-Air Respirator (SAR) or Airline Respirator					
• Demand mode	10	50
• Continuous flow mode	50	1,000	⁴ 25/1,000	25
• Pressure-demand or other positive-pressure mode	50	1,000
4. Self-Contained Breathing Apparatus (SCBA)					
• Demand mode	10	50	50
• Pressure-demand or other positive-pressure mode (e.g., open/closed circuit)	10,000	10,000

Notes:

¹ Employers may select respirators assigned for use in higher workplace concentrations of a hazardous substance for use at lower concentrations of that substance, or when required respirator use is independent of concentration.

² The assigned protection factors in Table 1 are only effective when the employer implements a continuing, effective respirator program as required by this section (29 CFR 1910.134), including training, fit testing, maintenance, and use requirements.

³ This APF category includes filtering facepieces, and half masks with elastomeric facepieces.

⁴ The employer must have evidence provided by the respirator manufacturer that testing of these respirators demonstrates performance at a level of protection of 1,000 or greater to receive an APF of 1,000. This level of performance can best be demonstrated by performing a WPF or SWPF study or equivalent testing. Absent such testing, all other PAPRs and SARs with helmets/hoods are to be treated as loose-fitting facepiece respirators, and receive an APF of 25.

⁵ These APFs do not apply to respirators used solely for escape. For escape respirators used in association with specific substances covered by 29 CFR 1910 subpart Z, employers must refer to the appropriate substance-specific standards in that subpart. Escape respirators for other IDLH atmospheres are specified by 29 CFR 1910.134 (d)(2)(ii).

*Footnote 4 in essence states that in order to use an APF of 1000, the respirator manufacturer shall provide evidence to the employer that the respirator demonstrates performance at a level of protection equal to or greater than 1000. Bullard has long been a leader in protection factor research. See pages 51 and 92 for the hood and helmet type respirators that have proven APFs of 1,000 and the study that validates it.

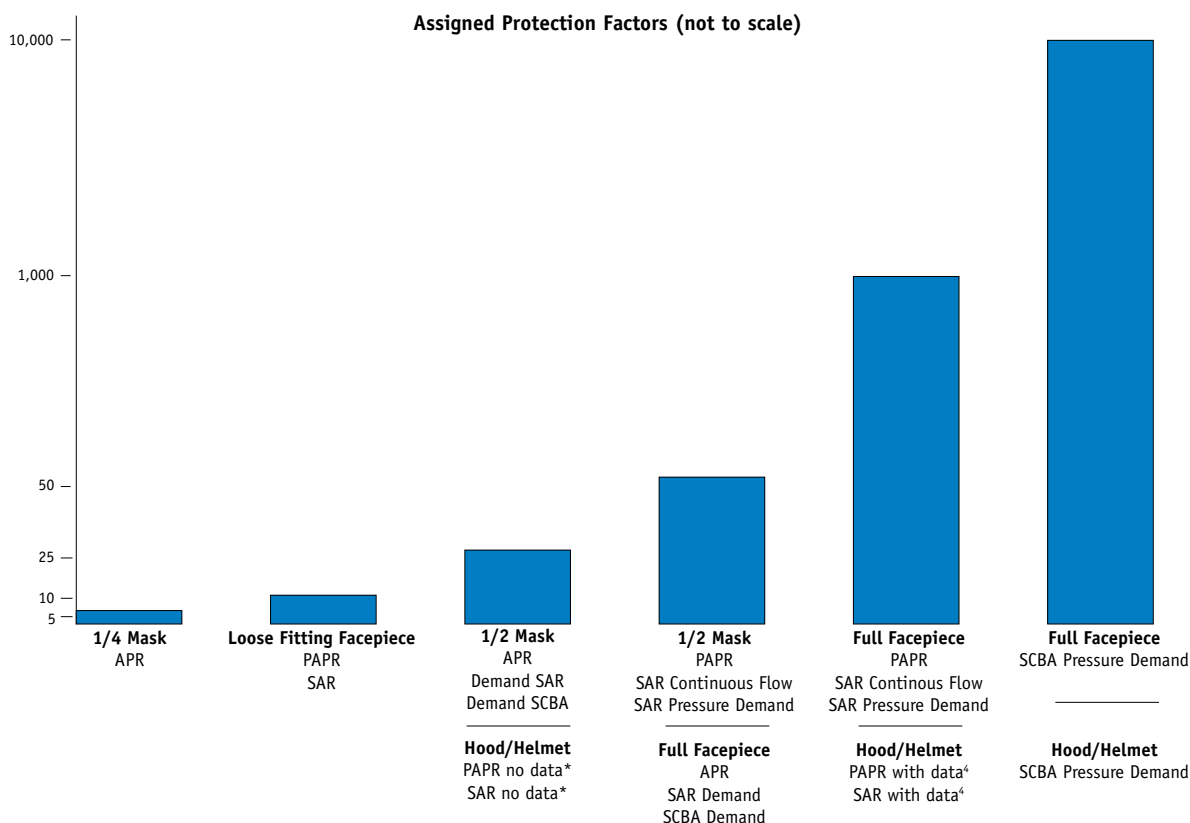

Respiratory Protection

	Bullard Product	Respirator Type	NIOSH TC#	APF	3rd Party Validation
Supplied Air Respirators	Lancer	Type C/CE Helmet	19C-309	1,000	Caldwell 1994
	77 Series	Type C/CE Helmet	19C-84	1,000	LLNL 1995
	88/88VX Series	Type C/CE Helmet	19C-293	1,000	LLNL 1995
	GenVX™ Series	Type C/CE Helmet	19C-0489 19C-0491 19C-0492 19C-0493 19C-0494 19C-0495 19C-0496	1,000	RDECOM 2012
	GR50 Series*	Type C Hood	19C-329	1,000	RDECOM 2012
	CC20 Series*	Type C Hood	19C-154	1,000	ORC 1997
	RT Series	Type C Hood	19C-412	1,000	RDECOM 2007
	PC90 Series	Type C Hood/Suit	19C-280	1,000	Caldwell 1994
	FAMB Series	Type C ½ Mask	19C-469	50	OSHA Final APF Rule 2006
	Spectrum® Series	Type C Full Facepiece	19C-321 19C-322 19C-354 19C-387 19C-388	1,000	OSHA Final APF Rule 2006
Powered Air Purifying Respirators (PAPRs)	PA20 CC20 Series	LF/Hood	21C-0765	25	OSHA Final APF Rule 2006
	PA30 CC20 Series*	Hood	21C-0773 23C-2236 23C-2237	1,000	RDECOM 2003
	PA30 RT Series	Hood	21C-0773 23C-2236 23C-2237	1,000	RDECOM 2004
	PA40 Spectrum®	Full Facepiece	21C-0774	1,000	OSHA Final APF Rule 2006
	PA30IS CC20 Series*	Hood	21C-0796 23C-2306 23C-2307	1,000	RDECOM 2006
	PA30IS RT Series	Hood	21C-0796 23C-2306 23C-2307	1,000	RDECOM 2006
	EVA CC20 Series*	Hood	21C-0836 23C-2510	1,000	RDECOM
	EVA RT Series	Hood	21C-0836 23C-2510	1,000	RDECOM
	EVA FAMB	½ Mask	21C-0486 23C-2511	50	OSHA Final APF Rule 2006
	EVA Spectrum®	Full Facepiece	21C-0844 23C-2512	1,000	OSHA Final APF Rule 2006
	EVAHL CC20 Series*	Hood	21C-0922 23C-2765	1,000	RDECOM 2012
	EVAHL RT Series	Hood	21C-0922 23C-2765	1,000	RDECOM 2012

* Double Bib Models only

Powered Air-Purifying Respirators (PAPRs)



What is a Powered Air-Purifying Respirator?

Powered Air-Purifying Respirators (PAPRs) use a battery-powered fan to draw in ambient air through filter cartridges. The purified air is then delivered to the user's hood, helmet, or facepiece via a breathing tube. A flow indicator is provided to check that there is an adequate volume of air available to the wearer prior to use. There are many different PAPR configurations available to best meet the needs of your working environment.

Configuring a Powered Air-Purifying Respirator System

There are many choices to make when piecing together components of a Powered Air-Purifying Respirator System. The following steps may help simplify this intimidating task:

- Choose Blower
- Choose Belt
- Choose Head Top with threaded T-Series or Clamp style connection
- Choose Suspension or Hard Hat (if applicable)
- Choose Breathing Tube
- Choose Filter/Cartridge
- Choose Charger
- Choose Accessories

Bullard PAPRs Provide Maximum Airflow Throughout the Entire Shift

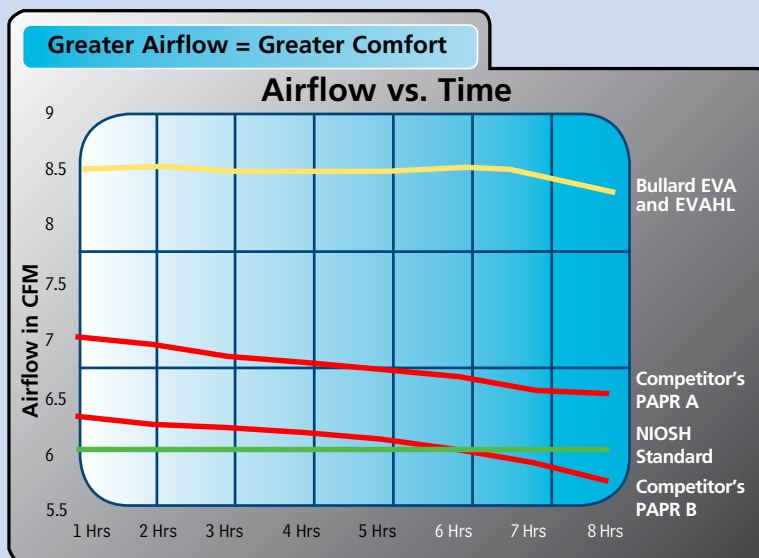

Powered Air Purifying Respirators (PAPRs)

PAPR Selection Chart

1. Choose Blower



• EVA



• EVAHL

2. Choose Belt



• EVABELT1 - Comfort Decon
• EVAEB - Vinyl extension



• EVABELT2 - Vinyl Decon
• EVAEB - Vinyl extension

3. Choose Head Top



• 20TJN - Tychem® QC Single Bib
• 20TPN - With Solvent-Resistant Lens
• 20TJNT - Tychem® QC Single Bib, Threaded
• 20TPNT - With Solvent-Resistant Lens, Threaded

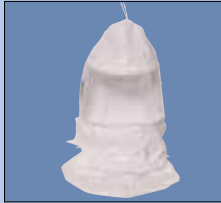

• 20TICN - Tychem® QC Double Bib
• 20TPCN - With Solvent-Resistant Lens
• 20TICNT - Tychem® QC Double Bib, Threaded
• 20TPCNT - With Solvent-Resistant Lens, Threaded



• 20SICN - Tychem® SL Double Bib w/Taped Seams
• 20TICSN - Tychem® QC Double Bib w/Taped Seams
• 20SICNT - Tychem® SL Double Bib w/Taped Seams, Threaded
• 20TICSNT - Tychem® QC Double Bib w/Taped Seams, Threaded



• 20SICH - Tychem® SL Double Bib with Taped Seams for Hard Hats
• 20TICH - Tychem® QC Double Bib for Hard Hats
• 20SICHT - Tychem® SL Double Bib with Taped Seams for Hard Hats, Threaded
• 20TICHT - Tychem® QC Double Bib for Hard Hats, Threaded



• 20LFM - Loose-Fitting Facepiece, Medium
• 20LFL - Loose-Fitting Facepiece, Large
• 20LF2S, 20LF2M, 20LF2L - Narrow Version



• RT1 - Tychem® QC Double Bib Hood
• RT2 - Tychem® SL (Saranex coated) Double Bib Hood with Taped Seams
• RT1T - Tychem® QC Double Bib Hood, Threaded
• RT2T - Tychem® SL (Saranex coated) Double Bib Hood with Taped Seams, Threaded



• RT3 - Tychem® QC Double Bib with Extra-Large Lens
• RT4 - Tychem® SL Saranex Coated Double Bib with Extra-Large Lens and Taped Seams
• RT3T - Tychem® QC Double Bib with Extra-Large Lens*, Threaded
• RT4T - Tychem® SL Saranex Coated Double Bib with Extra-Large Lens and Taped Seams*, Threaded



• GRH Nomex Grinding Hood for EVA
• GRHT



• PASPECML, PASPECS - Full-Facepiece, for EVA



• FAMB2L, FAMB2M, FAMB2S - Half-Mask, for EVA

4. Choose Suspension or Hard Hat (Not required for masks)



• 20RT - Adjustable Flex-Gear® Ratchet Headband Suspension for All Heads



• C30R - With 6-point Flex-Gear® Ratchet Suspension for 20SICH, 20TICH, GRH



• S51R - With 4-point Flex-Gear® Ratchet Suspension for 20SICH, 20TICH, GRH

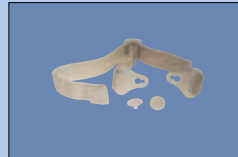

• 20NC - Chinstrap, for Hoods

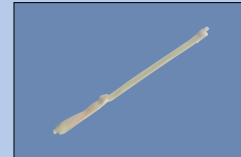

• ES42 - Chinstrap, for Hard Hats

5. Choose Breathing Tube



• PA1BT - 26" for Hoods
• PA1BTXS - 22" for Hoods
• PA1BTXL - 32" for Hoods
• PAHBT - 26" Threaded
• PAHBTXS - 22" Threaded
• PAHBTXL - 32" Threaded



• PA20LFBT - 32" for 20LF
• PA20LFBXS - 26" for 20LF
• PA20LFBTSL - 38" for 20LF



• PA4BT - 33" for PASPEC



• PAFAMBT for FAMB

6. Choose Filter Cartridge and Accessories

For EVA and EVAHL



PAPRPCOVER2 - Pre-Filter Cover/Retainer 3 Per Pack



PAPRPF2 - Pre-Filter for EVA



PAPRFC3 - HE



PAPRFC4 - OV/AG/HE



PAPRSC2 - Decon Shower Cap for EVA HE



PAPRSC3 - Shower Cap for EVA OV/AG/HE

PAPRFC5 - EVA ONLY - AM/FM/CL/HC/MA/SD/CD/HF/HE

7. Choose Charger



• EVASC - Smart Charger, Single Port
• EVASC2 - Smart Charger, Single Port
• EVAHSMC - Smart Charger, Single Port
• EVAHSMC2 - Smart Charger, Single Port



• EVAGC - Gang Charger, 6 Port
• EVAHLCG - Gang Charger, 6 Port



EVA Powered Air-Purifying Respirator

Reliable, Easy-To-Use Technology

EVA was uniquely designed for all-day worker comfort. Engineers studied the motions, actions, and requests from experts in the field to design the most comfortable and user-friendly PAPR on the market.

Visual Fuel Gauge



The easy to read fuel gauge displays remaining battery capacity at a glance. Wearers can check battery status at any time while using EVA.

Active Flow Technology

Another innovation from Bullard, Active Flow Technology automatically responds to a worker's need for more or less air flow. This intelligent system is continuously working to maintain constant air flow, regardless of filter type, hood type, filter loading, or battery capacity.

Integrated Alarms

Two distinct audible alarms notify wearers of low battery and low air flow. These alarms are designed so the sound of the alarm travels through the breathing tube directly to the wearer's ear.

Durability

EVA is powered by a long-lasting 10,000-hour brushless motor. Unlike other motors that can quickly wear out, this durable brushless motor is designed for long-term reliable use.

Single Filter Design

EVA offers a single filter design for easy use. While other manufacturers' PAPRs may require up to three combination filters, EVA makes it simple, with a single easy-to-install filter.

Filter Locking Tab



EVA helps ensure positive filter installation with a single click. The filter locking tab notifies the user that the filter is in place with both a visual indication and audible click.

Distinctive Ergonomic Design



The streamlined form factor of EVA makes it lightweight, eliminates bulky corners that can dig into the wearer's back, and balances the unit's weight for maximum comfort.

EVA Series Powered Air-Purifying Respirator

EVA Systems

A NIOSH approved EVA Powered Air Purifying Respirator System consists of four components:

- (1) Hood or Mask
- (2) Breathing Tube
- (3) Blower Assembly
- (4) Purifying Filter Cartridge



Approval No. 21C-0836 Hoods, HE filter
 23C-2510 Hoods, OVAG filter
 21C-0844 Spectrum®, HE
 23C-2512 Spectrum®, HE, OVAGHE
 21C-0846 FAMB, HE
 23C-2511 FAMB, OVAGHE

EVA Series Assemblies

Pandemic Preparedness Systems

- Assemblies include blower with filter, belt, battery, air flow indicator, breathing tube, head top

- EVAPAN1** PAPR System with 20LF2L loose-fitting facepiece, HE Filter, Single Charger
- EVAPAN2** PAPR System with 20LF2L loose-fitting facepiece, HE Filter, No Charger



EVAPAN1

PAPRs with Loose-Fitting Facepieces

- Assemblies include blower, belt, battery, charger, air flow indicator, breathing tube, head top with suspension (Filter not included)
- PAPR System with loose-fitting facepiece

- EVA20LFL** with 20LFL loose-fitting facepiece
- EVA20LFM** with 20LFM loose-fitting facepiece
- EVA20LF2L** with 20LF2L loose-fitting facepiece
- EVA20LF2M** with 20LF2M loose-fitting facepiece
- EVA20LF2S** with 20LF2S loose-fitting facepiece

*Add DB suffix for decon belt



EVA20LFL

EVA Series Powered Air-Purifying Respirator

EVA Systems

PAPRs with Single Bib Hoods

- Assemblies include blower, belt, battery, breathing tube, charger, air flow indicator, and head top (filter not included)
- PAPR system with hood

EVA20TJ	with 20TJ hood (acetate lens)
EVA20TP	with 20TP hood (polyester lens)
EVA20TJT	with 20TJ Quick-Attach T-Series hood
EVA20TPT	with 20TP Quick-Attach T-Series hood

*Add DB suffix for decon belt



20TJ hood

PAPRs with Double Bib Tychem® QC Hoods

- Assemblies include blower, belt, battery, charger, air flow indicator, breathing tube, head top, and ratchet suspension (filter not included)
- PAPR system with hood

EVA20TIC	with 20TIC hood (acetate lens)
EVA20TPC	with 20TPC hood (polyester lens)
EVA20TICS	with 20TICS hood (acetate lens long outer bib, taped seams)
EVART1	with RT1 hood (oversized acetate lens and inflatable neck cuff)
EVART3	with RT3 hood (oversized acetate lens and no headband)
EVA20TICT	with 20TICT Quick-Attach T-Series hood (acetate lens)
EVA20TPCT	with 20TPCT Quick-Attach T-Series hood (polyester lens)
EVA20TICST	with 20TICST Quick-Attach T-Series hood (acetate lens long outer bib, taped seams)
EVART1T	with RT1T Quick-Attach T-Series hood (oversized acetate lens and inflatable neck cuff)
EVART3T	with RT3T Quick-Attach T-Series hood (oversized acetate lens and no headband)

*Add DB suffix for decon belt



20TIC hood

Best Seller

PAPRs with Double Bib Hoods and Head Protection

- Assemblies include blower, belt, battery, charger, air flow indicator, breathing tube, head top, and S51R hard hat (filter not included)
- PAPR system with hood

EVA20TICH	with 20TICH hood (Tychem® QC and acetate lens)
EVA20SICH	with 20TPC hood (Tychem® SL and acetate lens)
EVA20TICHT	with 20TICH Quick-Attach T-Series hood (Tychem® QC and acetate lens)
EVA20SICHT	with 20TPC Quick-Attach T-Series hood (Tychem® SL and acetate lens)

*Add DB suffix for decon belt



EVA20TICH hood



EVA Series Powered Air-Purifying Respirator

EVA Series Assemblies

PAPRs with Double Bib Tychem® SL Hoods (Saranex Coated)

- Assemblies include blower, belt, battery, charger, air flow indicator, breathing tube, head top, and ratchet suspension (filter not included)

- EVA20SIC** with 20SICR hood (acetate lens and taped seams)
- EVART2** with RT2 hood (oversized acetate lens and inflatable neck cuff)
EVART4 with RT4 hood (oversized acetate lens and no headband)
- EVA20SICT** with 20SICR Quick-Attach T-Series hood (acetate lens and taped seams)
- EVART2T** with RT2 Quick-Attach T-Series hood (oversized acetate lens and inflatable neck cuff)
EVART4T with RT4 Quick-Attach T-Series hood (oversized acetate lens and no headband)



*Add DB suffix for decon belt

PAPRs with Double Bib Nomex Grinding Hoods

- Assemblies include blower, belt, battery, charger, air flow indicator, breathing tube, head top, and ratchet suspension (filter not included)

- EVAGRH** with GRHRT hood (acetate inner lens, detachable outer lens)
- EVAGRHT** with GRHRT Quick-Attach T-Series hood (acetate inner lens, detachable outer lens)



*Add DB suffix for decon belt

PAPRs with Full-Face Masks

- Assemblies include blower, belt, battery, charger, air flow indicator, breathing tube, and mask (filter not included)

- EVASPECL** with Med/Large Spectrum® Full-Face Mask
EVASPECS with Small Spectrum® Full-Face Mask



*Add DB suffix for decon belt

PAPRs with Half-Face Masks

- Assemblies include blower, belt, battery, charger, air flow indicator, breathing tube and mask (filter not included)

- EVAFAML** with Large FAM2L Half-Face Mask
EVAFAMM with Medium FAM2M Half-Face Mask
EVAFAMS with Small FAM2S Half-Face Mask



*Add DB suffix for decon belt

EVA Series Powered Air-Purifying Respirator

EVA Series Replacement Blowers

EVA1	Blower Unit only
EVA2	Blower, Belt, EVABAT1 Battery, Charger
EVA3	Blower, Belt, EVABAT1 Battery
EVA4	Blower, Belt, EVABAT1 Battery, HE Filter
EVA5	Same as EVA2 w/ EVABAT2 Battery
EVA6	Same as EVA3 w/ EVABAT2 Battery
EVA7	Same as EVA4 w/ EVABAT2 Battery



EVA4

EVA Series Replacement Filters and Cartridges

PAPRFC3	HE Filter (6 per package)
PAPRFC4	OV/AG/HE Filter - Organic Vapors, Chlorine, Chlorine Dioxide, Sulfur Dioxide, Hydrogen Chloride, Hydrogen Fluoride, and High Efficiency Particulate (6 per package)
PAPRFC5	Ammonia, Formaldehyde, Chlorine, Chlorine Dioxide, Sulfur Dioxide, Hydrogen Chloride, Hydrogen Fluoride, Methylamine, High Efficiency Particulate
PAPRFC4ICP	Filter storage cap (3 pack), PAPRFC4 Inlet
PAPRFC4OCP	Filter storage cap (3 pack), PAPRFC3/PAPRFC4 Outlet



MAXXLife Calculator

The ultimate tool for calculating respirator cartridge protection

MAXXLife is a user-friendly calculator that helps measure the service life of air-purifying respirator cartridges from Bullard. MAXXLife lets you manage the life of your cartridge. Just follow the step-by-step MAXXLife Calculator program to determine how long you can use your cartridge before it needs to be replaced.

Download it at www.bullard.com



EVA Series Batteries

EVABAT1	Battery (black) for use with hoods
EVABAT2	Battery (green) for use with masks



EVABAT1

EVABAT2

EVA Series Chargers

EVASMC	Charger, Single Port
EVASMC2 (AKA "The EVALuator")	Charger, Single Port Analyzer



EVASMC

EVASMC2

EVASMCPS	Power Supply, EVASMC, EVASMC2, EVAHLSMC, EVAHLSMC2
-----------------	--

EVASMC AU	EVASMC for Australia
EVASMC EU	EVASMC for Europe
EVASMC UK	EVASMC for United Kingdom



EVASMC AU

EVASMC EU

EVASMC UK



EVAGC	Charger, Six Port Gang, 16x13x4
--------------	---------------------------------



EVAGC

EVA Series Powered Air-Purifying Respirator

EVA Series Replacement Parts and Accessories

EVABELT1	Belt, closed cell, chemically resistant, combination comfort, and decon		EVABELT1
EVABELT2	Belt, closed cell, chemically resistant, vinyl decon		EVABELT2
EVAEXT1	Extender belt		EVAEXT1

PAPRSUSP1	Suspenders, vinyl		PAPRSUSP1
EVALLKIT	Lever Lock Kit for EVA Back Plate		
PAPRSC2	Decon Shower Cap for EVA HE		
PAPRSC3	Decon Shower Cap for EVA OV/AG/HE		
PAPRPF2	Pre-Filter (120 pk) for EVA OV/AG/HE		
PAPRPFCOVER2	Pre-Filter Cover for EVA OV/AG/HE		
EVABP1	Back Plate for EVABELT1		
EVABP2	Back plate for EVABELT2		
EVABUCKLE	Buckle for EVA		
EVACAPBLK	Vinyl Storage Cap Black (3 pk)		
EVACAPRED	Vinyl Storage Cap Red (3 pk)		



EVABUCKLE



EVALLKIT



PAPRSC2



PAPRSC3



PAPRPFCOVER2

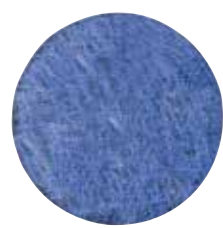

PAPRPF2



EVABP1



EVABP2



EVACAPBLK

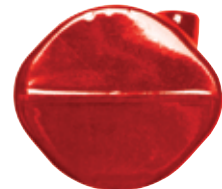

EVACAPRED

EVA Dust Covers

EVADCQC1	Dust cover, Tychem® QC for PAPRFC3
EVADCQC2	Dust cover, Tychem® QC for PAPRFC4
EVADCFK1	Dust cover, FR for PAPRFC3
EVADCFK2	Dust cover, FR for PAPRFC4

Guidance for Powered Air-Purifying Respirators (PAPRs) Used in Hazardous Classified Locations

PAPRs are often used in Hazardous Classified Locations, so it is important to understand the regulatory and practical implications. This document provides a brief overview of Hazardous Locations (HazLoc) in general, as well as some specifics with regards to PAPRs.

Overview

A Hazardous Classified Location is an area where fire or explosion hazards exist due to flammable gases or vapors, flammable liquids, combustible dust, or ignitable fibers or flyings.

- Classes: Classes define an area with respect to type of hazard presiding in the area.
- Divisions: Divisions further define an area with respect to whether potentially explosive conditions reside normally or abnormally.
- Groups: Groups further define Class I and Class II areas by the nature of the flammable substances.

Temperature Codes

Because mixtures of hazardous gases and air may ignite in contact with a hot surface, equipment that is certified for hazardous locations receive a temperature code indicating the maximum surface temperature of the equipment. These range from a T6 rating of 185 F° to a T1 rating of 842 F°. Below is a summary from the National Electric Code (NEC) Articles 501-503 and referenced in OSHA's Hazardous Classified Locations Outreach Training for the Construction Industry.

Summary of Class I, II, III Hazardous Locations				
Class	Group	Division		
		1	2	
I	Gases, Vapors, Liquids Examples include: Petroleum refineries, spray finishing area, and pharmaceutical manufacturing plants.	A. Acetylene B. Atmospheres such as butadiene, ethylene oxide, propylene oxide, acrolein, or hydrogen (or gases or vapors equivalent in hazard to hydrogen) C. Atmospheres such as cyclopropane, ethyl ether, ethylene, or gas or vapors of equivalent hazard D. Atmospheres such as acetone, alcohol, ammonia, benzene, benzol, butane, gasoline, hexane, lacquer solvent vapors, naphtha, natural gas, propane, or gas or vapors of equivalent hazard	Normally explosive and hazardous	Not normally present in an explosive concentration (but may accidentally exist).
II	Dust Examples include: Grain elevators, flour mills, coal preparation plants, and pharmaceutical manufacturing plants.	E. Metal Dust. Aluminum and magnesium dust and other metal dusts of similar nature. F. Atmospheres containing such materials as carbon black, charcoal dust, coal, and coke dust. G. Grain dust, flour, starch, cocoa, and similar types of materials.	Ignitable quantities of dust normally are or may be in suspension, or conductive dust may be present.	Dust not normally suspended in an ignitable concentration (but may accidentally exist). Dust layers are present.
III	Fibers and Flyings Examples include: Textile mills, cotton gins, and saw mills.	H. Textiles, woodworking, etc (easily ignitable, but not likely to be explosive)	Handled or used in manufacturing.	Stored or handled in storage (exclusive of manufacturing).

From OSHA 1910.399 Class I locations. Class I locations are those in which flammable gases or vapors are or may be present in the air in quantities sufficient to produce explosive or ignitable mixtures. Class I locations include the following:

(1) A Class I, Division 1 location is a location:

- (i) In which ignitable concentrations of flammable gases or vapors may exist under normal operating conditions; or
- (ii) In which ignitable concentrations of such gases or vapors may exist frequently because of repair or maintenance operations or because of leakage; or
- (iii) In which breakdown or faulty operation of equipment or processes might release ignitable concentrations of flammable gases or vapors, **and** might also cause simultaneous failure of electric equipment.

(2) A Class I, Division 2 location is a location:

- (i) In which volatile flammable liquids or flammable gases are handled, processed, or used, but in which the hazardous liquids, vapors, or gases will normally be confined within closed containers or closed systems from which they can escape only in the event of accidental rupture or breakdown of such containers or systems, or as a result of abnormal operation of equipment; or
- (ii) In which ignitable concentrations of gases or vapors are normally prevented by positive mechanical ventilation, and which might become hazardous through failure or abnormal operations of the ventilating equipment; or
- (iii) That is adjacent to a Class I, Division 1 location, and to which ignitable concentrations of gases or vapors might occasionally be communicated unless such communication is prevented by adequate positive-pressure ventilation from a source of clean air, and effective safeguards against ventilation failure are provided.

Guidance for Powered Air-Purifying Respirators (PAPRs) Used in Hazardous Classified Locations

Note to the definition of “Class I, Division 2:” This classification usually includes locations where volatile flammable liquids or flammable gases or vapors are used, but which would become hazardous only in the case of an accident or from some unusual operating condition. The quantity of flammable material that might escape in case of an accident, the adequacy of ventilating equipment, the total area involved, and the record of the industry or business with respect to explosions or fires are all factors that merit consideration in determining the classification and extent of each location.

HazLoc Equipment

Equipment used in HazLoc areas are designed with the prevention of a fire or explosion in mind. There are three ingredients necessary for a fire or explosion: a flammable material (such as the gas, vapor, or dust), an oxidizer (like air or oxygen), and an ignition source (such as a spark or high heat). Equipment designers employ a variety of techniques to prevent their equipment from being an ignition source, from coming in contact with flammable materials, and from coming in contact with oxidizers that can fuel a fire. Enclosures can be designed so that the flammable material stays outside the enclosure, any sparks stay inside the enclosure, and only a limited supply of air (oxidizer) exists within the enclosure. Materials are selected so that a spark isn't generated from friction or impact. Circuits are designed so that electrical sparks are minimized. Further considerations result in designs that limit the temperature rise of the equipment to prevent surface ignition which can occur at the Auto-Ignition Temperature (ATI) or spontaneous ignition temperature at which a hazardous substance will spontaneously ignite without further energy. Finally, design techniques can be taken to limit energy. These protective techniques have names that include explosion proof, dust ignition-proof, dust tight, nonincendive, and intrinsic safety.

PAPR Specifics:

PAPRs are typically designed with one of two protective design techniques: nonincendive or intrinsic safety. According to the Fire Protection Handbook, intrinsically safe is defined as "...equipment and wiring incapable of releasing sufficient energy under normal or abnormal conditions to cause ignition of a specific hazardous atmospheric mixture." This protective technique can receive certification for Division 1 environments. Nonincendive equipment is incapable, under normal operating conditions, of causing ignition of a specified flammable gas-air, vapor-air, or dust-air mixture due to arcing or thermal means. This protective technique can receive certification for Division 2 environments.

Certification

There are several factors that determine the type of certification a piece of electrical equipment will receive. For a battery powered device such as a PAPR, the amount of energy in the battery, the operational voltage, the location of battery contacts and the inductance of the motor are all factors. PAPR users often desire features in the blower unit that make achieving the highest hazardous classified location certifications difficult. Higher airflow and longer battery run time require higher levels of energy. Removable batteries, for sharing a blower across shifts, make battery contact design very challenging. At the end of the day the designers must balance the features requested by the customers with the limitations imposed by the certification standards. The implication is that the higher the performance of the PAPR, the less likely the PAPR will be designed with the intrinsic safety protective technique.

Bullard HazLoc PAPRs:

Bullard has (1) HazLoc PAPRs:

1. The EVAHL which is certified by CSA for Class I, Div 2, Groups A, B, C, D; Class II, Div 2, Groups F, G; Class III

Key Points to Remember

- Equipment used in any Hazardous Classified Location must match the classification of the location.
- The presence of a flammable substance is not the sole criteria to determine Division 1 or Division 2 designation (see 1910.399).
 - The **concentration** level of the gas/vapor is a key determining factor.
 - The simultaneous failure of electrical equipment is key if the abnormal release of an ignitable concentration is being considered.

Key References

Underwriters Laboratory (UL) North American Protective Techniques Comparison

http://www.ul.com/global/documents/offerings/services/hazardouslocations/CI_protection_methods.pdf

Factory Mutual (FM) Hazardous Locations Resources

<http://www.fmglobal.com/page.aspx?id=50010107>

Canadian Standards Association (CSA) HazLoc Certification in North America

http://www.csa-international.org/product_areas/hazloc equip/hazloc_for_north_america/

OSHA's Hazardous Classified Locations Outreach Training

<http://www.osha.gov/doc/outreachtraining/htmlfiles/hazloc.html>

Key Regulations

OSHA 29 CFR 1910.399 Subpart S Electrical, Definitions

http://www.osha.gov/pls/oshaweb/owadisp.show_document?p_table=STANDARDS&p_id=9976

OSHA 29 CFR 1910.307 Subpart S Electrical, Hazardous (Classified) Locations

http://www.osha.gov/pls/oshaweb/owadisp.show_document?p_id=9884&p_table=standards

OSHA 29 CFR 1910.134 Subpart I Personal Protection Equipment, Respiratory Protection

http://www.osha.gov/pls/oshaweb/owadisp.show_document?p_table=standards&p_id=12716

EVAHL Powered Air-Purifying Respirator

For Hazardous Locations

Combining the cutting-edge technology and ergonomic design of the EVA, the EVAHL Powered Air-Purifying Respirator (PAPR) offers workers greater protection in Hazardous Locations. The EVAHL is NIOSH approved and certified by CSA International for Hazardous Locations Class I, Division 2, Groups A, B, C, D, T6; Class II, Division 2 Groups F, G; and Class III.

All the Great EVA Features...

Now HazLoc Rated

With a HazLoc rating, EVAHL can be used in multiple hazardous locations which may exist due to flammable gases or vapors, flammable liquids, combustible dust, or ignitable fibers or flyings. Equipped with an ergonomic single-filter design, dual speeds, two alarms, and a visual fuel gauge, EVAHL offers advanced technology in a compact, streamlined design.

Safe and Dependable

EVAHL is equipped with an Active Flow Technology system that automatically maintains constant air flow regardless of filter type, hood type, filter loading, or battery capacity. Designed for worker safety, EVAHL features dual alarms for low air flow and low battery and a filter locking tab that notifies users that the filter is properly in place. Its 10,000-hour brushless motor is designed for long-term reliable use providing 10 times the life of most brush motors.

EVAHL can be used with Bullard Dupont™ Tychem® hoods and loose-fitting facepieces. Bullard hoods, rated highest in the industry, provide superior protection with a 1,000 Assigned Protection Factor (APF) that is documented by an independent third party.



EVAHL Series Powered Air-Purifying Respirator

EVAHL Systems

(NIOSH Approval #s 21C-0922, 23C-2765)

A complete EVAHL Series Respirator consists of the following four components:

- (1) Respirator Headtop (Hood or Loose-Fitting Facepiece)
- (2) Breathing Tube Assembly
- (3) EVAHL1 Blower Unit Assembly with Belt
- (4) Purifying Filter Cartridge

All of these components must be present and properly assembled to constitute a NIOSH approved respirator.

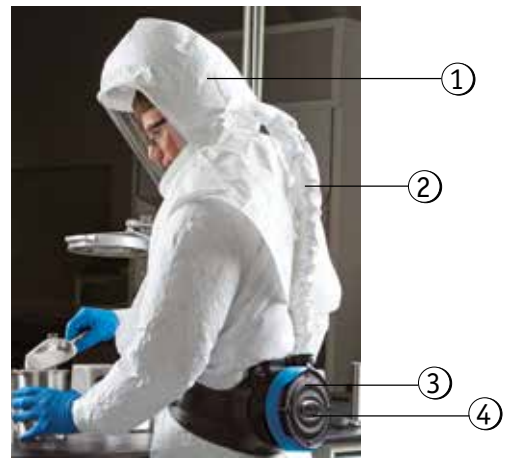

EVAHL Series Assemblies

Pandemic Preparedness Assemblies

- Assemblies include blower, belt, battery, air flow indicator, breathing tube, headtop, and charger. (Filter sold separately)

- EVAHLPAN1** PAPR System with 20LF2L loose-fitting facepiece, HE Filter, Single Charger
- EVAHLPAN2** PAPR System with 20LF2L loose-fitting facepiece, HE Filter, No Charger



EVAHLPAN1

PAPRs with Loose-Fitting Facepieces

- Assemblies include blower, belt, battery, charger, air flow indicator, breathing tube, head top with suspension. (Filter sold separately)
- PAPR System with loose-fitting facepiece

- EVAHL20LFL** with 20LFL loose-fitting facepiece
- EVAHL20LFM** with 20LFM loose-fitting facepiece

- EVAHL20LF2L** with 20LF2L loose-fitting facepiece
- EVAHL20LF2M** with 20LF2M loose-fitting facepiece
- EVAHL20LF2S** with 20LF2S loose-fitting facepiece



EVAHL20LFL

*Add DB suffix for decon belt

EVAHL Series Powered Air-Purifying Respirator

EVAHL Systems

PAPRs with Single Bib Hoods

- Assemblies include blower, belt, battery, breathing tube, charger, air flow indicator, and head top. (Filter sold separately)
- PAPR system with hood

EVAHL20TJ	with 20TJ hood (acetate lens)
EVAHL20TP	with 20TP hood (polyester lens)
EVAHL20TJT	with 20TJ Quick-Attach T-Series hood
EVAHL20TPT	with 20TP Quick-Attach T-Series hood

*Add DB suffix for decon belt



EVAHL20TJ

PAPRs with Double Bib Tychem® QC Hoods

- Assemblies include blower, belt, battery, charger, air flow indicator, breathing tube, head top and ratchet suspension. (Filter sold separately)
- PAPR system with hood

EVAHL20TIC	with 20TIC hood (acetate lens)
EVAHL20TPC	with 20TPC hood (polyester lens)
EVAHL20TICS	with 20TICS hood (acetate lens long outer bib, taped seams)
EVAHLRT3	with RT3 hood (oversized acetate lens and no headband)
EVAHL20TICT	with 20TICT Quick-Attach T-Series hood (acetate lens)
EVAHL20TPCT	with 20TPCT Quick-Attach T-Series hood (polyester lens)
EVAHL20TICST	with 20TICST Quick-Attach T-Series hood (acetate lens long outer bib, taped seams)
EVAHLRT3T	with RT3T Quick-Attach T-Series hood (oversized acetate lens and no headband)

*Add DB suffix for decon belt



EVAHL20TIC

PAPRs with Double Bib Hoods and Head Protection

- Assemblies include blower, belt, battery, charger, air flow indicator, breathing tube, head top and S51R hard hat. (Filter sold separately)

EVAHL20TICH	with 20TICH hood (Tychem® QC and acetate lens)
EVAHL20SICH	with 20SICH hood (Tychem® SL and acetate lens)
EVAHL20TICHT	with 20TICH Quick-Attach T-Series hood (Tychem® QC and acetate lens)
EVAHL20SICHT	with 20SICH Quick-Attach T-Series hood (Tychem® SL and acetate lens)

*Add DB suffix for decon belt



EVAHL20TICH



EVAHL Series Powered Air-Purifying Respirator

EVAHL Series Assemblies

PAPRs with Double Bib Tychem® SL Hoods

- Assemblies include blower, belt, battery, charger, air flow indicator, breathing tube, head top and ratchet suspension. (Filter sold separately)

EVAHL20SIC with 20SICR hood (acetate lens and taped seams)

EVAHLRT4 with RT4 hood (oversized acetate lens and no headband)

EVAHL20SICT with 20SICT Quick-Attach T-Series hood (acetate lens and taped seams)

EVAHLRT4T with RT4 Quick-Attach T-Series hood (oversized acetate lens and no headband)

*Add DB suffix for decon belt



EVAHL Series Powered Air-Purifying Respirator

EVAHL Series Replacement Blowers

EVAHL1	Blower Unit only
EVAHL2	Blower, Belt, EVABAT1 Battery, Charger
EVAHL3	Blower, Belt, EVABAT1 Battery
EVAHL4	Blower, Belt, EVABAT1 Battery, HE Filter
EVAHL5	Same as EVA2 w/ EVABAT2 Battery
EVAHL6	Same as EVA3 w/ EVABAT2 Battery
EVAHL7	Same as EVA4 w/ EVABAT2 Battery



EVAHL4



EVA Series Replacement Filters and Cartridges

PAPRFC3	HE Filter (6 per package)
PAPRFC4	OV/AG/HE Filter - Organic Vapors, Chlorine, Chlorine Dioxide, Sulfur Dioxide, Hydrogen Chloride, Hydrogen Fluoride, and High Efficiency Particulate (6 per package)



PAPRFC4ICP	Filter storage cap (3 pack), PAPRFC4 Inlet
PAPRFC4OCP	Filter storage cap (3 pack), PAPRFC3/PAPRFC4 Outlet



MAXXLife Calculator

The ultimate tool for calculating respirator cartridge protection

MAXXLife is a user-friendly calculator that helps measure the service life of air-purifying respirator cartridges from Bullard. MAXXLife lets you manage the life of your cartridge. Just follow the step-by-step MAXXLife Calculator program to determine how long you can use your cartridge before it needs to be replaced.

Download it at www.bullard.com



EVA Series Batteries

EVABAT1	Battery (black) for use with hoods
----------------	------------------------------------



EVABAT1

EVA Series Chargers

EVAHLSMC	Charger, Single Port
EVAHLSMC2 (AKA "The EVAuator")	Charger, Single Port Analyzer



EVAHLSMC



EVAHLSMC2

EVAHLSMCPS	Power Supply, EVASMC, EVASMC2, EVAHLSMC, EVAHLSMC2
-------------------	--

EVAHLSMCAU	EVASMC for Australia
EVAHLSMCEU	EVASMC for Europe
EVAHLSMCKUK	EVASMC for United Kingdom



EVAHLSMCAU



EVAHLSMCEU



EVAHLSMCKUK



EVAHLGC	Charger, Six Port Gang, 16x13x4
----------------	---------------------------------





EVAHLGC

EVAHL Series Powered Air-Purifying Respirator

EVAHL Series Replacement Parts and Accessories

EVABELT1	Belt, closed cell, chemically resistant, combination comfort, and decon		EVABELT1
EVABELT2	Belt, closed cell, chemically resistant, vinyl decon		EVABELT2
EVAEXT1	Extender belt		EVAEXT1

PAPRSUSP1	Suspenders, Vinyl		PAPRSUSP1		
EVALKIT	Lever Lock Kit for EVA Back Plate				
PAPRSC2	Decon Shower Cap for EVA HE				
PAPRSC3	Decon Shower Cap for EVA OV/AG/HE				
PAPRPF2	Pre-Filter (120 pk) for EVA OV/AG/HE				
PAPRPFCOVER2	Pre-Filter Cover for EVA OV/AG/HE				
EVABP1	Back Plate for EVABELT1				
EVABP2	Back plate for EVABELT2		EVABUCKLE		
EVABUCKLE	Buckle for EVA				
EVACAPBLK	Vinyl Storage Cap Black (3 pk)				EVALLKIT
EVACAPRED	Vinyl Storage Cap Red (3 pk)				



PAPRSC2



PAPRSC3



PAPRPFCOVER2

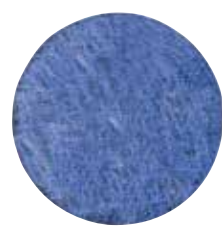

PAPRPF2



EVABP1



EVABP2



EVACAPBLK

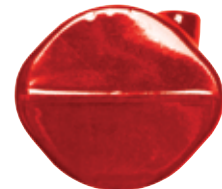

EVACAPRED

EVA Dust Covers

EVADCQC1	Dust cover, Tychem® QC for PAPRFC3
EVADCQC2	Dust cover, Tychem® QC for PAPRFC4
EVADCFK1	Dust cover, FR for PAPRFC3
EVADCFK2	Dust cover, FR for PAPRFC4

PAPR Replacement Head Pieces

Loose-Fitting Facepieces 20LF Series

NIOSH Approved with: PA20, PA30, PA30IS, EVA, EVAHL

PETG Lens

- 20LFL** Loose-Fitting Facepiece, Large
20LFM Loose-Fitting Facepiece, Medium
- Sewn in suspension
 - Latex-free
 - Quick-attach twist lock connection
 - 10 per package
- 20LF2L** Loose-Fitting Facepiece with Narrow Profile, Large - 7 1/2" - 8 1/2"
- Sewn in suspension
 - Latex-free
 - Quick-attach twist lock connection (Black)
 - 10 per package
- 20LF2M** Same as 20LF2L, Medium - 7" - 7 1/2"
20LF2S Same as 20LF2L, Small - 6 3/8" - 6 7/8"



20LFL

Single Bib Tychem® QC Hoods-CC20 Series

NIOSH Approved with: PA20, PA30, PA30IS, EVA, EVAHL

Acetate Lens

- 20TJ** Tychem® QC Single Bib Hood, Flex-Gear® Ratchet Suspension
20TJN Tychem® QC Single Bib Hood, No Suspension
- 10 per package
 - 9" long bib
- 20TJT** Tychem® QC Single Bib Quick-Attach T-Series Hood, Flex-Gear® Ratchet Suspension
20TJNT Tychem® QC Single Bib Quick-Attach T-Series Hood, No Suspension
- 10 per package
 - 9" long bib

PETG Lens

- 20TP** Tychem® QC Single Bib Hood for Painting, Solvent Resistant Lens, Flex-Gear® Ratchet Suspension
20TPN Tychem® QC Single Bib Hood for Painting, Solvent Resistant Lens, No Suspension
- 10 per package
 - 9" long bib
- 20TPT** Tychem® QC Single Bib Quick Attach T-Series Hood for Painting, Solvent Resistant Lens, Flex-Gear® Ratchet Suspension
20TPNT Tychem® QC Single Bib Quick-Attach T-Series Hood for Painting, Solvent Resistant Lens, No Suspension
- 10 per package
 - 9" long bib



20TJ

Double Bib Tychem® QC Hoods-CC20 Series

NIOSH Approved with: PA20, PA30, PA30IS, EVA, EVAHL

Acetate Lens

- 20TIC** Tychem® QC Double Bib Hood With Inner Bib, Flex-Gear® Ratchet Suspension, No Lens Tissue
- For use with Bullard hard hat
 - 9" long outer bib
 - 10 per package
- 20TICN** Tychem® QC Double Bib Hood with Inner Bib, No Suspension
20TICNX Tychem® QC Double Bib Hood With Inner Bib, No Suspension, No Lens Tissue
- 20TICT** Tychem® QC Double Bib Quick-Attach T-Series Hood With Inner Bib, Flex-Gear® Ratchet Suspension, No Lens Tissue
- For use with Bullard hard hat
 - 9" long outer bib
 - 10 per package
- 20TICNT** Tychem® QC Double Bib Quick-Attach T-Series Hood with Inner Bib, No Suspension
20TICNXT Tychem® QC Double Bib Quick-Attach T-Series Hood With Inner Bib, No Suspension, No Lens Tissue



20TIC

PAPR Replacement Head Pieces

Double Bib Tychem® QC Hoods-CC20 Series

NIOSH Approved with: PA20, PA30, PA30IS, EVA, EVAHL

- RT1** Tychem® QC Double Bib Hoods
RT3 Tychem® QC Double Bib Hoods
- Inner Bib
 - 20" long outer bib
 - Extra-large lens
 - No suspension required
 - 10 per package
 - Sport Neck Cuff

- RT1T** Tychem® QC Double Bib Quick-Attach T-Series Hoods
RT3T Tychem® QC Double Bib Quick-Attach T-Series Hoods
- Inner Bib
 - 20" long outer bib
 - Extra-large lens
 - No suspension required
 - 10 per package
 - Sport Neck Cuff



RT3

Double Bib Tychem® QC Hoods NIOSH Approved with: PA20, PA30, PA30IS, EVA, EVAHL

PETG Lens

- 20TPC** Tychem® QC Double Bib Hood for Painting, Solvent Resistant Lens, Ratchet Suspension
20TPCN Tychem® QC Double Bib Hood for Painting, Solvent Resistant Lens, No Suspension
- 9" long outer bib
 - 10 per package
- 20TPCT** Tychem® QC Double Bib Quick-Attach T-Series Hood for Painting, Solvent Resistant Lens, Flex-Gear® Ratchet Suspension
20TPCNT Tychem® QC Double Bib Quick-Attach T-Series Hood for Painting, Solvent Resistant Lens, No Suspension
- 9" long outer bib
 - 10 per package



20TPC

Taped and Sealed Seams

- 20TICS** Tychem® QC Double Bib Hood with Taped Seams, Flex-Gear® Ratchet Suspension
20TICSN Tychem® QC Single Bib Hood, No Suspension
- 19" long outer bib with taped seams
 - 10 per package
- 20TICST** Tychem® QC Double Bib Quick-Attach T-Series Hood with Taped Seams, Flex-Gear® Ratchet Suspension
20TICSNT Tychem® QC Single Bib Quick-Attach T-Series Hood, No Suspension
- 19" long outer bib with taped seams
 - 10 per package



20TICS

For use with Hard Hats

- 20TICH** Tychem® QC Double Bib Hood, for use with Bullard Hard Hat (Not Included)
20TICH30R Tychem® QC Double Bib Hood, with C30R Hard Hat
20TICH51R Tychem® QC Double Bib Hood, with S51R Hard Hat
- 9" long outer bib
 - 10 per package
- 20TICHT** Tychem® QC Double Bib Quick-Attach T-Series Hood, for use with Bullard Hard Hat (Not Included)
20TICHTC30R Tychem® QC Double Bib Quick-Attach T-Series Hood, with C30R Hard Hat
20TICHTS51R Tychem® QC Double Bib Quick-Attach T-Series Hood, with S51R Hard Hat
- 9" long outer bib
 - 10 per package



20TICH

PAPR Replacement Head Pieces

Double Bib Tychem® SL Hoods CC20 Series

NIOSH Approved with: PA20, PA30, PA30IS, EVA, EVAHL

Acetate Lens

- 20SIC** Tychem® SL Double Bib Hood with Taped Seams, Flex-Gear® Ratchet Suspension
- 20SICN** Tychem® SL Double Bib Hood with Taped Seams, No Suspension
- 20SICNX** Tychem® SL Double Bib Hood with Taped Seams, No Suspension, No Lens Tissue
- 19" long outer bib
 - Five per package
- 20SICT** Tychem® SL Double Bib Quick-Attach T-Series Hood with Taped Seams, Flex-Gear® Ratchet Suspension
- 20SICNT** Tychem® SL Double Bib Quick-Attach T-Series Hood with Taped Seams, No Suspension
- 20SICNXT** Tychem® SL Double Bib Quick-Attach T-Series Hood with Taped Seams, No Suspension, No Lens Tissue
- 19" long outer bib
 - Five per package



20SIC

Vinyl Lens

- 20SICV** Tychem® SL Double Bib Hood with Taped Seams, Flex-Gear® Ratchet Suspension
- 20SICVN** Tychem® SL Double Bib Hood with Taped Seams, No Suspension
- 19" long outer bib
 - Five per package
- 20SICVT** Tychem® SL Double Bib Quick-Attach T-Series Hood with Taped Seams, Flex-Gear® Ratchet Suspension
- 20SICVNT** Tychem® SL Double Bib Quick-Attach T-Series Hood with Taped Seams, No Suspension
- 19" long outer bib
 - Five per package



20SICV

For use with Hard Hats - Vinyl Lens

- 20SICVH** Tychem® SL Double Bib Hood with Taped Seams, for use with Bullard Hard Hats
- 20SICVHC30R** Tychem® SL Double Bib Hood with Taped Seams, includes C30R Hard Hat
- 20SICVHS51R** Tychem® SL Double Bib Hood with Taped Seams, includes S51R Hard Hat
- 19" long outer bib
 - Five per package
- 20SICVHT** Tychem® SL Double Bib Quick-Attach T-Series Hood with Taped Seams, for use with Bullard Hard Hats
- 20SICVHTC30R** Tychem® SL Double Bib Quick-Attach T-Series Hood with Taped Seams, includes C30R Hard Hat
- 20SICVHTS51R** Tychem® SL Double Bib Quick-Attach T-Series Hood with Taped Seams, includes S51R Hard Hat
- 19" long outer bib
 - Five per package



20SICVH

For use with Hard Hats - Acetate Lens

- 20SICH** Tychem® SL Double Bib Hood with Taped Seams, for use with Bullard Hard Hats
- 20SICHC30R** Tychem® SL Double Bib Hood with Taped Seams, includes C30R Hard Hat
- 20SICHS51R** Tychem® SL Double Bib Hood with Taped Seams, includes S51R Hard Hat
- 9" long outer bib
 - Five per package
- 20SICHT** Tychem® SL Double Bib Quick-Attach T-Series Hood with Taped Seams, for use with Bullard Hard Hats
- 20SICHTC30R** Tychem® SL Double Bib Quick-Attach T-Series Hood with Taped Seams, includes C30R Hard Hat
- 20SICHTS51R** Tychem® SL Double Bib Quick-Attach T-Series Hood with Taped Seams, includes S51R Hard Hat
- 9" long outer bib
 - Five per package



20SICH



PAPR Replacement Head Pieces

Double Bib Nomex Grinding Hood - GR50 Series

NIOSH Approved with: EVA

Acetate Lens

GRH	Nomex Grinding Hood with Flex-Gear® Ratchet Suspension
GRH30R	Nomex Grinding Hood with C30R Hard Hat
GRHS51R	Nomex Grinding Hood with S51R Hard Hat
GRHT	Nomex Grinding Quick-Attach T-Series Hood
GRHT30R	Nomex Grinding Quick-Attach T-Series Hood with C30R Hard Hat
GRHTS51R	Nomex Grinding Quick-Attach T-Series Hood with S51R Hard Hat



Full-Face Masks

NIOSH Approved with: PA40, EVA

PASPECML	Spectrum® Full Facepiece - Medium/Large
PASPECS	Spectrum® Full Facepiece - Small



Half-Face Masks

NIOSH Approved with: EVA

FAM2L	Large Half-Mask
FAM2M	Medium Half-Mask
FAM2S	Small Half-Mask
	• Silicone
	• Includes head straps



PAPR Replacement Parts and Accessories

PAPR Headpiece Replacement Parts

- 20RT** Adjustable Flex-Gear® Ratchet Headband Suspension
- Poly brow pad
 - Fits sizes 6½ to 8 (52-64 mm)



- RBPCOTTON** Brow Pad
- Large, absorbent cotton replacement brow pad
 - Fits all Bullard suspensions
 - Easy, Velcro® design



- RBPVINYL** Brow Pad
- Vinyl replacement brow pad
 - Fits all Bullard suspensions
 - Easy, Velcro® design



- RBPCOOL** Brow Pad
- Polartec replacement brow pad
 - Wicking material moves sweat away from the worker's brow
 - Fits all Bullard suspensions
 - Easy, Velcro® design



- 20NC** Elastic Chinstrap
- For 20TG and 20RT suspensions
 - 10 per package



- 20LCL** Adhesive-Edged Mylar® Lens Covers for use with CC20 Series Hoods
- 25 per package

- 20LCLBP** Same as 20LCL
- Eight packs of 25



- RTLCL** Adhesive-Edged Mylar® Lens Covers for use with RT Series Hoods
- 25 per package



PAPR Replacement Parts and Accessories

PAPR Head Protection Replacement Parts

C30R

Hard Hat for use with 20TICH, 20SICH, GRH

- High-density polyethylene shell
- Full profile, wide brim
- Accessory slots for attachments
- 6-point Flex-Gear® ratchet suspension with large, absorbent cotton (RS6RC) brow pad
- Replacement brow pads available (RBPCOTTON, RBPVINYL, RBPCOOL)
- Meets or exceeds ANSI/ISEA Z89.1-2009, Type I, Class E & G requirements and CSA Z94.1-2005, Type 1, Class E & G requirements



S51R

Hard Hat for use with 20TICH, 20SICH, GRH

- High-density, polyethylene shell with flat front, low-profile design
- Accessory slots for cap attachments
- Rain trough brim
- 4-point Flex-Gear® ratchet suspension with poly (RS4RP) brow pad
- Replacement brow pads available (RBPCOTTON, RBPVINYL, RBPCOOL)
- Meets or exceeds ANSI/ISEA Z89.1-2009, Type I, Class E & G requirements and CSA Z94.1-2005, Type 1, Class E & G requirements, and EN 397:2012 requirements





PAPR Replacement Parts and Accessories

PAPR Head Protection Replacement Parts

- RS6RC** 6-pt. Suspension
- 6-point Flex-Gear® ratchet suspension
 - Large, absorbent cotton brow pad
 - Replacement brow pads available (RBPCOTTON, RBPVINYL, RBPCOOL)
 - Flex-points and nape cushion
 - Large, easy-to-turn ratchet knob
 - Vertical height adjustments (two front, three rear)
 - For Models C30, C33, and C34

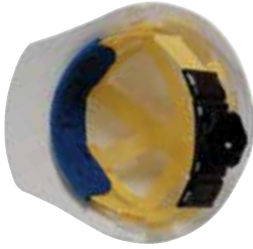

- RS4RC** 4-pt. Suspension
- 4-point Flex-Gear® ratchet suspension
 - Large absorbent cotton brow pad
 - Replacement brow pads available (RBPCOTTON, RBPVINYL, RBPCOOL)
 - Flex-points and nape cushion
 - Large, easy-to-turn ratchet knob
 - For Models S51, S61, S62, and S71



- ES42** 2-Point Elastic Chinstrap, Natural
- Latex-free, natural elastic
 - For Models S51, S61, S62, S71, C30, C33, C34, 911C, 911H, and Bump Cap



PAPR Replacement Parts and Accessories

Breathing Tubes for CC20 Loose-Fitting Facepieces

PA20, PA30, PA30IS, EVA, EVAHL

- PA20LFBTXL Extra Large Length - 38" Long
- PA20LFBT Regular Length - 32" Long
- PA20LFBTXS Extra Small Length - 26" Long



Breathing Tubes for CC20 and RT Hoods

PA20, PA30, PA30IS, EVA, EVAHL

- PA1BTXL Clamp Style Connection, Extra Large Length - 32" Long
- PA1BT Clamp Style Connection, Regular Length - 26" Long
- PA1BTXS Clamp Style Connection, Extra Small Length - 22" Long

- PAHBTXL Threaded Connection, Extra Large Length - 32" Long
- PAHBT Threaded Connection Regular Length - 26" Long
- PAHBTXS Threaded Connection Extra Small Length - 22" Long



Breathing Tubes for Spectrum® Full Face Masks

PA40, EVA

- PA4BT Regular Length - 33" Long



Breathing Tubes for FAMB Half-Face Masks

EVA

- PAFAMBT Regular Length - 33" Long



PAPR Replacement Parts and Accessories

Breathing Tube Seals

PA20, PA30, PA30IS, EVA

PA1BTS4 Breathing Tube Seal, package of 4



PA1BTS4

Breathing Tube Covers

PA20, PA30, PA30IS, PA40, EVA, EVAHL

20QCBTC Tychem® QC Breathing Tube Cover

20SLBTC Tychem® SL Breathing Tube Cover
• Length 24.5"

POLYBTC Clear Poly Breathing Tube Cover Sleeve
• 100 per package
• Length 38"



20QCBTC



POLYBTC

NMXBTC Nomex Breathing Tube Cover



NMXBTC

PAPR Storage Bags

PA20, PA30, PA30IS, PA40, EVA, EVAHL

PAPRBAG PAPR Storage Bag
• Green vinyl construction
• 22" long
• Includes shoulder strap
• PAPR not included

PPEBAG Storage Bag
• Large black rolling duffel
• 11" wide x 13" tall x 25" long
• Includes shoulder strap



PAPR Air Flow Indications

PA20, PA30, PA30IS, PA40, EVA, EVAHL

PA1AFI For Hoods

PA4AFI For Masks



Supplied Air Fitting Guide

The couplings pictured below are the most popular styles used on airline respirators. A coupling, which is made up of a socket and a plug, is also called a "QD" or "fitting" and comes in various socket (female) and plug (male) sizes. Couplings can have male, female, or hose barb ends for different types of connections.

Industrial Interchange/Hansen-Compatible

Snap-Tite - Also known as Foster; "short and stubby"

Schrader - Looks like a bullet; turn the sleeve to release

CEJN - Similar to Hansen; two hands must be used to disconnect

Bayonet - Long and skinny with pins on the side; no ball bearings to trap grit. Favorite of abrasive blasters

Dynaswivel® - Swivels in two axes to keep from kinking

Quick-Disconnect Nipples

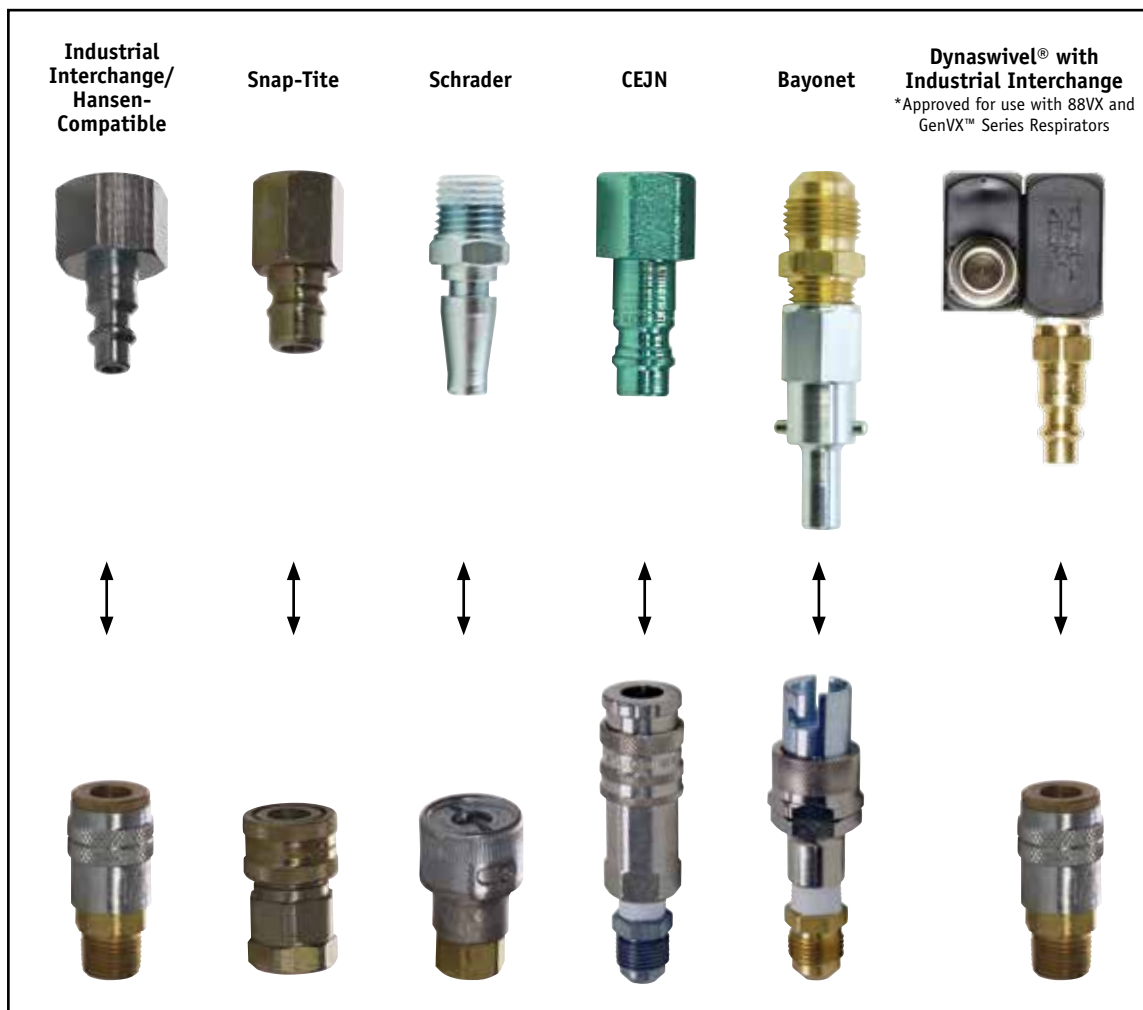

Quick-Disconnect Couplers

Supplied Air Respirators (SARs)

What is a Supplied Air Respirator?

Supplied Air Respirators deliver breathable air to the worker from a clean air source. The air can come from a variety of sources including high-pressure compressors, low-pressure pumps, or bottled air cylinders. In addition, Supplied Air Respirators can be configured with a variety of head tops including loose-fitting hoods, helmets, tight-fitting masks (full- and half-), or loose-fitting facepieces.

Supplied Air Respirator Advantages

There are many advantages to utilizing a Bullard Supplied Air Respirator System, including the ability to protect against a wide array of contaminants without any filter cartridges to purchase or replace. In addition, Bullard Supplied Air Respirators can be configured with heating/cooling tubes to increase worker comfort by as much as 40 degrees Fahrenheit. Finally, Bullard offers the largest selection of available head tops, including loose-fitting hoods that do not require fit testing.

Configuring a Supplied Air Respirator System

There are many choices to make when piecing together various components of a Supplied Air Respirator System.

The following steps may help simplify this intimidating task:

- Choose Air Source (Free-Air® Pump or Compressor)
- Choose Head Top
- Choose Suspension and/or Hard Hat
- Choose Breathing Tube
- Choose Flow Control
- Choose Cooling Vest (optional)



CC20 Series Airline Respirator

Simple, Effective, Ultra-Light

The CC20 Series Tychem® hoods provide a wide variety of simple, effective, and economical options for on-the-job respiratory protection. The result is better protection, improved productivity, and greater comfort that combines to produce the best value on the market. These hoods are available for use in a CC20 Series Airline Respirator configuration or Powered Air-Purifying Respirator configuration. These hoods are approved by NIOSH for use in Type C applications.

Proven Performance

In a series of 3rd party, independent tests by the Organizational Resources Counselors (ORG), the 20TIC hood was found to have the highest protection factors of the hoods tested from the pharmaceutical industry with all measurements above 150,000. This series of tests was cited in OSHA's final rule on Assigned Protection Factors (APFs) as the type of Simulated Workplace Protection Factor (SWPF) study that would provide the evidence acceptable for an APF of 1,000.

For a summary of this research, call Bullard Customer Service at 1-877-BULLARD (285-5273)

Unique Air Delivery System

A patented neck cuff design helps maintain positive pressure inside the hood to aid in keeping contaminants out. As air enters the hood, the inner collar inflates, providing a snug, comfortable fit around the neck and continuous flow of air to the worker's breathing zone.

Lightweight, Comfortable, and Economical

CC20 Series hoods are lighter and more comfortable than tight-fitting full-facepiece respirators. Covering the entire head, face, and neck, the hood provides splash and overspray protection and makes clean-up quick and easy.

A wide angle lens offers the largest field of vision among Tychem® hood-style respirators on the market, optimizing worker productivity and safety.

Available in a variety of styles, the hood is constructed of either DuPont™ Tychem® QC or Tychem® SL, depending on the job application. Taped and sealed seams are also available to provide additional protection for liquid penetration encountered on the job or during decontamination.

No Fit Testing

The hood requires neither fit testing nor extensive recordkeeping. It easily accommodates beards, prescription eyewear, or safety glasses.

Powered Air or Supplied Air

This hood series is available for use as a supplied air respirator (CC20 Series) or powered air respirator (EVA and EVAHL Series). The CC20 is a versatile hood suitable for almost any application.



CC20 Series Airline Respirator

CC20 Series Airline Respirator Selection Chart

1. Choose Head Top



- **20TJN** - Tychem® QC Single Bib Hood
- **20TPN** - With Solvent-Resistant Lens



- **20TICN** - Tychem® QC Double Bib Hood
- **20TPCN** - With Solvent-Resistant Lens



- **20SICN** - Tychem® SL Double Bib Hood w/Taped Seams
- **20TICSN** - Tychem® QC Double Bib Hood w/Taped Seams



- **20SICH** - Tychem® SL Double Bib Hood w/Taped Seams, for Hard Hats
- **20TICH** - Tychem® QC Double Bib, Hood for Hard Hats

2. Choose Head Top



- **20RT** - Adjustable Ratchet Headband Suspension



- **C30R** - With 6-point Flex-Gear® Ratchet Suspension For 20SICH, 20TICH, GRH



- **S51R** - With 4-point Flex-Gear® Ratchet Suspension For 20SICH, 20TICH, GRH

3. Choose Breathing Tube



- **20BT** - Breathing Tube for Hoods

4. Choose Flow Control Device



- 1/4" Continuous Flow
- **F30, F30B, F30S** Industrial Interchange
 - **F31** - Schrader
 - **F32** - Snap-Tite Steel
 - **F33** - Snap-Tite Brass
 - **F34** - Snap-Tite Stainless
 - **F37** - CEJN



- 1/4" Adjustable Flow
- **F40, F40B, F40S** Industrial Interchange
 - **F41** - Schrader
 - **F42** - Snap-Tite Steel
 - **F43** - Snap-Tite Brass
 - **F44** - Snap-Tite Stainless
 - **F47** - CEJN



- 1/2" Continuous Flow for Free-Air® Pumps
- **F35, F35B**, Industrial Interchange



- Cool Tubes for Compressed Air
- **AC100030, AC100030B, AC100030S** - 1/4" Industrial Interchange
 - **AC100031** - Schrader
 - **AC100032** - Snap-Tite Steel
 - **AC100033** - Snap-Tite Brass
 - **AC100034** - Snap-Tite Stainless
 - **AC100037** - CEJN



- Cool Tubes for Free-Air® Pumps
- **FRIGITRON2000** 1/2" Industrial Interchange
 - **FRIGITRON2000B** - Brass



- Hot/Cold Tubes
- **HC240030, HC240030B, HC240030S** 1/4" Industrial Interchange
 - **HC240031** - Schrader
 - **HC240032** - Snap-Tite Steel
 - **HC240033** - Snap-Tite Brass
 - **HC240034** - Snap-Tite Stainless
 - **HC240037** - CEJN

5. Choose Cooling Vest System



- **DC70ML** - Med/Lg Cool Vest
- **DC70XLXXL** - XL/XXL Cool Vest
- **DC705XL** - 5XL Cool Vest



- **DC5040, DC5040B, DC5040S** Dual-Cool Industrial Interchange
- **DC5041** - Dual-Cool Schrader
- **DC5042** - Dual-Cool Snap-Tite Steel
- **DC5043** - Dual-Cool Snap-Tite Brass
- **DC5044** - Dual-Cool Snap-Tite Stainless Steel
- **DC5047** - Dual-Cool CEJN

6. Choose Belt and/or Accessories



- **4612** - Nylon Belt



- **36501** - Decon Belt



- **20NC** - Chinstrap for Hoods

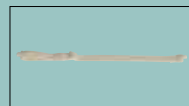

- **ES42** - Chinstrap for Hard Hats

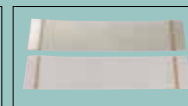

- **20LCL** - Lens Covers

CC20 Series Airline Respirator

CC20 Systems

A complete CC20 Series Airline Respirator consists of the following three components:

1. Respirator Hood with suspension
2. Breathing Tube with Flow Control Device
3. Breathing Air Supply Hose

All three Bullard components must be present and properly assembled to constitute a NIOSH approved respirator.

Approval No. TC-19C-154

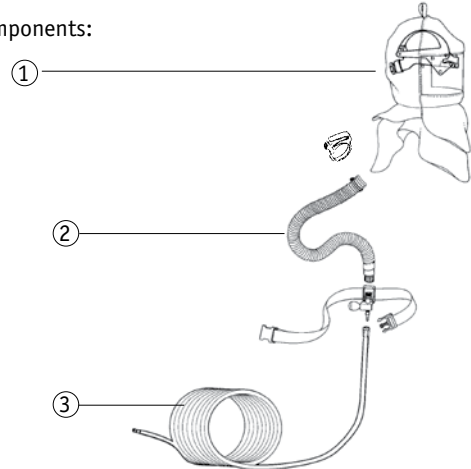

CC20 Series Constant Flow Respirator Systems for Use with Compressed Air

- CC20TJ30** Tychem® QC Single Bib Hood System
- 20TJN hood
 - 20RT Flex-Gear® Ratchet Suspension
 - V30 breathing tube assembly with F30 1/4" Industrial Interchange (Hansen compatible) nipple
 - 4612 nylon belt

- CC20TP30** Tychem® QC Single Bib Hood System
- 20TPN hood
 - 20RT Flex-Gear® Ratchet Suspension
 - V30 breathing tube assembly with F30 1/4" Industrial Interchange (Hansen compatible) nipple
 - 4612 Nylon Belt



-
-  **CC20TIC30** Tychem® QC Double Bib Hood System
- 20TICN hood
 - 20RT Flex-Gear® Ratchet Suspension
 - V30 breathing tube assembly with F30 1/4" Industrial Interchange (Hansen compatible) nipple
 - 4612 nylon belt

- CC20TPC30** Tychem® QC Double Bib Hood System
- 20TPCN hood
 - 20RT Flex-Gear® Ratchet Suspension
 - V30 breathing tube assembly with F30 1/4" Industrial Interchange (Hansen compatible) nipple
 - 4612 nylon belt
 - Solvent-resistant lens



 Best Seller

CC20 Series Airline Respirator

CC20 Series Constant Flow Respirator Systems for use with Compressed Air

- CC20TICH30** Tychem® QC Double Bib Hood System with Bullard Hard Hat
- 20TICH hood
 - Model C30R hard hat with Flex-Gear® Ratchet Suspension
 - V30 breathing tube assembly with F30 1/4" Industrial Interchange (Hansen compatible) nipple
 - 4612 nylon belt

- CC20TICH30S51** Tychem® QC Double Bib Hood System - For Use with Bullard Hard Hat
- Same as above with S51R hard hat with ratchet suspension



- CC20SIC30** Tychem® SL Double Bib Hood System with Taped Seams
- 20SICN hood
 - 20RT Flex-Gear® Ratchet Suspension
 - V30 breathing tube assembly with F30 1/4" Industrial Interchange (Hansen compatible) nipple
 - 4612 nylon belt



CC20 Series Airline Respirator

CC20 Series Constant Flow Respirator Systems for use with Clean-Air Box

- CC20CABSYS** One-Worker Respirator System
- CC20TIC30 respirator assembly
 - CAB15HA
 - 4696100 air supply hose
 - 20LCL lens covers (One pack of 25)
 - AC1000

- CC20CABSYS2M** Two-Worker Respirator System
- CC20TIC30 (2)
 - CAB30IRHA
 - 4691100 air supply hose (2)
 - 20LCL lens covers (One pack of 25)
 - AC1000 (2)



CC20 Series Constant Flow Respirator Systems for use with Free-Air® Pumps

- CC20SYS** One-Worker Respirator System
- CC20TIC35 respirator assembly
 - EDP10 Free-Air® pump
 - V20100ST 100' air supply hose
 - 20LCL lens covers (One pack of 25)

- CC20SYS50** Same as above with V2050ST 50' hose



- CC20TIC35** Tychem® QC Double Bib Hood System
- 20TICN hood
 - 20RT Flex-Gear® Ratchet Suspension
 - V35 breathing tube assembly with F35 1/2" Industrial Interchange (Hansen compatible) nipple
 - 4612 nylon belt

- CC20TICH35** Tychem® QC Double Bib Hood System with hard hat
- 20TICH hood
 - Bullard Model C30R Hard Hat with Flex-Gear® Ratchet Suspension
 - V35 breathing tube assembly with F35 1/2" Industrial Interchange (Hansen compatible) nipple
 - 4612 nylon belt

- CC20LF35** Tychem® QC Loose-Fitting Facepiece System
- 20LFL loose-fitting facepiece with sewn in suspension
 - X35 breathing tube assembly with 1/2" Industrial Interchange (Hansen compatible) nipple
 - 4612 nylon belt



CC20TIC35

CC20 Series Airline Respirator Replacement Hoods

Single Bib Tychem® QC Hoods

Also NIOSH Approved with: PA20, PA30, PA30IS, EVA, EVAHL

Acetate Lens

- 20TJ** Tychem® QC Single Bib Hood, Flex-Gear® Ratchet Suspension
- 20TJN** Tychem® QC Single Bib Hood, No Suspension
 - 10 per package
 - 9" long bib

PETG Lens

- 20TP** Tychem® QC Single Bib Hood, Flex-Gear® Ratchet Suspension
- 20TPN** Tychem® QC Single Bib Hood, No Suspension
 - 10 per package
 - 9" long bib



20TJ



Double Bib Tychem® QC Hoods

NIOSH Approved with: PA20, PA30, PA30IS, EVA, EVAHL

Acetate Lens

- 20TIC** Tychem® QC® Double Bib Hood with Inner Bib, Flex-Gear® Ratchet Suspension
-  **20TICN** Tychem® QC Double Bib Hood with Inner Bib, No Suspension
- 20TICNX** Tychem® QC Double Bib Hood With Inner Bib, No Suspension, No Lens Tissue
 - 9" long outer bib
 - 10 per package



20TIC

 Best Seller



Supplied Air Respirators

CC20 Series Airline Respirator Replacement Hoods

Double Bib Tychem® QC Hoods

NIOSH Approved with: PA20, PA30, PA30IS, EVA, EVAHL

PETG Lens

- 20TPC** Tychem® QC Double Bib Hood for Painting, Solvent Resistant Lens, Flex-Gear® Ratchet Suspension
- 20TPCN** Tychem® QC Double Bib Hood for Painting, Solvent Resistant Lens, No Suspension
- 20TPCNX** Tychem® QC Double Bib Hood for Painting, Solvent Resistant Lens, No Suspension, No Lens Tissue
- 9" long outer bib
 - 10 per package



20TP

Taped and Sealed Seams

- 20TICS** Tychem® QC Double Bib Hood with Taped Seams, Flex-Gear® Ratchet Suspension
- 20TICSN** Tychem® QC Double Bib Hood with Taped Seams, No Suspension
- 19" long outer bib
 - 10 per package



20TICS

For use with Hard Hats

- 20TICH** Tychem® QC Double Bib Hood for use with Bullard Hard Hat (Not Included)
- 9" long outer bib
 - 5 per package
- 20TICH30R** Tychem® QC Double Bib Hood, Includes C30R Hard Hat
- 20TICH51R** Tychem® QC Double Bib Hood, Includes S51R Hard Hat
- 9" long outer bib
 - 1 per package



20TICH

CC20 Series Airline Respirator

Double Bib Tychem® SL Hoods

NIOSH Approved with: PA20, PA30, PA30IS, EVA



Acetate Lens

- 20SIC** Tychem® SL Double Bib Hood with Taped Seams, Flex-Gear® Ratchet Suspension
- 20SICN** Tychem® SL Double Bib Hood with Taped Seams, No Suspension
- 20SICNX** 20SICN, No Lens Tissue
 - 19" long outer bib
 - 5 per package



20SIC

Vinyl Lens

- 20SICV** Tychem® SL Double Bib Hood with Taped Seams, Flex-Gear® Ratchet Suspension
- 20SICVN** Tychem® SL Double Bib Hood with Taped Seams, No Suspension
 - 19" long outer bib
 - 5 per package



20SICV

For use with Hard Hats - Vinyl Lens

- 20SICVH** Tychem® SL Double Bib Hood with Taped Seams, Hard Hat not included
- 20SICVH30R** Tychem® SL Double Bib Hood with Taped Seams, with C30R Hard Hat
- 20SICVHS51R** Tychem® SL Double Bib Hood with Taped Seams, with S51R Hard Hat
 - 9" long outer bib
 - 5 per package



20SICVH

For use with Hard Hats - Acetate Lens

- 20SICH** Tychem® SL Double Bib Hood with Taped Seams, Hard Hat not included
- 20SICH30R** Tychem® SL Double Bib Hood with Taped Seams, with C30R Hard Hat
- 20SICH51R** Tychem® SL Double Bib Hood with Taped Seams, with S51R Hard Hat
 - 9" long outer bib
 - 5 per package



20SICH

CC20 Series Airline Respirator

CC20 Series Headpiece Replacement Parts

- 20RT** Adjustable Flex-Gear® Ratchet Headband Suspension
- Poly brow pad
 - Fits sizes 6½ to 8 (52-64 mm)



-
- RBPCOTTON** Brow Pad
- Large, absorbent cotton replacement brow pad
 - Fits all Bullard suspensions
 - Easy, velcro design



-
- RBPVINYL** Brow Pad
- Vinyl replacement brow pad
 - Fits all Bullard suspensions
 - Easy, velcro design



-
- RBPCOOL** Brow Pad
- Polartec replacement brow pad
 - Wicking material moves sweat away from the worker's brow
 - Fits all Bullard suspensions
 - Easy, velcro design



-
- 20NC** Elastic Chinstrap
- For 20TG and 20RT suspensions
 - 10 per package



-
- 20LCL** Adhesive-Edged Mylar® Lens Covers
- 25 per package
- 20LCLBP** Same as 20LCL
- Eight packs of 25



CC20 Series Airline Respirator

CC20 Head Protection

C30R

Hard Hat for use with 20TICH, 20SICH, GRH

- High-density polyethylene shell
- Full profile, wide brim
- Accessory slots for attachments
- 6-point Flex-Gear® ratchet suspension with large, absorbent cotton (RS6RC) brow pad
- Replacement brow pads available (RBPCOTTON, RBPVINYL, RBPCOOL)
- Meets or exceeds ANSI/ISEA Z89.1-2009, Type I, Class E & G requirements and CSA Z94.1-2005, Type 1, Class E & G requirements



S51R

Hard Hat for use with 20TICH, 20SICH, GRH

- High-density, polyethylene shell with flat front, low-profile design
- Accessory slots for cap attachments
- Rain trough brim
- 4-point Flex-Gear® ratchet suspension with poly (RS4RP) brow pad
- Replacement brow pads available (RBPCOTTON, RBPVINYL, RBPCOOL)
- Meets or exceeds ANSI/ISEA Z89.1-2009, Type I, Class E & G requirements and CSA Z94.1-2005, Type 1, Class E & G requirements, and EN 397:2012 requirements



CC20 Series Airline Respirator

CC20 Head Protection Replacement Parts

RS6RC

6-pt. Suspension

- 6-point Flex-Gear® ratchet suspension
- Large, absorbent cotton brow pad
- Replacement brow pads available (RBPCOTTON, RBPVINYL, RBPCOOL)
- Flex-points and nape cushion
- Large, easy-to-turn ratchet knob
- Vertical height adjustments (two front, three rear)
- For Models C30, C33, and C34

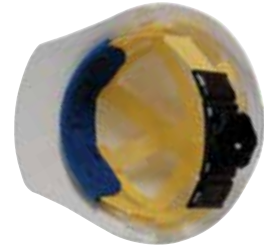

RS4RC

4-pt. Suspension

- 4-point Flex-Gear® ratchet suspension
- Large absorbent cotton brow pad
- Replacement brow pads available (RBPCOTTON, RBPVINYL, RBPCOOL)
- Flex-points and nape cushion
- Large, easy-to-turn ratchet knob
- For Models S51, S61, S62, and S71



ES42

2-Point Elastic Chinstrap, Natural

- Latex-free, natural elastic
- For Models S51, S61, S62, S71, C30, C33, C34, 911C, 911H, and Bump Cap

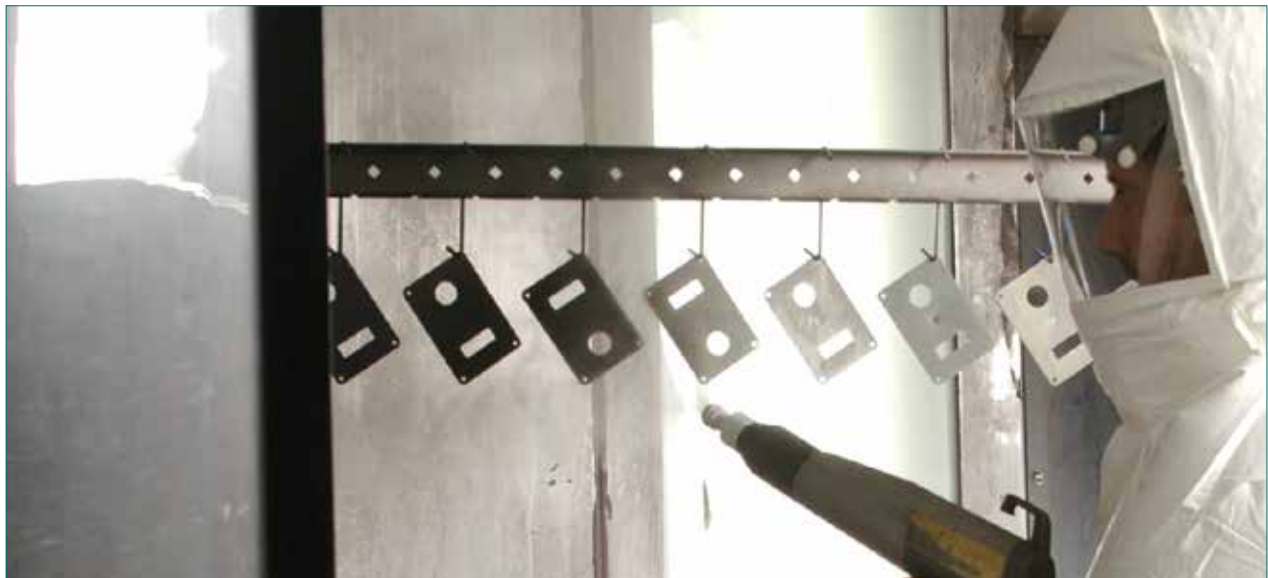

CC20 Series Airline Respirator

CC20 Series Breathing Tube Assemblies for Hoods

- Assemblies include 20BT breathing tube, 4612 nylon belt and S18051 clamp

Constant Flow Assemblies

- V30**
- With F30 1/4" Industrial Interchange (Hansen compatible) quick-disconnect nipple
 - For use with compressed air



Adjustable Flow Assemblies

- V40**
- With F40 1/4" Industrial Interchange (Hansen compatible) quick-disconnect nipple
 - For use with compressed air



- V31**
- With F31 1/4" Schrader quick-disconnect nipple
 - For use with compressed air



- V41**
- With F41 1/4" Schrader quick-disconnect nipple
 - For use with compressed air



- V32**
- With F32 1/4" Snap-Tite steel quick-disconnect nipple
 - For use with compressed air



- V42**
- With F42 1/4" Snap-Tite steel quick-disconnect nipple
 - For use with compressed air



- V33**
- With F33 1/4" Snap-Tite brass quick-disconnect nipple
 - For use with compressed air



- V43**
- With F43 1/4" Snap-Tite brass quick-disconnect nipple
 - For use with compressed air



- V35**
- With F35 1/2" industrial interchange (Hansen compatible) quick-disconnect nipple
 - For use with Bullard Free-Air® pumps



CC20 Series Airline Respirator

CC20 Series Breathing Tube Replacement Parts

- F30** Constant Flow Control Valve
F30B Constant Flow Control Valve, Brass with Nylon Belt
F30S Constant Flow Control Valve, Stainless Steel with Nylon Belt
F30SD Constant Flow Control Valve, Stainless Steel with Decon Belt
F30VDB Constant Flow Control Valve with Vinyl Belt
- 1/4" Industrial Interchange (Hansen compatible) quick-disconnect nipple
 - Threaded hose connector
 - Connects to 88VXBT, GVXBT, L99BT, 20BT, or 20LFBT
 - For use with compressed air



-
- F31** Constant Flow Control Valve
- Same as above with 1/4" Schrader quick-disconnect nipple



-
- F32** Constant Flow Control Valve
- Same as F30 above with 1/4" Snap-Tite steel quick-disconnect nipple



-
- F33** Constant Flow Control Valve
- Same as F30 above with 1/4" Snap-Tite brass quick-disconnect nipple



-
- F34** Constant Flow Control Valve
- Same as F30 above with 1/4" Snap-Tite stainless steel quick-disconnect nipple



CC20 Series Airline Respirator

CC20 Series Breathing Tube Replacement Parts

- F35** Constant Flow Control Valve, Steel
F35B Constant Flow Control Valve, Brass
- 1/2" Industrial Interchange (Hansen compatible) quick-disconnect nipple
 - Threaded hose connector
 - Nylon belt
 - Connects to 88VXBT, L99BT, 20BT, or 20LFBT
 - For use with Bullard Free-Air® pumps



- F37** Constant Flow Control Valve
- Same as F35 above with 1/4" CEJN quick-disconnect nipple
 - For use with compressed air



- F40** Adjustable Flow Control Valve, Steel, Nylon Belt
F40B Adjustable Flow Control Valve, Brass, Nylon Belt
F40S Adjustable Flow Control Valve, Stainless Steel, Nylon Belt
F40VDB Adjustable Flow Control Valve, Vinyl Decon Belt
- 1/4" Industrial Interchange (Hansen compatible) quick-disconnect nipple
 - Threaded hose connector
 - Connects to 88VXBT, L99BT, 20BT or 20LFBT
 - For use with compressed air



- F41** Adjustable Flow Control Valve
- Same as F40 above with 1/4" Schrader quick-disconnect nipple
 - Nylon belt



CC20 Series Airline Respirator

CC20 Series Breathing Tube Replacement Parts

F42

Adjustable Flow Control Valve

- 1/4" Snap-Tite steel quick-disconnect nipple
- Threaded hose connector
- Nylon belt
- Connects to 88VXBT, GVXBT, L99BT, 20BT, or 20LFBT
- For use with compressed air



F43

Adjustable Flow Control Valve

- Same as F42 above with 1/4" Snap-Tite brass quick-disconnect nipple



F44

Adjustable Flow Control Valve

- Same as F42 above with 1/4" Snap-Tite stainless steel quick-disconnect nipple



F47

Flow Control Valve

- Same as F42 above with 1/4" CEJN quick-disconnect nipple



CC20 Series Airline Respirator

CC20 Series Breathing Tube Replacement Parts

20BT Breathing Tube for Hoods
• Nipple not included
• S18051 clamp



20LFBT Breathing Tube for Loose-Fitting Facepieces
• Nipple not included



S18051 Breathing Tube Clamp
• 10 per package



S18051BLACK Breathing Tube Clamp, Black
• 10 per package



4612 Nylon Belt



36501 Vinyl Decon Belt



20QCBTC Tychem® QC Breathing Tube Cover
20SLBTC Tychem® SL Breathing Tube Cover
• Length 24.5"



POLYBTC Clear Poly Breathing Tube Cover Sleeve
• 100 per package
• Length 38"



Supplied Air Respirators

20LF Series Loose-Fitting Facepiece

Leightweight, Comfortable Protection

The Bullard Loose-Fitting Facepiece provides comfortable, affordable, and effective protection from a wide range of respiratory hazards. Available for use as a CC20 Series supplied air or EVA Series Powered Air-Purifying Respirator, this loose-fitting facepiece constructed of DuPont™ Tychem® QC provides its users with versatility, advanced features, and ease of use. The Bullard Loose-Fitting Facepiece is approved by NIOSH. The Loose-Fitting Facepiece is used in a wide variety of applications including:

- Pharmaceutical Manufacturing
- General Industry
- General Maintenance
- Woodworking
- Spray Foam
- Painting/Powder Coating
- Healthcare Workers

Features and Benefits

Soft Plenum Delivery System

The Loose-Fitting Facepiece utilizes a unique Soft Plenum design to deliver air to the worker's breathing zone. As air enters the facepiece from the twist-lock breathing tube connection, the soft plenum inflates on the top of the head. The air is then directed down through an opening at the top of the facepiece directly into the worker's breathing zone. Unlike other loose-fitting facepieces, this design provides more airflow where it is most needed and helps to prevent fogging of the lens or drying of the eyes.

Latex-Free Construction

Bullard Loose-Fitting Facepieces are completely latex-free, eliminating any concern over latex sensitivities by the wearer. The facial seal material is a unique engineered material that is 100% latex-free.

Built-in Suspension

The sewn-in soft suspension provides a comfortable fit to the worker's head, while allowing for complete disposability of the facepiece. This feature also allows for the facepiece to be easily donned/removed with no assembly required.

Twist-Lock Breathing Tube Connection

The twist-lock breathing tube connection provides ease of use by allowing quick connection or disassembly of the breathing tube whether on or off the worker's head.

Wide Angle Lens

The Bullard Loose-Fitting Facepiece features the largest lens available. This gives the worker a wide panoramic field of vision, virtually eliminating the "closed-in" feeling of many respirators.

Climate Control Option

When used as a CC20 Series airline respirator, the Loose-Fitting Facepiece may be used with the optional climate control devices. This allows workers to heat or cool incoming air by as much as 35°F to improve comfort and enhance productivity.



20LF Loose-Fitting Facepiece

20LF Loose-Fitting Facepiece Chart

1. Choose Head Top



- 20LFM - Loose-Fitting Facepiece, Medium
- 20LFL - Loose-Fitting Facepiece, Large



- 20LF2S, 20LF2M, 20LF2L - Narrow Profile

2. Choose Breathing Tube



- 20LFBT - Breathing Tube for Hoods

3. Choose Flow Control Device



- 1/4" Continuous Flow
- F30, F30B, F30S Industrial Interchange
 - F31 - Schrader
 - F32 - Snap-Tite Steel
 - F33 - Snap-Tite Brass
 - F34 - Snap-Tite Stainless
 - F37 - CEJN

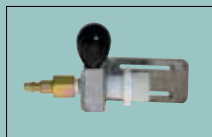

- 1/4" Adjustable Flow
- F40, F40B, F40S Industrial Interchange
 - F41 - Schrader
 - F42 - Snap-Tite Steel
 - F43 - Snap-Tite Brass
 - F44 - Snap-Tite Stainless
 - F47 - CEJN



- 1/2" Continuous Flow for Free-Air® Pumps
- F35, F35B, - Industrial Interchange

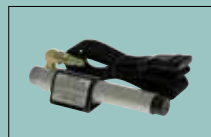

- Cool Tubes for Compressed Air
- AC100030, AC100030B, AC100030S 1/4" Industrial Interchange
 - AC100031 - Schrader
 - AC100032 - Snap-Tite Steel
 - AC100033 - Snap-Tite Brass
 - AC100034 - Snap-Tite Stainless
 - AC100037 - CEJN



- Cool Tubes for Free-Air® Pumps
- FRIGITRON2000 1/2" Industrial Interchange
 - FRIGITRON200B - Brass

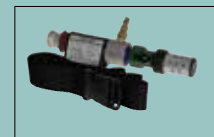

- Hot/Cold Tubes
- HC240030, HC240030B, HC240030S 1/4" Industrial Interchange
 - HC240031 - Schrader
 - HC240032 - Snap-Tite Steel
 - HC240033 - Snap-Tite Brass
 - HC240034 - Snap-Tite Stainless
 - HC240037 - CEJN

4. Choose Cooling Vest System



- DC70ML - Med/Lg Cool Vest
- DC70LXXL - XL/XXL Cool Vest
- DC705XL - 5XL Cool Vest



- DC5040, DC5040B, DC5040S Dual-Cool Industrial Interchange
- DC5041 - Dual-Cool Schrader
- DC5042 - Dual-Cool Snap-Tite Steel
- DC5043 - Dual-Cool Snap-Tite Brass
- DC5044 - Dual-Cool Snap-Tite Stainless Steel
- DC5047 - Dual-Cool CEJN

5. Choose Belt and/or Accessories



- 4612 - Nylon Belt



- 36501 - Decon Belt

20LF Series Airline Respirator

20LF Series Constant Flow Respirator Systems for Use with Compressed Air

Standard Face Pieces

- CC20LFL30** Tychem® QC Loose-Fitting Face Piece System
- 20LFL large loose-fitting face piece
 - X30 breathing tube assembly with F30 ¼" Industrial Interchange (Hansen compatible) nipple
 - 4612 nylon belt
 - Soft Plenum air delivery system
 - Latex-free construction with twist-lock breathing tube connection

- CC20LFM30** Tychem® QC Loose-Fitting Face Piece System
- 20LFM medium loose-fitting face piece
 - X30 breathing tube assembly with F30 ¼" Industrial Interchange (Hansen compatible) nipple
 - 4612 nylon belt
 - Soft Plenum air delivery system
 - Latex-free construction with twist-lock breathing tube connection



Narrow Face Pieces

- CC20LF2L30** Tychem® QC Loose-Fitting Face Piece System
- 20LFM medium loose-fitting face piece
 - X30 breathing tube assembly with F30 ¼" Industrial Interchange (Hansen compatible) nipple
 - 4612 nylon belt
 - Soft Plenum air delivery system
 - Latex-free construction with twist-lock breathing tube connection

- CC20LF2M30** Tychem® QC Loose-Fitting Face Piece System
- 20LFM medium loose-fitting face piece
 - X30 breathing tube assembly with F30 ¼" Industrial Interchange (Hansen compatible) nipple
 - 4612 nylon belt
 - Soft Plenum air delivery system
 - Latex-free construction with twist-lock breathing tube connection

- CC20LF2S30** Tychem® QC Loose-Fitting Face Piece System
- 20LFL small loose-fitting face piece
 - X30 breathing tube assembly with F30 ¼" Industrial Interchange (Hansen compatible) nipple
 - 4612 nylon belt
 - Soft Plenum air delivery system
 - Latex-free construction with twist-lock breathing tube connection



20LF Series Constant Flow Respirator Systems for use with Free-Air® Pumps

Standard Face Pieces

- C20LFL35** Tychem® QC Loose-Fitting Face Piece System
- 20LFL large loose-fitting face piece
 - X35 breathing tube assembly with F35 ½" Industrial Interchange (Hansen compatible) nipple
 - 4612 nylon belt
 - Soft Plenum air delivery system
 - Latex-free construction with twist-lock breathing tube connection

- CC20LFM35** Tychem® QC Loose-Fitting Face Piece System
- 20LFM medium loose-fitting face piece
 - X35 breathing tube assembly with F35 ½" Industrial Interchange (Hansen compatible) nipple
 - 4612 nylon belt
 - Soft Plenum air delivery system
 - Latex-free construction with twist-lock breathing tube connection



20LF Series Airline Respirator Replacement Hoods

Loose-Fitting Facepieces

Also NIOSH Approved with: PA20, PA30, PA30IS, EVA, EVAHL

- 20LFL** Loose-Fitting Facepiece, Large
20LFM Same as 20LFL, Medium
- Sewn in suspension
 - Latex-free
 - Quick-attach twist lock connection
 - Ten per package
- 20LFL50** Same as 20LFL, 50 per package



20LFL

- 20LF2L** Loose-Fitting Facepiece with Narrow Profile, Large
- 20LF2M** Same as 20LF2L, Medium
20LF2S Same as 20LF2L, Small
- Sewn in suspension
 - Latex-free
 - Quick-attach twist lock connection
 - Ten per package
- 20LF2L50** Same as 20LF2L, 50 per package
20LF2M50 Same as 20LF2M, 50 per package
20LF2S50 Same as 20LF2S, 50 per package



20LF2L



20LF Series Airline Respirator

20LF Series Breathing Tube Assemblies for Loose-Fitting Facepieces

- Assemblies include 20LFBT breathing tube and 4612 nylon belt

Constant Flow Assemblies

- X30**
- With F30 1/4" Industrial Interchange (Hansen compatible) quick-disconnect nipple
 - For use with compressed air



Adjustable Flow Assemblies

- X40**
- With F40 1/4" Industrial Interchange (Hansen compatible) quick-disconnect nipple
 - For use with compressed air



-
- X31**
- With F31 1/4" Schrader quick-disconnect nipple
 - For use with compressed air



-
- X32**
- With F32 1/4" Snap-Tite steel quick-disconnect nipple
 - For use with compressed air



-
- X33**
- With F33 1/4" Snap-Tite brass quick-disconnect nipple
 - For use with compressed air



-
- X35**
- With F35 1/2" Industrial Interchange (Hansen compatible) quick-disconnect nipple
 - For use with Bullard Free-Air® pumps



20LF Series Airline Respirator

20LF Series Breathing Tube Replacement Parts

- F30** Constant Flow Control Valve
F30B Constant Flow Control Valve, Brass with Nylon Belt
F30S Constant Flow Control Valve, Stainless Steel with Nylon Belt
F30SD Constant Flow Control Valve, Stainless Steel with Decon Belt
F30VDB Constant Flow Control Valve with Vinyl Belt
- $\frac{1}{4}$ " industrial interchange (Hansen compatible) quick-disconnect nipple
 - Threaded hose connector
 - Connects to 88VXBT, GVXBT, L99BT, 20BT, or 20LFBT
 - For use with compressed air
 - 4612 Nylon Belt



- F31** Constant Flow Control Valve
- Same as above with $\frac{1}{4}$ " Schrader quick-disconnect nipple



- F32** Constant Flow Control Valve
- Same as F30 above with $\frac{1}{4}$ " Snap-Tite steel quick-disconnect nipple



- F33** Constant Flow Control Valve
- Same as F30 above with $\frac{1}{4}$ " Snap-Tite brass quick-disconnect nipple



- F34** Constant Flow Control Valve
- Same as F30 above with $\frac{1}{4}$ " Snap-Tite stainless steel quick-disconnect nipple



20LF Series Airline Respirator

20LF Series Breathing Tube Replacement Parts

F35

Constant Flow Control Valve, Steel

F35B

Constant Flow Control Valve, Brass

- 1/2" industrial interchange (Hansen compatible) quick-disconnect nipple
- Threaded hose connector
- 4612 Nylon belt
- Connects to 88VXBT, GVXBT, L99BT, 20BT, or 20LFBT
- For use with Bullard Free-Air® pumps



F37

Constant Flow Control Valve

- Same as F35 above with 1/4" CEJN quick-disconnect nipple
- For use with compressed air



F40

Adjustable Flow Control Valve, Steel, Nylon Belt

F40B

Adjustable Flow Control Valve, Brass, Nylon Belt

F40S

Adjustable Flow Control Valve, Stainless Steel, Nylon Belt

F40VDB

Adjustable Flow Control Valve, Vinyl Decon Belt

- 1/4" industrial interchange (Hansen compatible) quick-disconnect nipple
- Threaded hose connector
- Connects to 88VXBT, GVXBT, L99BT, 20BT or 20LFBT
- For use with compressed air



F41

Adjustable Flow Control Valve

- Same as F40 above with 1/4" Schrader quick-disconnect nipple
- 4612 Nylon belt





20LF Series Airline Respirator

20LF Series Breathing Tube Replacement Parts

20LFBT Breathing Tube for Loose-Fitting Facepieces
• Nipple not included



4612 Nylon Belt



36501 Vinyl Decon Belt



20QCBTC Tychem® QC Breathing Tube Cover
20SLBTC Tychem® SL Breathing Tube Cover
• Length 24.5"



POLYBTC Clear Poly Breathing Tube Cover Sleeve
• 100 per package
• Length 38"



Supplied Air Respirators

RT Series Airline Respirator

Innovative and Proven

Similar to the proven design of the Bullard CC20, the top performing hood in the OSHA-acknowledged ORC Study, the RT Series hood family represents a significant improvement in the realm of Tychem® hood protection. In addition to the recognized benefits of hood-style respirators (no fit testing, no facial hair issues, and eyewear accommodation), the RT Series offers several unique, customer-driven features that make it stand out from other Tychem® hoods.

Patent-pending Air Delivery System

Air flows into the neck cuff and is then directed through a three-channel air delivery system that delivers the air over the user's head, down the front of the lens and into the breathing zone. This unique air delivery method provides for a positive seal, minimizes fogging of the lens, minimizes dry eyes and nasal passages, and provides a reservoir of breathing air to help maintain positive pressure.

Panoramic View

The domed feature of the RT Series hood lens, provides added visibility and allows more light in minimizing the "closed-in," claustrophobic feeling sometimes experienced in other respirator hoods. A latex-free elastic band located in the neck cuff promotes curvature of the lens while aiding in the neck cuff's inflation.

Long Inner and Outer Bibs

The 20" long outer bibs of the RT Series provide splash protection and feature Velcro® straps that connect the front and rear outer bibs providing a custom fit, eliminating the possibility of the bib's "flipping up" during bending or scooping operations and providing added stability to the hood. Inner bibs add an additional barrier between the worker and the contaminants. With the bibs tucked in, the excess air flowing out of the respirator will travel across the user's body, creating a cooling effect.

Tychem® SL (Saranex) Visual

The RT Series Hood, made from DuPont™ Tychem®, is available in either Tychem® QC (RT1 and RT3) or Tychem® SL (RT2 and RT4). The RT2 and RT4, constructed of Tychem® SL, features taped and sealed seams to minimize the potential for any inward leakage at the sewn seams. Tychem® SL is Saranex coated and provides excellent permeation characteristics against more caustic chemicals.

Ultimate Disposability

The RT Series Hood is available as a stand-alone replacement hood for those applications that allow for decontamination and reuse of the breathing tube. For those applications or processes that do not allow for decontamination, the RT Series is available fully assembled with a disposable lightweight breathing tube. After exiting from the area, the user may dispose of the complete assembly.

RT Series Hoods Perform in SWPF Study

At Bullard's request, the US Army's RDECOM (Research Development and Engineering Command) Center performed a simulated workplace protection factor (SWPF) study using the well-respected ORC Study protocol. Exercises were chosen to simulate activities that may be seen in a pharmaceutical manufacturing application. The RT Series Hood was shown to have 5th percentile SWPFs in excess of 100,000!



RT Series Airline Respirator

RT Series Airline Respirator Selection Chart

1. Choose Head Top



• **RT1** - Tychem® QC Double Bib Hood



• **RT2** - Tychem® SL (Saranex coated) Double Bib Hood with Taped Seams



• **RT3** - Tychem® QC Double Bib Hood



• **RT4** - Tychem® SL (Saranex coated) Double Bib Hood with Taped Seams

2. Choose Breathing Tube



• **20BT** - Breathing Tube for Hoods



• **RTBT** - Disposable Breathing Tube

3. Choose Flow Control Device



1/4" Continuous Flow
• **F30, F30B, F30S** Industrial Interchange
• **F31** - Schrader
• **F32** - Snap-Tite Steel
• **F33** - Snap-Tite Brass
• **F34** - Snap-Tite Stainless
• **F35** - Industrial Interchange

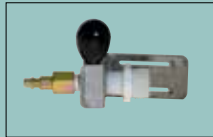

1/4" Adjustable Flow
• **F40, F40B, F40S** Industrial Interchange
• **F41** - Schrader
• **F42** - Snap-Tite Steel
• **F43** - Snap-Tite Brass
• **F44** - Snap-Tite Stainless



Cool Tubes for Compressed Air
• **AC100030, AC100030B, AC100030S** 1/4" Industrial Interchange
• **AC100031** - Schrader
• **AC100032** - Snap-Tite Steel
• **AC100033** - Snap-Tite Brass
• **AC100034** - Snap-Tite Stainless



Cool Tubes for Free-Air® Pumps
• **FRIGITRON2000** 1/2" Industrial Interchange
• **FRIGITRON2000B** - Brass



Hot/Cold Tubes
• **HC240030, HC240030B, HC240030S** Industrial Interchange
• **HC240031** - Schrader
• **HC240032** - Snap-Tite Steel
• **HC240033** - Snap-Tite Brass
• **HC240034** - Snap-Tite Stainless

4. Choose Belt and/or Accessories



• **4612** - Nylon Belt



• **36501** - Decon Belt



• **RTLCLens Covers**

5. Choose Cooling Vest System



• **DC70ML** - Med/Lg Cool Vest
• **DC70XL** - XL/XXL Cool Vest
• **DC705XL** - 5XL Cool Vest



• **DC5040, DC5040B, DC5040S** Dual-Cool Industrial Interchange
• **DC5041** - Dual-Cool Schrader
• **DC5042** - Dual-Cool Snap-Tite Steel
• **DC5043** - Dual-Cool Snap-Tite Brass
• **DC5044** - Dual-Cool Snap-Tite Stainless Steel

RT Series Airline Respirator

RT Systems

A complete RT Series Airline Respirator consists of the following three components:

1. Respirator Hood
2. Breathing Tube with Fitting or Optional Climate Control Assembly
3. Breathing Air Supply Hose

All three Bullard components must be present and properly assembled to constitute a
Approval No. TC-19C-412, Type C, Continuous Flow Class

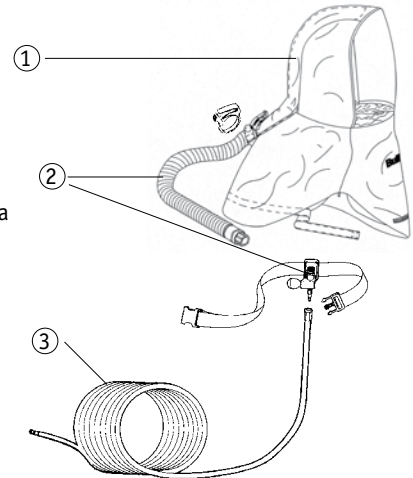

RT Series Constant Flow Respirator Systems for Compressed Air



RT330

Constant Flow Respirator Assembly

- RT3 Tychem® QC double bib hood system - extra-large lens
- No suspension required
- V30 breathing tube assembly with F30 1/4" Industrial Interchange (Hansen compatible) nipple and 4612 nylon belt
- For use with compressed air
- Sport neck cuff



Best Seller

RT430

Constant Flow Respirator Assembly

- RT4 Tychem® SL (Saranex coated) double bib hood system - extra-large lens
- Taped seams
- No suspension required
- V30 breathing tube assembly with F30 1/4" Industrial Interchange (Hansen compatible) nipple and 4612 nylon belt
- For use with compressed air
- Sport neck cuff



RT Series Airline Respirator

RT Series Disposable Respirator Systems

- RT3DA** Constant Flow Disposable Assembly with Sport Neck Cuff
- RT3 Tychem® QC double bib hood system - extra-large lens
 - No suspension required
 - RTBT lightweight disposable breathing tube assembly
 - Preamsembled and individually bagged
 - Flow control device sold separately
 - 10 per package



RT3DA



RT1DA

- RT1DA** Same assembly as above with Inflatable Neck Cuff

- RT4DA** Constant Flow Disposable Assembly with Sport Neck Cuff
- RT4 Tychem® SL (Saranex coated) double bib hood system - extra-large lens
 - No suspension required
 - RTBT lightweight disposable breathing tube assembly
 - Preamsembled and individually bagged
 - Flow control device sold separately
 - 10 per package



RT4DA



RT2DA

- RT2DA** Same assembly as above with Inflatable Neck Cuff

RT Series Replacement Hoods

-  **RT3** Tychem® QC Double Bib Hoods with Sport Neck Cuff
- Inner bib, 20" long outer bib
 - Bib retention straps
 - Extra-large lens
 - No suspension required
 - 10 per package



RT3



RT1

- RT1** Same assembly as above with Inflatable Neck Cuff

 **Best Seller**

- RT4** Tychem® SL (Saranex coated) Double Bib Hoods with Sport Neck Cuff
- Inner bib, 20" long outer bib, taped seams
 - Bib retention straps
 - Extra-large lens
 - No suspension required
 - 10 per package



RT4



RT2

- RT2** Same assembly as above with Inflatable Neck Cuff



Supplied Air Respirators

RT Series Airline Respirator

RT Series Breathing Tube Assemblies

- V30** Constant Flow Breathing Tube Assembly for Hoods
- 20BT breathing tube
 - F30 3/4" industrial interchange (Hansen compatible) quick-disconnect nipple
 - 4612 nylon belt
 - S18051 Clamp
 - For use with compressed air



-
- V31** Constant Flow Breathing Tube Assembly for Hoods
- 20BT breathing tube
 - F31 1/4" Schrader quick-disconnect nipple
 - S18051 Clamp
 - For use with compressed air



-
- V32** Constant Flow Breathing Tube Assembly for Hoods
Same as V31 above with:
- F32 1/4" Snap-Tite steel quick-disconnect nipple



-
- V33** Constant Flow Breathing Tube Assembly for Hoods
Same as V32 above with:
- F33 1/4" Snap-Tite brass quick-disconnect nipple



-
- V34** Constant Flow Breathing Tube Assembly for Hoods
Same as V32 above with:
- F34 1/4" Snap-Tite stainless steel quick-disconnect nipple



RT Series Airline Respirator

RT Series Breathing Tube Replacement Parts

F30

Constant Flow Control Valve

- 1/4" industrial interchange (Hansen compatible) quick-disconnect nipple
- Threaded hose connector
- 4612 nylon belt
- Connects to 88VXBT, GVXBT, L99BT, 20BT, RTBT or 20LFBT
- For use with compressed air



F31

Constant Flow Control Valve

- 1/4" Schrader quick-disconnect nipple
- Threaded hose connector
- 4612 nylon belt
- Connects to 88VXBT, GVXBT, L99BT, 20BT, RTBT or 20LFBT
- For use with compressed air



F32

Constant Flow Control Valve

- 1/4" Snap-Tite steel quick-disconnect nipple
- Threaded hose connector
- 4612 nylon belt
- Connects to 88VXBT, GVXBT, L99BT, 20BT, RTBT or 20LFBT
- For use with compressed air



F33

Constant Flow Control Valve

- 1/4" Snap-Tite brass quick-disconnect nipple
- Threaded hose connector
- 4612 nylon belt
- Connects to 88VXBT, GVXBT, L99BT, 20BT, RTBT or 20LFBT
- For use with compressed air



F34

Constant Flow Control Valve

- 1/4" Snap-Tite stainless steel quick-disconnect nipple
- Threaded hose connector
- 4612 nylon belt
- Connects to 88VXBT, GVXBT, L99BT, 20BT, RTBT or 20LFBT
- For use with compressed air



RT Series Airline Respirator

RT Series Breathing Tube Replacement Parts

20BT	Breathing Tube for Hoods <ul style="list-style-type: none">• Nipple not included• S18051 clamp	
RTBT	Disposable Breathing Tube <ul style="list-style-type: none">• Nipple not included• S18051 clamp	
S18051	Breathing Tube Clamp <ul style="list-style-type: none">• 10 per package	
S18051BLACK	Breathing Tube Clamp, Black <ul style="list-style-type: none">• 10 per package	
4612	Nylon Belt	
36501	Vinyl Decon Belt	
20QCBTC 20SLBTC	Tychem® QC Breathing Tube Cover Tychem® SL Breathing Tube Cover <ul style="list-style-type: none">• Length 24.5"	
POLYBTC	Clear Poly Breathing Tube Cover Sleeve <ul style="list-style-type: none">• 100 per package• Length 38"	
RTLC	Adhesive-Edged Mylar® Lens Covers <ul style="list-style-type: none">• 25 per package	

Blasting and Grinding Respirators



What are Blasting and Grinding Respirators?

Bullard has been a leader in the abrasive blasting and grinding industry since the 1930s, when it developed the supplied air abrasive blasting respirator for the construction of the Golden Gate Bridge. Since then, Bullard has continued to develop respiratory protection products for not only abrasive blasters, but also industrial many other applications including grinding, painting, welding, and chemical handling.

Abrasive Blasting

Abrasive blasting respirators are defined as Type CE by NIOSH according to 42CFR84 as follows:

84.130 Supplied-air respirators; description.

(f) "Type "CE" supplied-air respirators. A type "C" supplied-air respirator equipped with additional devices designed to protect the wearer's head and neck against impact and abrasion from rebounding abrasive material, and with shielding material such as plastic, glass, woven wire, sheet metal, or other suitable material to protect the window(s) of facepieces, hoods and helmets which do not unduly interfere with the wearer's vision and permit easy access to the external surface of such window(s) for cleaning."

Both the 88VX and the GenVX™ are NIOSH approved as continuous flow Type C and Type CE abrasive blasting respirator, complete with a durable cape to protect the wearer's head and neck against abrasive rebound, as well as a durable helmet which meets the ANSI/ISEA Z98.1-2009, Type I, head protection standard requirements. The helmet has both an inner lens and an outer lens to meet the requirements of 42CFR.130 explained above. Both the GenVX™ and the 88VX have independent 3rd party data to support 1000 APF.

Grinding

Bullard was one of the first to offer a hood-style respirator designed specifically with grinding operations in mind. The GR50 is lightweight and fully protective with a Nomex® outer hood, flame retardant inner bib, and the ability to integrate a hard hat.

Solutions

Whether blasting or grinding, Bullard can provide the appropriate respiratory protection.



GenVX™ Series Airline Respirator

The Next Generation of Blasting.

The GenVX is the newest blasting helmet from Bullard, providing users with the industry's **lightest, coolest, most comfortable,** and **most dependable** helmet on the market for abrasive blasters and painters.

The GenVX Series airline respirators are approved by NIOSH (TC-19C-0489, TC-19C-0491, TC-19C-0492, TC-19C-0493, TC-19C-0494, TC-19C-0495, TC-19C-0496, Type C and CE) to provide respiratory protection in general purpose applications including heavy- and light-duty abrasive blasting, and Type C and CE painting applications.

Superior Protection

The GenVX offers superior protection to workers who are exposed to the harsh environments of blasting and painting. It is a full pound lighter than competitive products and offers the most cooling options for added comfort. Constructed from High-Density Polyethylene (HDPE) for superior strength, the sleek design of the GenVX allows air to pass directly over the user's head, providing greater air flow and improved cooling.

Exceptional Comfort

The helmet offers launderable, removable, and adjustable cheek pads for increased comfort and stability and a "Grit Guard" visor that keeps debris out of the lens. The GenVX is equipped with a six-point suspension, wide 1" straps for maximum comfort and a ratchet knob for easy adjustments. The center breathing tube connection provides greater balance to the user.

Dependable

Third-party 1,000 Assigned Protection Factor (APF) data and ANSI/ISEA Z89 Head Protection and High-Impact Z87+ Face Protection ratings make the GenVX the most dependable blast helmet available on the market.

Climate Control

Optional climate control assemblies permit workers to warm or cool incoming air to maximize comfort and improve productivity. Approved climate control models include CT, HCT, AC1000, HC2400, Frigatron, and Dual-Cool.

GenVX™



GenVX™ Series Airline Respirator

Technical Specifications			
Regulatory		Lens System	
Assigned Protection Factor (APF)	1,000 (third party tested)	Viewing area	4" x 9.75"
ANSI/ISEA Z89.1-2009, Type I, Class C		Inner lens	.040" Tritan™*
ANSI/ISEA Z87.1-2010, Z87+ High-Impact Face Protection		Outer lens	.015" PETG†
Helmet		Capes	
Material	High-density Polyethylene shell & door	8 oz. Nylon Denier	
Weight	2.39 lbs.	Continuous steel cable attachment	
Suspension		28" standard	
6-pt. Flex-Gear® Ratchet		Third hand for easy installation	
Adjustable to fit sizes 6.5-8			
1" wide nylon webbing			

* Impact- and chemical-resistant faceshield

† Other thicknesses and tints available

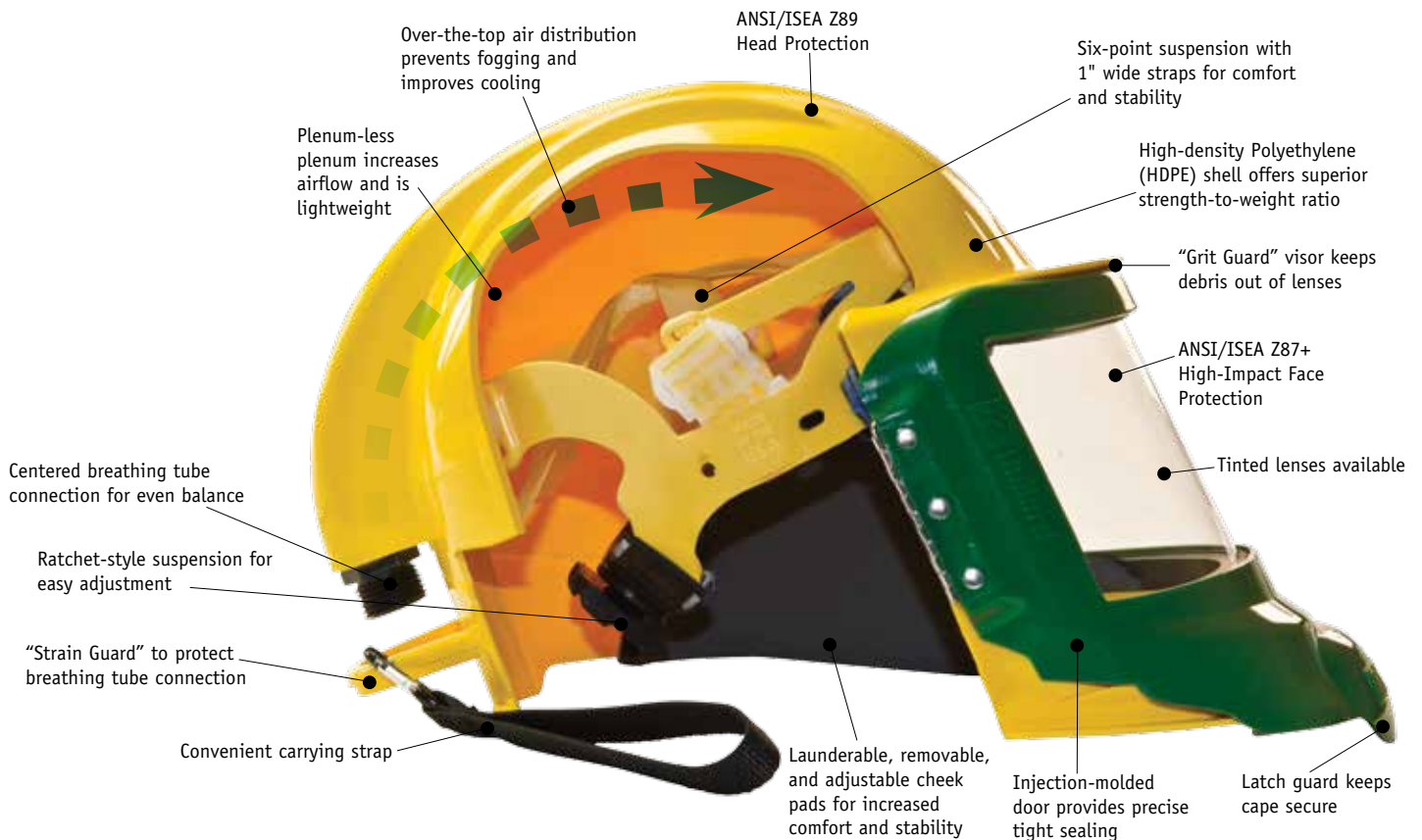

GenVX™ Series Airline Respirator

GenVX™ Series Airline Respirator Selection Chart

1. GenVX™ Hood



- **Oval Window**
(Standard)

2. Choose Suspension

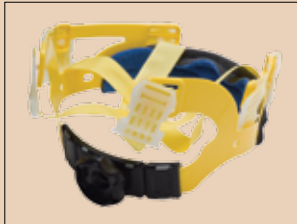

- **GVXRT & GVXPL** - Adjustable Flex-Gear® Ratchet Headband or Pinlock Suspension - Inner Shell/Air Plenum included

3. GenVX™ Breathing Tube

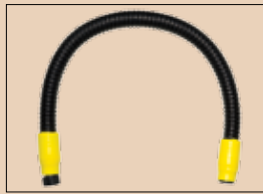

- **GVXBT** - Nipple not included

4. Choose Flow Control



- **F30, F30B, F30S** - Constant Flow Control Valve, 1/4" Industrial Interchange
- **F31** - Schrader
- **F32** - Snap-Tite Steel
- **F33** - Snap-Tite Brass
- **F34** - Snap-Tite Stainless
- **F37** - CEJN
- **F38** - Bayonet Steel



- **F35, F35B, for Free-Air® Pumps** - Constant Flow Control Valve, 1/2" Industrial Interchange

4. Choose Flow Control continued...

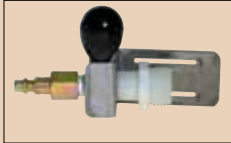

- **1/4" Adjustable Flow**
- **F40, F40B, F40S** - Industrial Interchange
- **F40** - Schrader
- **F41** - Schrader
- **F42** - Snap-Tite Steel
- **F43** - Snap-Tite Brass
- **F44** - Snap-Tite Stainless
- **F47** - CEJN
- **F48** - Bayonet Steel



- **Cool Tubes for Compressed Air (Metal)**
- **AC100030, AC100030B, AC100030S** - 1/4" Industrial Interchange
- **AC100031** - Schrader
- **AC100032** - Snap-Tite Steel
- **AC100033** - Snap-Tite Brass
- **AC100034** - Snap-Tite Stainless
- **AC100037** - CEJN
- **AC100038** - Bayonet Steel



- **Cool Tubes for Free-Air® Pumps (ADP20 and EDP30)**
- **FRIGITRON2000** 1/2" Industrial Interchange
- **FRIGITRON2000B** Brass



- **Cool Tubes for Compressed Air (Plastic)**
- **CT30, CT30B, CT30S** 1/4" Industrial Interchange
- **CT30SW, CT30BSW, CT30SSW** 1/4" Industrial Interchange with Dynaswivel fitting
- **CT31** - Schrader
- **CT32** - Snap-Tite Steel
- **CT33** - Snap-Tite Brass
- **CT34** - Snap-Tite Stainless
- **CT37** - CEJN
- **CT38** - Bayonet Steel



- **Hot/Cold Tubes for Compressed Air (Plastic)**
- **HCT30, HCT30B, HCT30S** 1/4" Industrial Interchange
- **HCT30SW, HCT30BSW, HCT30SSW** 1/4" Industrial Interchange with Dynaswivel fitting
- **HCT31** - Schrader
- **HCT32** - Snap-Tite Steel
- **HCT33** - Snap-Tite Brass
- **HCT34** - Snap-Tite Stainless
- **HCT37** - CEJN
- **HCT38** - Bayonet Steel



- **Hot/Cold Tubes for Compressed Air (Metal)**
- **HC2400, HC240030B, HC240030S** 1/4" Industrial Interchange
- **HC240031** - Schrader
- **HC240032** - Snap-Tite Steel
- **HC240033** - Snap-Tite Brass
- **HC240034** - Snap-Tite Stainless
- **HC240037** - CEJN
- **HC240038** - Bayonet Steel

5. Choose Cape



- **28VX** - 28" Nylon Cape
- **38VX** - 38" Nylon Cape



- **GGVX** - 38" "Golden Gate" Nylon Cape



- **PKVX** - 38" Nylon Parka
- **PKVXLVX** - 38" Nylon Parka

6. Choose Cooling Vest



- **DC70ML** - Med/Lg Cool Vest
- **DC70XLXXL** - XL/XXL Cool Vest
- **DC705XL** - 5XL Cool Vest



- **DC5040** - Dual-Cool Industrial Interchange
- **DC5041** - Dual-Cool Schrader
- **DC5042** - Dual-Cool Snap-Tite Steel
- **DC5044** - Dual-Cool Snap-Tite Stainless
- **DC5047** - Dual-Cool CEJN

7. Choose Belt and/or Accessories



- **4612** - Nylon Belt



- **GVXCS** - Chinstrap



- **GVXLC** - Adhesive Mylar® Lens Cover



- **GVXCP** - Cheek Pads, Pair

GenVX™ Series Airline Respirator

A complete GenVX™ Series Airline Respirator consists of the following three components:

1. Respirator Helmet and Cape
2. Breathing Tube with Fitting or Optional Climate Control Assembly
3. Breathing Air Supply Hose

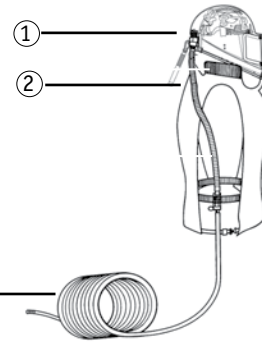

All three Bullard components must be present and properly assembled to constitute a NIOSH approved respirator.

Approval No. TC-19C-0489, TC-19C-0491, TC-19C-0492, TC-19C-0493, TC-19C-0494, TC-19C-0495, TC-19C-0496, TC-19C-0498, Type C and CE, Continuous Flow Class

GenVX™ Series Respirator Assemblies for use with Compressed Air

Respirators with 28VX Nylon Cape – 28" Length

- | | |
|----------------------|--|
| GVX2830 | F30 Constant Flow ¼" Industrial Interchange Fitting |
| GVX2830CT | CT30 Cool Tube ¼" Industrial Interchange Fitting |
| GVX2830AC1000 | AC1000 Cool Tube ¼" Industrial Interchange Fitting |
| GVX2830HCT | HCT30 Hot/Cold Tube ¼" Industrial Interchange Fitting |
| GVX2830HC2400 | HC2400 Hot/Cold Tube ¼" Industrial Interchange Fitting |
| GVX2840 | F40 Adjustable Flow ¼" Industrial Interchange Fitting |
| GVX2831CT | CT31 Cool Tube ¼" Schrader Fitting (package of five) |
| GVX2831AC1000 | AC100031 Cool Tube ¼" Schrader Fitting |

All systems above include:

- Breathing tube assembly
- Inner and outer lens with Mylar® lens cover (package of five)
- Chinstrap (GVXCS)



GVX2830

Respirators with 13VX Nylon Cape – 38" Length

- | | |
|----------------------|--|
| GVX1330 | F30 Constant Flow ¼" Industrial Interchange Fitting |
| GVX3830CT | CT30 Cool Tube ¼" Industrial Interchange Fitting |
| GVX3830AC1000 | AC1000 Cool Tube ¼" Industrial Interchange Fitting |
| GVX3830HCT | HCT30 Hot/Cold Tube ¼" Industrial Interchange Fitting |
| GVX3830HC2400 | HC2400 Hot/Cold Tube ¼" Industrial Interchange Fitting |
| GVX3840 | F40 Adjustable Flow ¼" Industrial Interchange Fitting |

All systems above include:

- Breathing tube assembly
- Inner and outer lens with Mylar® lens cover (package of five)
- Chinstrap (GVXCS)



GVX1330

Respirators with PKVX Hibernia Parka (Tan) – 38" Length

- | | |
|----------------------|--|
| GVX3830 | F30 Constant Flow ¼" Industrial Interchange Fitting |
| GVXPK30CT | CT30 Cool Tube ¼" Industrial Interchange Fitting |
| GVXPK30XLCT | GVX3830CT with Extra-Large Parka |
| GVXPK30AC1000 | AC1000 Cool Tube ¼" Industrial Interchange Fitting |
| GVXPK30HCT | HCT30 Hot/Cold Tube ¼" Industrial Interchange Fitting |
| GVXPK30HC2400 | HC2400 Hot/Cold Tube ¼" Industrial Interchange Fitting |
| GVXPK40 | F40 Adjustable Flow ¼" Industrial Interchange Fitting |

All systems above include:

- Breathing tube assembly
- Inner and outer lens with Mylar® lens cover (package of five)
- Chinstrap (GVXCS)



GVX3830



GenVX™ Series Airline Respirator

GenVX™ Series Respirator Assembly for use with Bullard Free-Air® Pumps

Complete Respirator Work System

GVXSYS GVX2835 Respirator with 46VX Nylon Cape - 28" length
ADP20 Free-Air® Pump
V2050ST Air Supply Hose
FRIGITRON2000 climate control device

GVXSYS16TE GVX2835 Respirator with 46VX Nylon Cape - 28" length
EDP16TE Free-Air® Pump
V2050ST Air Supply Hose
All systems above include:

- Breathing tube assembly
- Inner and outer lens with Mylar® lens cover (package of five)
- Chinstrap (20NC)



Respirators with 28VX Nylon Cape – 28" Length

GVX2835 F35 Constant Flow 1/2" Industrial Interchange Fitting
System Includes:

- Breathing tube assembly
- Inner and outer lens with Mylar® lens cover (package of five)
- Chinstrap (GVXCS)



GenVX™ Series Airline Respirator

GenVX™ Series Replacement Valves for Breathing Tube Assemblies for use with Compressed Air



F30

Constant Flow Control

- 1/4" Industrial Interchange (Hansen compatible) quick-disconnect nipple
- Threaded hose connector
- Connects to GVXBT, 88VXBT, L99BT, 20BT, or 20LFBT
- 4612 Nylon belt



F31

Constant Flow Control

- 1/4" Schrader quick-disconnect nipple
- Threaded hose connector
- Connects to GVXBT, 88VXBT, L99BT, 20BT, or 20LFBT
- 4612 Nylon belt



F32

Constant Flow Control

- 1/4" Snap-Tite steel quick-disconnect nipple
- Threaded hose connector
- Connects to GVXBT, 88VXBT, L99BT, 20BT, or 20LFBT
- 4612 Nylon belt



F33

Constant Flow Control

- 1/4" Snap-Tite brass quick-disconnect nipple
- Threaded hose connector
- Connects to GVXBT, 88VXBT, L99BT, 20BT, or 20LFBT
- 4612 Nylon belt

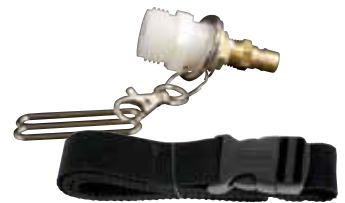

F37

Constant Flow Control

- 1/4" CEJN steel quick-disconnect nipple
- Threaded hose connector
- Connects to GVXBT, 88VXBT, 20BT, or 20LFBT
- 4612 Nylon belt



F38

Constant Flow Control Valve

- 1/4" Bayonet steel quick-disconnect nipple
- Threaded hose connector
- Connects to GVXBT or 88VXBT
- 4612 Nylon belt
- No ball bearings to "jam up" with grit



Blasting and Grinding

GenVX™ Series Airline Respirator

GenVX™ Series Replacement Valves for Breathing Tube Assemblies for use with Compressed Air

F40

Adjustable Flow Control

- 1/4" Industrial Interchange (Hansen Compatible) quick-disconnect nipple
- Threaded hose connector
- Connects to GVXBT, 88VXBT, 20BT, or 20LFBT
- 4612 Nylon belt

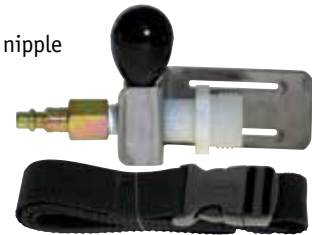

F41

Adjustable Flow Control

- 1/2" Schrader quick-disconnect nipple
- Threaded hose connector
- Connects to GVXBT, 88VXBT, 20BT, or 20LFBT
- 4612 Nylon belt



F42

Adjustable Flow Control

- 1/4" Snap-Tite steel quick-disconnect nipple
- Threaded hose connector
- Connects to GVXBT, 88VXBT, 20BT, or 20LFBT
- 4612 Nylon belt



F47

Adjustable Flow Control Valve

- 1/4" CEJN stainless steel quick-disconnect nipple
- Threaded hose connector
- Connects to GVXBT, 88VXBT, 20BT, or 20LFBT
- 4612 Nylon belt



GenVX™ Series Replacement Valves for Breathing Tube Assemblies for use with Bullard Free-Air® Pumps

F35

Constant Flow Control

- 1/2" Industrial Interchange (Hansen Compatible) quick-disconnect nipple
- Threaded hose connector
- Connects to GVXBT, 88VXBT, L99BT, 20BT, or 20LFBT
- 4612 Nylon belt

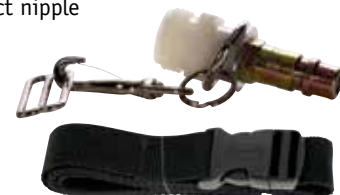

GenVX™ Series Airline Respirator

GenVX™ Series Replacement Parts for Breathing Tube Assemblies

Constant Flow Breathing Tube Assemblies - for use with compressed air

4612 Nylon Belt



GVXBT Breathing Tube
 • Flow control device not included



GVXCT Breathing Tube Connector Kit
 • Coupling Connector
 • Foam airline plug



GenVX™ Series Replacement Capes

28VX 28" Length Nylon Cape (Tan)
 • Includes snap hooks
 • Includes breathing tube straps
 • Includes additional nylon liner in neck cuff area
 • Includes 3rd hand tab assist for easy installation



38VX 38" Length Nylon Cape (Tan)
 • Includes snap hooks
 • Includes breathing tube straps
 • Includes additional nylon liner in neck cuff area
 • Includes 3rd hand tab assist for easy installation













GGVX 38" Length "Golden Gate" Nylon Cape (Tan)
 • Includes snap hooks
 • Includes breathing tube straps
 • Includes additional nylon liner in neck cuff area
 • Includes 3rd hand tab assist for easy installation



PKVX 38" Length Hibernia Parka (Tan)
PKXLVX 38" Length Hibernia Parka Extra-Large Size (Tan)
 • Includes snap hooks
 • Includes breathing tube straps
 • Includes additional nylon liner in neck cuff area
 • Includes 3rd hand tab assist for easy installation



GenVX™ Series Replacement Parts and Accessories

GVXRT	Adjustable Ratchet Six-Point Flex-Gear® Headband Suspension • Cotton Brow Pad	
GVXPL	Adjustable Pinlock Six-Point Headband Suspension • Cotton Brow Pad	
RBPCOTTON	Brow Pad • Large, absorbent cotton replacement brow pad • Fits all Bullard suspensions • Easy, Velcro® design	
RBPVINYL	Brow Pad • Vinyl replacement brow pad • Fits all Bullard suspensions • Easy, Velcro® design	
RBPCOOL	Brow Pad • Polartec replacement brow pad • Wicking material moves sweat away from the worker's brow • Fits all Bullard suspensions • Easy, Velcro® design	
GVXCS	Elastic Chinstrap • For use with GenVX™ Series only • 10 per package	
GVXCA	Replacement Carrying Strap	
GVXDMK	Maintenance Kit – Door/Gasket • Includes GenVX™ Series door with gasket, inner lens and hinge pin in a kit ready for mounting	
GVXHP	Replacement Hinge Pins for GenVX™ Door Frame • 10 per package	
GVXCP	Replacement Cheek Pads • One pair per package • Velcro® attachment straps included	

GenVX™ Series Replacement Parts and Accessories

GenVX™ Series Mylar® Lens

- GVXLC** Adhesive-backed Mylar® Lens Cover
- Clear
 - 25 per package



GenVX™ Series Replacement Lenses

Inner Lens

Tritan, For Use with GenVX™ Series

- GVXIL** Adhesive-backed Mylar® Lens Cover
- 25 per package
 - .040" thick



- BGVXIL** Adhesive-backed Mylar® Lens Cover
- Eight packages of 25
 - .040" thick



GenVX™ Series Replacement Lenses

Outer Lenses

PETG, For Use with GenVX™ Series

- GVXOL40**
- 25 per package
 - .040" thick



- BGVXOL40**
- Eight packages of 25
 - .040" thick

- GVXOL15**
- 50 per package
 - .015" thick



- BGVXOL15**
- Ten packages of 50
 - .015" thick

Tritan PETG, For Use with GenVX™ Series

- GVXOLT**
- 25 per package
 - Tinted Lens, Smoke
 - .030" thick



Smoke

- GVXOLG** Acetate, For Use with GenVX™ Series
- 25 per package
 - Tinted Lens, Green
 - .042" thick



Green



88VX Series Airline Respirator

Offering Outstanding Comfort and Reliability.

The Bullard 88VX Series airline respirators offer comfort and reliable respiratory protection for abrasive blasters and painters.

The 88VX Respirator is NIOSH approved as a Type C and CE Continuous Flow Class Respirator (Approval No. TC-19C-293).

Advanced Protection

88VX Series airline respirators provide advanced protection in the harsh exposures of blasting and painting. The snug, yet comfortable, sewn-in neck cuff provides a physical barrier to airborne contaminants and helps maintain positive pressure within the helmet. A new double lining in the neck area enhances durability and protection.

Comfortable Fit

A lightweight inner shell with an adjustable headband suspension holds the respirator firmly and comfortably on the wearer's head. Airflow is channeled directly to the user's breathing zone for easy breathing. The helmet easily accommodates beards, prescription eye wear, or safety glasses. No fit testing is required.

Head Protection

The helmet provides top impact and penetration protection ANSI Z89. The helmet and cape help protect the worker's entire head, face, and upper body from abrasive rebound, airborne contaminants, and messy overspray.

Climate Control

Optional climate control assemblies permit workers to warm or cool incoming air to maximize comfort and improve productivity. Approved climate control models include CT, HCT, AC1000, HC2400, Frigatron, and Dual-Cool.



88VX Series Airline Respirator

Features and Benefits

Injection-molded inner shell

Key slots for suspension are molded in the shell to provide a proper fit. The shell is also lightweight, compact, and portable.

Latch design on window frame and helmet

Strong, low profile provides tension on window and protection for the interior cape hook.

Forest green window frame gasket material

Durable, resistant to temperature variations, conforms to window frame. Easy to install into hood and replace inner lens.

Forest green window frame material

Flexible and durable with a gasket seal. Easy to install outer lens.

Breathing tube with flexible coating and forest green cuffs

Flexible and durable, reducing the amount of strain on the helmet and thus the user's neck.

Cape design with double lining above neck

Double lining enhances durability, comfort, and protection.

Latch position behind window frame

Reduces difficulty of attaching cape to helmet and prevents accidental opening.

Breathing tube positioning loops on back of cape to retain the breathing tube

Reduced snagging hazard on breathing tube.

Mylar® cover lens with new pull-tab design

Easier to pull off used cover lens.

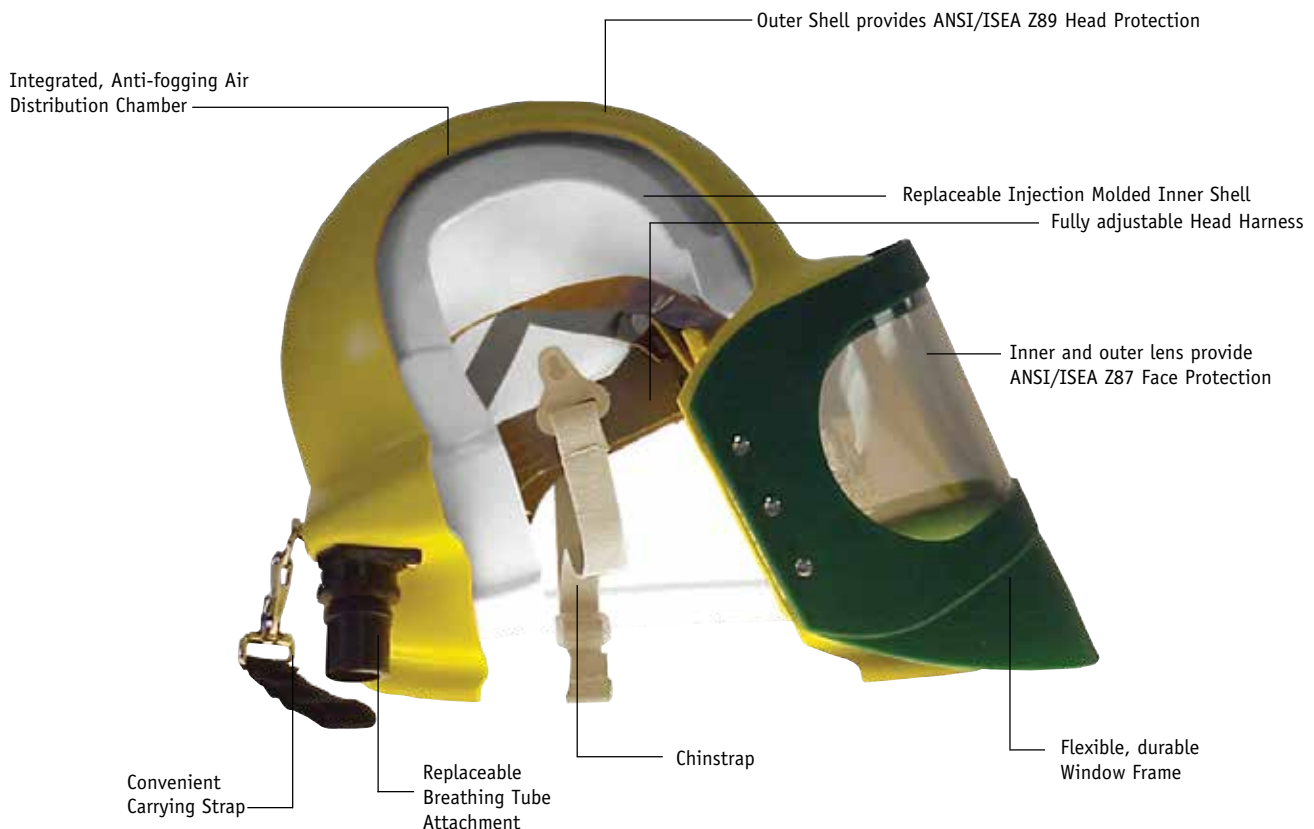

88VX Series Airline Respirator

88VX Series Airline Respirator Selection Chart

1. Choose Window Style (Helmet included)



• Oval Window
(Standard)



• Box Front
(Optional)

2. Choose Suspension



• **88VXRTP** - Adjustable Flex-Gear® Ratchet Headband Suspension - Inner Shell/Air Plenum included

3. Choose Breathing Tube



• **88VXBT** - Nipple not included

4. Choose Flow Control



• **F30, F30B, F30S** - Constant Flow Control Valve, 1/4" Industrial Interchange

- **F31** - Schrader
- **F32** - Snap-Tite Steel
- **F33** - Snap-Tite Brass
- **F34** - Snap-Tite Stainless
- **F37** - CEJN
- **F38** - Bayonet Steel



• **F35, F35B, for Free-Air® Pumps** - Constant Flow Control Valve, 1/2" Industrial Interchange

4. Choose Flow Control continued...

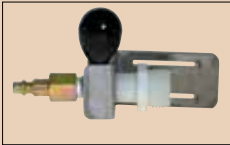

1/4" Adjustable Flow
• **F40, F40B, F40S** Industrial Interchange
• **F40** - Schrader
• **F41** - Schrader
• **F42** - Snap-Tite Steel
• **F43** - Snap-Tite Brass
• **F44** - Snap-Tite Stainless
• **F47** - CEJN
• **F48** - Bayonet Steel



Cool Tubes for Compressed Air (Metal)
• **AC100030, AC100030B, AC100030S** 1/4" Industrial Interchange
• **AC100031** - Schrader
• **AC100032** - Snap-Tite Steel
• **AC100033** - Snap-Tite Brass
• **AC100034** - Snap-Tite Stainless
• **AC100037** - CEJN
• **AC100038** - Bayonet Steel



Cool Tubes for Free-Air® Pumps (ADP20 and EDP30)
• **FRIGITRON2000** - 1/2" Industrial Interchange
• **FRIGITRON2000B** Brass



Cool Tubes for Compressed Air (Plastic)
• **CT30, CT30B, CT30S** 1/4" Industrial Interchange
• **CT30SW, CT30BSW, CT30SSW** 1/4" Industrial Interchange with Dynaswivel fitting
• **CT31** - Schrader
• **CT32** - Snap-Tite Steel
• **CT33** - Snap-Tite Brass
• **CT34** - Snap-Tite Stainless
• **CT37** - CEJN
• **CT38** - Bayonet Steel



Hot/Cold Tubes for Compressed Air (Plastic)
• **HCT30, HCT30B, HCT30S** 1/4" Industrial Interchange
• **HCT30SW, HCT30BSW, HCT30SSW** 1/4" Industrial Interchange with Dynaswivel fitting
• **HCT31** - Schrader
• **HCT32** - Snap-Tite Steel
• **HCT33** - Snap-Tite Brass
• **HCT34** - Snap-Tite Stainless
• **HCT37** - CEJN
• **HCT38** - Bayonet Steel



Hot/Cold Tubes for Compressed Air (Metal)
• **HC2400, HC240030B, HC240030S** 1/4" Industrial Interchange
• **HC240031** - Schrader
• **HC240032** - Snap-Tite Steel
• **HC240033** - Snap-Tite Brass
• **HC240034** - Snap-Tite Stainless
• **HC240037** - CEJN
• **HC240038** - Bayonet Steel

5. Choose Cape



• **46VX** - 28" Nylon Cape
• **13VX** - 38" Nylon Cape



• **21821** - 38" "Golden Gate" Nylon Cape



• **36VX** - 38" Nylon Parka
• **36XLVX** - 38" XL Nylon Parka

6. Choose Cooling Vest



• **DC70ML** - Med/Lg Cool Vest
• **DC70XLXXL** - XL/XXL Cool Vest
• **DC705XL** - 5XL Cool Vest



• **DC5040** - Dual-Cool Industrial Interchange
• **DC5041** - Dual-Cool Schrader
• **DC5042** - Dual-Cool Snap-Tite Steel
• **DC5044** - Dual-Cool Snap-Tite Stainless
• **DC5047** - Dual-Cool CEJN

7. Choose Belt and/or Accessories



• **4612** - Nylon Belt



• **20NC** - Chinstrap



• **7714** - Adhesive Backed Lens Cover



• **88VXLC** - Perforated Lens Covers

88VX Series Airline Respirator

A complete 88VX Series Airline Respirator consists of the following three components:

1. Respirator Helmet and Cape
2. Breathing Tube with Fitting or Optional Climate Control Assembly
3. Breathing Air Supply Hose

All three Bullard components must be present and properly assembled to constitute a NIOSH approved respirator.

Approval No. TC-19C-293, Type C and CE, Continuous Flow Class

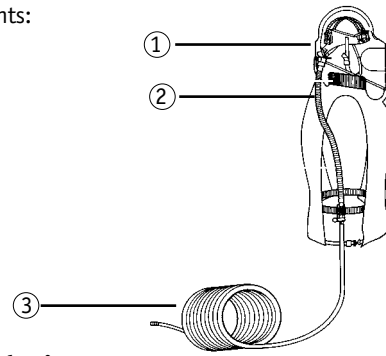

88VX Series Respirator Assemblies for use with Compressed Air

Respirators with 46VX Nylon Cape - 28" Length

-  **88VX3230** F30 Constant Flow 1/4" Industrial Interchange Fitting
 - 88VX3240** F40 Adjustable Flow 1/4" Industrial Interchange Fitting
 - 88VX3230H** F30 Constant Flow 1/4" Industrial Interchange Fitting with 4696 Starter Hose 25'
 - 88VX3231** F31 Constant Flow 1/4" Schrader Fitting
- All systems above include:
- Breathing tube assembly
 - Inner and outer lens with Mylar® lens cover (package of five)
 - Chinstrap (20NC)



88VX3230

 Best Seller

Respirators with 13VX Nylon Cape - 38" Length

- 88VX1330** F30 Constant Flow 1/4" Industrial Interchange Fitting

- System above includes:
- Breathing tube assembly
 - Inner and outer lens with Mylar® lens cover (package of five)
 - Chinstrap (20NC)



88VX Series Airline Respirator

88VX Series Respirator Assemblies for Use with Compressed Air

Respirators with 36VX Hibernia Parka (Tan) - 38" length

88VX3630 F30 Constant Flow 1/4" Industrial Interchange Fitting
88VX36XL30 88VX3630 with Extra-Large Parka

All systems above include:

- Breathing tube assembly
- Inner and outer lens with Mylar® lens cover (package of five)
- Chinstrap (20NC)



88VX Series Respirator Assemblies for use with Bullard Free-Air® Pumps

Complete Respirator Work System

88VXSYS 88VX3235 Respirator with 46VX Nylon Cape - 28" length
ADP20 Free-Air® Pump
V2050ST Air Supply Hose
FRIGITRON2000 climate control device

88VXSYS16TE 88VX3235 Respirator with 46VX Nylon Cape - 28" length
EDP16TE Free-Air® Pump
V2050ST Air Supply Hose

All systems above include:

- Breathing tube assembly
- Inner and outer lens with Mylar® lens cover (package of five)
- Chinstrap (20NC)



88VXSYS

Respirators with 46VX Nylon Cape - 28" length

88VX3235 F35 Constant Flow 1/2" Industrial Interchange Fitting
88VX3235H100 F35 Constant Flow 1/2" Industrial Interchange Fitting with
V20100ST Supply Hose, 100'

All systems above include:

- Breathing tube assembly
- Inner and outer lens with Mylar® lens cover (package of five)
- Chinstrap (20NC)

Respirators with 13VX Nylon Cape - 38" length

88VX1335 F35 Constant Flow 1/2" Industrial Interchange Fitting

System above includes:

- Breathing tube assembly
- Inner and outer lens with Mylar® lens cover (package of five)
- Chinstrap (20NC)



88VX3235

88VX Series Airline Respirator

88VX Breathing Tube Assemblies

Constant Flow Breathing Tube Assemblies - for use with compressed air

- EVX30** F30 1/4" Industrial Interchange (Hansen compatible) quick-disconnect nipple
- EVX31** F31 1/4" Schrader quick-disconnect nipple
- EVX32** F32 1/4" Snap-Tite Steel quick-disconnect nipple
- EVX33** F33 1/4" Snap-Tite Brass quick-disconnect nipple
- EVX37** F37 1/4" CEJN quick-disconnect nipple
- EVX38** F38 1/4" Bayonet quick-disconnect nipple

All above include:

- 88VXBT breathing tube
- 4612 nylon belt



EVX30

Adjustable Flow Breathing Tube Assemblies - for use with compressed air

- EVX40** F40 1/4" Industrial Interchange (Hansen compatible) quick-disconnect nipple
- EVX41** F41 1/4" Schrader quick-disconnect nipple
- EVX42** F42 1/4" Snap-Tite Steel quick-disconnect nipple
- EVX43** F43 1/4" Snap-Tite Brass quick-disconnect nipple
- EVX47** F47 1/4" CEJN quick-disconnect nipple
- EVX48** F48 1/4" Bayonet quick-disconnect nipple

All above include:

- 88VXBT breathing tube
- 4612 nylon belt



EVX40

Constant Flow Breathing Tube Assembly - for use with Bullard Free-Air® Pump

- EVX35** F35 1/4" Industrial Interchange (Hansen compatible) quick-disconnect nipple

All above include:

- 88VXBT breathing tube
- 4612 nylon belt



88VX Series Airline Respirator

88VX Series Replacement Valves for Breathing Tube Assemblies for use with Compressed Air

F30

Constant Flow Control

- 1/4" Industrial Interchange (Hansen compatible) quick-disconnect nipple
- Threaded hose connector
- Connects to 88VXBT, GVXBT, L99BT, 20BT, or 20LFBT
- 4612 Nylon belt



F31

Constant Flow Control

- 1/4" Schrader quick-disconnect nipple
- Threaded hose connector
- Connects to 88VXBT, GVXBT, L99BT, 20BT, or 20LFBT
- 4612 Nylon belt



F32

Constant Flow Control

- 1/4" Snap-Tite steel quick-disconnect nipple
- Threaded hose connector
- Connects to 88VXBT, GVXBT, L99BT, 20BT, or 20LFBT
- 4612 Nylon belt



F33

Constant Flow Control

- 1/4" Snap-Tite brass quick-disconnect nipple
- Threaded hose connector
- Connects to 88VXBT, GVXBT, L99BT, 20BT or 20LFBT
- 4612 Nylon belt



F37

Constant Flow Control

- 1/4" CEJN steel quick-disconnect nipple
- Threaded hose connector
- Connects to 88VXBT, GVXBT, 20BT, or 20LFBT
- 4612 Nylon belt



F38

Constant Flow Control Valve

- 1/4" Bayonet steel quick-disconnect nipple
- Threaded hose connector
- Connects to 88VXBT or GVXBT
- 4612 Nylon belt
- No ball bearings to "jam up" with grit



88VX Series Airline Respirator

88VX Series Replacement Valves for Breathing Tube Assemblies for use with Compressed Air

F40

Adjustable Flow Control

- 1/4" Industrial Interchange (Hansen Compatible) quick-disconnect nipple
- Threaded hose connector
- Connects to 88VXBT, GVXBT, 20BT, or 20LFBT
- 4612 Nylon belt

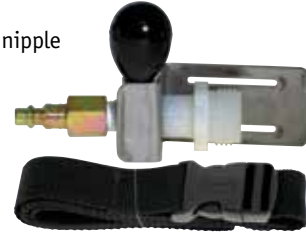

F41

Adjustable Flow Control

- 1/2" Schrader quick-disconnect nipple
- Threaded hose connector
- Connects to 88VXBT, GVXBT, 20BT, or 20LFBT
- 4612 Nylon belt



F42

Adjustable Flow Control

- 1/4" Snap-Tite steel quick-disconnect nipple
- Threaded hose connector
- Connects to 88VXBT, GVXBT, 20BT, or 20LFBT
- 4612 Nylon belt



F47

Adjustable Flow Control Valve

- 1/4" CEJN stainless steel quick-disconnect nipple
- Threaded hose connector
- Connects to 88VXBT, GVXBT, 20BT, or 20LFBT
- 4612 Nylon belt

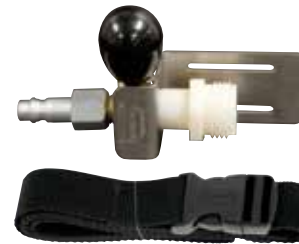

88VX Series Replacement Valves for Breathing Tube Assemblies for use with Bullard Free-Air® Pumps

F35

Constant Flow Control

- 1/2" Industrial Interchange (Hansen Compatible) quick-disconnect nipple
- Threaded hose connector
- Connects to 88VXBT, GVXBT, L99BT, 20BT, or 20LFBT
- 4612 Nylon belt

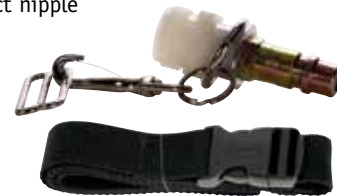

88VX Series Airline Respirator

88VX Series Replacement Parts for Breathing Tube Assemblies

4612 Nylon Belt



88VXBT Breathing Tube
• Nipple not included



88CK Breathing Tube Connector Kit
• Connector with sleeve
• Hardware
• Gasket
• "O" ring



88VX Series Airline Respirator

88VX Series Replacement Capes



46VX

28" Length Nylon Cape (Tan)

- Includes snap hooks
- Includes breathing tube straps
- Includes additional nylon liner in neck cuff area



Best Seller

13VX

38" Length Nylon Cape (Tan)

- Includes snap hooks
- Includes breathing tube straps
- Includes additional nylon liner in neck cuff area



21821

38" Length "Golden Gate" Nylon Cape (Tan)

- Cut-off cap sleeves
- Includes cinch straps/fabric ties
- Includes breathing tube straps
- Includes additional nylon liner in neck cuff area



36VX

38" Length Hibernia Parka (Tan)

36XLVX

38" Length Hibernia Parka Extra-Large Size (Tan)

- Nylon cape with long sleeves
- Includes belt straps
- Includes breathing tube straps
- Includes additional nylon liner in neck cuff area



Blasting and Grinding

88VX Series Airline Respirator

88VX Series Replacement Parts and Accessories

- 88VXRT** Adjustable Ratchet Headband Suspension - Inner Shell/Air Plenum Included
- Poly brow pad
 - Flex-Gear®



-
- RBPCOTTON** Brow Pad
- Large, absorbent cotton replacement brow pad
 - Fits all Bullard suspensions
 - Easy, Velcro® design



-
- RBPVINYL** Brow Pad
- Vinyl replacement brow pad
 - Fits all Bullard suspensions
 - Easy, Velcro® design



-
- RBPCOOL** Brow Pad
- Polartec replacement brow pad
 - Wicking material moves sweat away from the worker's brow
 - Fits all Bullard suspensions
 - Easy, Velcro® design



-
- 20NC** Elastic Chinstrap
- For 88VX, 20TG, and 20RT suspensions
 - 10 per package





88VX Series Airline Respirator

88VX Series Replacement Parts and Accessories

88CS Elastic Chinstrap

- For use with older model 88/88VX with riveted key hanger
- 10 per package
- latex-free



88CA Replacement Carrying Strap



88VXAK Maintenance Kit - Door/Gasket/Latch Assembly

- Includes 88VX Series door with latch, gasket, inner lens, bail, and hinge pin in a pre-assembled kit ready for mounting



88VXBAIL Replacement Bail for Latch Assembly

- 10 per package



88VXHP Replacement Hinge Pins for Latch Assembly

- 10 per package



GVXCP Replacement Cheek Pads for 88VX

- One pair per package
- Velcro® attachment straps included



88VX Series Airline Respirator

88VX Series Replacement Parts and Accessories

-
- BFW** Box Front Window Frame
- Accommodates rectangular glass lens (77GLT)
 - Catch, bail and hinge pin in a pre-assembled kit; ready for mounting



-
- 77GLT** Box Front Glass Lens
- For use with 77BFW and BFW



-
- 77LG** Box Front Lens Gasket
- For use with 77BFW and BFW

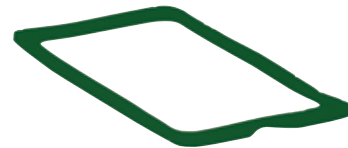

-
- G7713** 88VX Window Frame Gasket
- Oval gasket

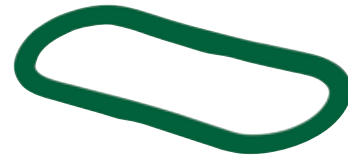

88VX Series Mylar® Lens

-
- 7714** Adhesive-backed Mylar® Lens Cover
- Clear
 - Rectangular
 - 25 per package



Perforated Edge Mylar® Lens Cover

-
- 88VXLC** • Clear
• 25 per package
- B88VXLC** • Clear
• 10 packages of 25



88VX Series Airline Respirator

88VX Series Replacement Lenses

Inner Lens

Tritan™, For Use with 77/88 Series

- MP771B** • 15 per package
- P771B** • 25 per package
- B771B** • Eight packages of 25 lenses
 - Oval
 - .040" thick



Outer Lens

Acetate, For Use with 77/88 Series

- B771040** • Eight packages of 25 lenses
 - Oval
 - .040" thick



PETG, For Use with 77/88 Series

- MP771020** • 15 per package
- P771020** • 50 per package
- B771020** • 8 packages of 50 lenses
 - Oval
 - .020" thick



- B771R** • 50 packs of 10 each
- P771R** • 50 per package
- B771R015** • 10 packages of 50 lenses
 - Rectangular
 - .015" thick



- B771D015** • 10 packages of 50 lenses
 - Rectangular
 - .015" thick
 - Protective film on both sides of lens



PETG, For Use with 88VX Series

- B771R020** • Seven packages of 50 lenses
 - Rectangular
 - .020" thick



Tritan PETG, For Use with 88VX Series

- 88VXOLT** • 25 per package
 - Tinted Lens, Smoke
 - .030" thick



Acetate, For Use with 88VX Series

- 88VXOLTG** • 25 per package
 - Tinted Lens, Green
 - .042" thick



GR50 Series Airline Respirator

Enhanced Comfort and Protection for Grinding Operations

Offering both respiratory and dermal protection, the Bullard GR50 is the first hood-style airline respirator designed especially to meet the challenges that are encountered in grinding operations. The lightweight outer hood, made from Dupont™ Nomex®, protects the operator's entire head, face, and neck from sparks and airborne particulates. The inner bib, made from flame-retardant cotton, is an added protective barrier. Applications in which the GR50 airline respirator can be used include grinding and metalworking.

For workers who use compressed breathing air, the Bullard GR50 is complete with Nomex respirator hood, breathing tube, and a choice of belt-mounted airline quick-disconnect fittings. The GR50 can also be used with convenient and low-cost Bullard Free-Air® pumps. Bullard V10 and V20 air supply hoses, sold separately, are available with point-of-attachment fittings for breathing air compressor systems or ambient air pumps.

Breathing Protection

Continuous airflow is delivered through a unique neck cuff, maintaining positive pressure inside the hood to help keep contaminants out.

Comfortable and Durable

Weighing only 12 oz. (340 g), the GR50 from Bullard is a lightweight alternative for workers accustomed to wearing heavier helmet-type respirators during grinding.

Head Protection and Climate Control Options

When worn with a Bullard hard hat, the hood meets ANSI/ISEA Z89.1-2009, Type I, requirements for protective headwear. A variety of climate control devices allow workers to cool or heat incoming air to meet their comfort requirements, helping to boost productivity.

Flexible Hood and Window

For operations performed in tight spaces, the flexible hood and window enhance worker mobility. The inner window is made of .040" polycarbonate so it stands up to temperatures of up to 300° F.

No Fit-Testing

One size fits all, so fit-testing is not required. The hood easily accommodates beards, hearing protection, prescription eyewear, or safety glasses.

Maximum Visibility

Wide-angle faceshield and headband suspension system are positioned to create the maximum viewing area. Replacement outer lens helps protect inner lens from sparks and debris, extending the usable life of the product.



GR50 Series Airline Respirator

GR50 Series Airline Respirator Selection Chart

1. Choose Head Top



•GRH - Nomex® Grinding Hood



•20RT - Adjustable Ratchet Headband Suspension



•C30P - Self-Sizing 6-point Pinlock Suspension, Full-Profile
•C30R - 6-point Flex-Gear® Ratchet Suspension



•S51P - Self-Sizing 4-point Pinlock Suspension, Low-Profile
•S51R - 4-point Flex-Gear® Ratchet Suspension

3. Choose Breathing Tube



•20BT - Breathing Tube for Hoods

4. Choose Flow Control Device



1/4" Continuous Flow
•F30, F30B, F30S Industrial Interchange
•F31 - Schrader
•F32 - Snap-Tite Steel
•F33 - Snap-Tite Brass
•F34 - Snap-Tite Stainless
•F35, F35B - 1/2" Industrial Interchange for Free-Air® Pumps
•F37 - CEJN

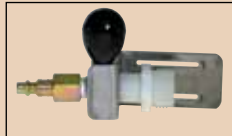

1/4" Adjustable Flow
•F40, F40B, F40S Industrial Interchange
•F41 - Schrader
•F42 - Snap-Tite Steel
•F43 - Snap-Tite Brass
•F44 - Snap-Tite Stainless
•F47 - CEJN



Cool Tubes for Compressed Air
•AC100030, AC100030B, AC100030S 1/4" Industrial Interchange
•AC100031 - Schrader
•AC100032 - Snap-Tite Steel
•AC100033 - Snap-Tite Brass
•AC100034 - Snap-Tite Stainless
•AC100037 - CEJN



Cool Tubes for Free-Air® Pumps
•FRIGITRON2000 1/2" Industrial Interchange
•FRIGITRON2000B - Brass



Hot/Cold Tubes
•HC240030, HC240030B, HC240030S 1/4" Industrial Interchange
•HC240031 - Schrader
•HC240032 - Snap-Tite Steel
•HC240033 - Snap-Tite Brass
•HC240034 - Snap-Tite Stainless
•HC240037 - CEJN

5. Choose Cooling Vest



•DC70ML - Med/Lg Cool Vest
•DC70LXXL - XL/XXL Cool Vest
•DC705XL - 5XL Cool Vest

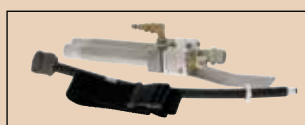

•DC5040 - Dual-Cool Industrial Interchange
•DC5041 - Dual-Cool Schrader
•DC5042 - Dual-Cool Snap-Tite Steel
•DC5047 - Dual-Cool CEJN

6. Choose Belt and/or Accessories



•4612 - Nylon Belt



•20NC - Chinstrap



•MB1 - PETG Outer Lens



•GRH01 - Polycarbonate Outer Lens

GR50 Airline Respirator

GR50 Airline Respirator Systems

Bullard's GR50 Airline Respirator consists of four components, all of which must be present and properly assembled to constitute a complete NIOSH approved respirator. Approval Number TC-19C-329, Type C.

1. Respirator Hood
2. Headband or Head Protection
3. Breathing Tube Assembly
4. Air Supply Hose

- Meets ANSI/ISEA Z89.1-2009 Head Protection Requirements when used with Bullard Hard Hats
- Meets ANSI/ISEA Z87.1-2010, Z87+ Face Protection Requirements (High Impact Penetration)

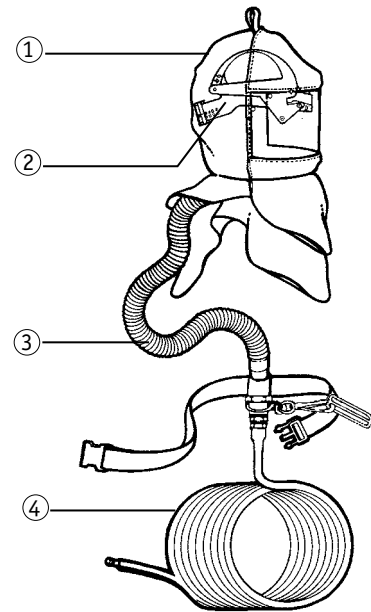

GR50SYS

GR50 Series Airline Respirator System

- GR5035 respirator assembly
- EDP10 Free-Air® pump
- V20100ST air supply hose



GR5035

Constant Flow Respirator with V35 Breathing Tube Assembly

- GRH hood
- 20RT suspension
- F35 1/2" industrial interchange (Hansen compatible) quick-disconnect nipple and nylon belt
- Outer lens
- For use with Bullard Free-Air® pumps



GR5030

Constant Flow Respirator with V30 Breathing Tube Assembly

- GRH hood
- 20RT suspension
- F30 1/4" Industrial Interchange (Hansen compatible) quick-disconnect nipple and nylon belt
- Outer lens
- For use with compressed air



GR50 Airline Respirator

GR50 Airline Respirator Replacement Respirator Hood

- GRH** Nomex Grinding Hood
- Includes outer lens
 - 12" long outer bib



GR50 Airline Respirator Replacement Parts

- 20RT** Adjustable Flex-Gear® Ratchet Headband Suspension
- Poly brow pad
 - Fits sizes 6½" to 8" (52-64 mm)



- 20TG** Adjustable Pinlock Headband Suspension
- Poly brow pad
 - Fits sizes 6½" to 8" (52-64 mm)

- 20NC** Elastic Chinstrap
- For 20TG, 20RT, and 88VX suspensions
 - 10 per package



- RBPCOTTON** Brow Pad
- Large, absorbent cotton replacement brow pad
 - Fits all Bullard suspensions
 - Easy, Velcro® design



- RBPVINYL** Brow Pad
- Vinyl replacement brow pad
 - Fits all Bullard suspensions
 - Easy, Velcro® design



- RBPCOOL** Brow pad
- Polartec replacement brow pad
 - Wicking material moves sweat away from the worker's brow
 - Fits all Bullard suspensions
 - Easy, Velcro® design



GR50 Airline Respirator

GR50 Head Protection

C30R

Hard Hat for use with 20TICH, 20SICH, GRH

- High-density polyethylene shell
- Full profile, wide brim
- Accessory slots for attachments
- 6-point Flex-Gear® ratchet suspension with large, absorbent cotton (RS6RC) brow pad
- Replacement brow pads available (RBPCOTTON, RBPVINYL, RBPCOOL)
- Meets or exceeds ANSI/ISEA Z89.1-2009, Type I, Class E & G requirements and CSA Z94.1-2005, Type 1, Class E & G requirements
- Case quantity: 20; minimum order: 20



S51R

Hard Hat for use with 20TICH, 20SICH, GRH

- High-density, polyethylene shell with flat front, low-profile design
- Accessory slots for cap attachments
- Rain trough brim
- 4-point Flex-Gear® ratchet suspension with poly (RS4RP) brow pad
- Replacement brow pads available (RBPCOTTON, RBPVINYL, RBPCOOL)
- Meets or exceeds ANSI/ISEA Z89.1-2009, Type I, Class E & G requirements and CSA Z94.1-2005, Type 1, Class E & G requirements, and EN 397:2012 requirements
- Case quantity: 20; minimum order: 20



GR50 Airline Respirator

GR50 Head Protection Replacement Parts

RS6RC

6-pt. Suspension

- 6-point Flex-Gear® ratchet suspension
- Large, absorbent cotton brow pad
- Replacement brow pads available (RBPCOTTON, RBPVINYL, RBPCOOL)
- Flex-points and nape cushion
- Large, easy-to-turn ratchet knob
- Vertical height adjustments (two front, three rear)
- For Models C30, C33, and C34

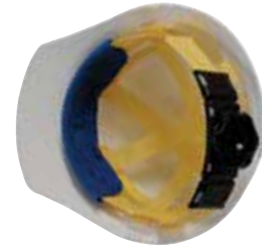

RS4RC

4-pt. Suspension

- 4-point Flex-Gear® ratchet suspension
- Large, absorbent cotton brow pad
- Replacement brow pads available (RBPCOTTON, RBPVINYL, RBPCOOL)
- Flex-points and nape cushion
- Large, easy-to-turn ratchet knob
- For Models S51, S61, S62, and S71



ES42







2-Point Elastic Chinstrap, Natural

- Latex-free, natural elastic
- For Models S51, S61, S62, S71, C30, C33, C34, 911C, 911H, and Bump Cap



GR50 Airline Respirator

GR50 Airline Respirator Breathing Tubes & Parts

V40	<p>Adjustable Flow Breathing Tube Assembly</p> <ul style="list-style-type: none">• 20BT breathing tube• F40 1/4" Industrial Interchange (Hansen compatible) quick-disconnect nipple with adjustable flow control valve• 4612 nylon belt• S18051 clamp• For use with compressed air	 A white corrugated breathing tube with a black nylon belt and a brass quick-disconnect nipple with an adjustable flow control valve.
V30	<p>Constant Flow Breathing Tube Assembly</p> <ul style="list-style-type: none">• 20BT breathing tube• F30 1/4" Industrial Interchange (Hansen compatible) quick-disconnect nipple• 4612 nylon belt• S18051 clamp• For use with compressed air	 A white corrugated breathing tube with a black nylon belt and a brass quick-disconnect nipple.
V35	<p>Constant Flow Breathing Tube Assembly</p> <ul style="list-style-type: none">• 20BT breathing tube• F35 1/2" Industrial Interchange (Hansen compatible) quick-disconnect nipple• 4612 nylon belt• S18051 clamp• For use with Bullard Free-Air® pumps	 A white corrugated breathing tube with a black nylon belt and a brass quick-disconnect nipple.
F30	<p>Constant Flow Control Valve</p> <ul style="list-style-type: none">• 1/4" Industrial Interchange (Hansen compatible) quick-disconnect nipple• Threaded hose connector• Connects to GVXBT, 88BT, L99BT, 20BT, or 20FLBT• 4612 nylon belt• For use with compressed air• F30B 1/4" Industrial Interchange, Brass• F30S 1/4" Industrial Interchange, Stainless	 A green plastic flow control valve with a metal quick-disconnect nipple and a black nylon belt.
F31	<p>Constant Flow Control Valve</p> <ul style="list-style-type: none">• 1/4" Industrial Interchange Schrader quick-disconnect nipple• Threaded hose connector• Connects to GVXBT, 88BT, L99BT, 20BT, or 20FLBT• 4612 nylon belt• For use with compressed air	 A green plastic flow control valve with a metal Schrader quick-disconnect nipple and a black nylon belt.
F32	<p>Constant Flow Control Valve</p> <ul style="list-style-type: none">• 1/4" Industrial Interchange Snap-Tite quick-disconnect nipple• Threaded hose connector• Connects to GVXBT, 88BT, L99BT, 20BT, or 20FLBT• 4612 nylon belt• For use with compressed air	 A green plastic flow control valve with a metal Snap-Tite quick-disconnect nipple and a black nylon belt.

GR50 Airline Respirator

GR50 Airline Respirator Breathing Tubes & Parts

F33

Constant Flow Control Valve

- 1/4" Industrial Interchange Snap-Tite, brass quick-disconnect nipple
- Threaded hose connector
- Connects to GVXBT, 88BT, L99BT, 20BT, or 20FLBT
- 4612 nylon belt
- For use with compressed air



F34

Constant Flow Control Valve

- 1/4" Industrial Interchange Snap-Tite, stainless quick-disconnect nipple
- Threaded hose connector
- Connects to GVXBT, 88BT, L99BT, 20BT, or 20FLBT
- 4612 nylon belt
- For use with compressed air



F37

Constant Flow Control Valve

- 1/4" Industrial Interchange CEJN quick-disconnect nipple
- Threaded hose connector
- Connects to GVXBT, 88BT, L99BT, 20BT, or 20FLBT
- 4612 nylon belt
- For use with compressed air



F40

Adjustable Flow Control Valve

- 1/4" Industrial Interchange (Hansen compatible) quick-disconnect nipple
- Threaded hose connector
- Connects to GVXBT, 88BT, L99BT, 20BT, or 20FLBT
- 4612 nylon belt
- For use with compressed air



F35

Constant Flow Control Valve

- 1/2" Industrial Interchange (Hansen compatible) quick-disconnect nipple
- Threaded hose connector
- Connects to GVXBT, 88BT, L99BT, 20BT, or 20FLBT
- 4612 nylon belt
- For use with Bullard Free-Air® pumps



GR50 Airline Respirator Replacement Parts & Accessories

20BT

Breathing Tube

- Nipple not included
- S18051 clamp



S18051

Breathing Tube Clamp

- 10 per package



GR50 Airline Respirator

GR50 Airline Respirator Replacement Parts & Accessories

S18051BLACK Breathing Tube Clamp, Black
• 10 per package



4612 Nylon Belt



MB1 PETG Outer Lens
• .020" thick
• 10 per package



GRHOL1 Polycarbonate Outer Lens
• .040" thick
• 10 per package



20LC Adhesive-Backed Mylar® Lens Cover
• Clear
• 25 per package



7714 Adhesive-Backed Mylar® Lens Cover
• Clear
• Rectangular
• 25 per package





Mask-Style Respirators Spectrum® Series

Comfort, Low Profile, Outstanding Visibility, Simplicity

Finally, there's a respirator that fits — your face, your needs, and your high expectations. Integrating intelligent features with innovative design, Bullard has moved respiratory protection to a whole new level. The Spectrum® Series offers outstanding comfort, low-profile fit, unparalleled visibility, simplicity, and 1,000 Assigned Protection Factor (APF).

With the addition of the Spectrum® Series, Bullard can meet all of a customer's airline respirator needs — from continuous flow hood and helmet airline respirators to tight-fitting facepiece airline/Escape Self-Contained Breathing Apparatus (ESCBAs) respirators. The four models in the Spectrum® Series include:

- Continuous flow
- Pressure demand
- Pressure demand with 5-minute cylinder
- Pressure demand with 10-minute cylinder

Spectrum® Protection

- NIOSH Approval TC-19C-322, TC-19C-354, TC-13F-387, TC-13F-388, TC-19C-321
- 1,000 Assigned Protection Factor (APF)
- ANSI/ISEA Z87.1-2010, Z87+ Impact Face Protection

Spectrum® Comfort

- Lightweight silicone flange seals softly against the user's face without feeling slippery
- Double flange provides a secure, comfortable fit across a wide range of facial sizes and contours

Spectrum® Low Profile

- Allows user to get close to their work
- Allows user to fit into tight quarters
- Reduces snag hazards
- Compatible with hard hat donning

Spectrum® Visibility

- Optically correct lens provides superior peripheral vision
- Clear nosecup allows more light into the mask, minimizing the closed-in feeling prevalent in other masks
- Mylar® Lens covers keep the lens clean and protected

Spectrum® Simplicity

- Snap-together parts make assembly and maintenance quick and efficient without requiring special tools
- A single facepiece platform design allows for conversion to other respirator configurations

Spectrum® Versatility

- The Spectrum® Full Face mask allows for multiple configurations:
 - PAPR (with the Bullard EVA)
 - Continuous Flow - Ambient Air Pump
 - Continuous Flow - Compressed Air
 - Pressure Demand - Compressed Air

Mask-Style Respirators Spectrum® Series Full-Facepiece

Features	Benefits
Low Profile	Fits under welding helmets
1,000 APF	100X the protection of APR Half Mask
Polycarbonate Lens	ANSI Z87+ Face Protection Great optics for clear vision
Silicone Straps & Flange Seals	Highest comfort
Nosecup	Improved Comfort Prevents Fogging Clear design for improved visibility
Speaker Diaphragm	Improved communication
Reusable	Low total cost of ownership
No Cartridges Required	Low total cost of ownership
PAPR SAR Continuous Flow SAR Pressure Demand SAR PD with Egress	Multiple configurations allow the user to buy a single platform for many applications

Applications

Painting and Coating Operations, Spray Foam Insulation, Remediation, Chemical Handling, Confined Space (with Escape bottle)



Mask-Style Respirators Spectrum® Series Full-Facepiece

Mask-Style Respirators Spectrum® Series Full-Facepiece

1. Choose Supplied Air Mode

Continuous Flow

Most popular configuration is SPEC40L (air supply hose not included)

Pressure Demand

Most popular configuration is SPECPDLA (air supply hose not included)

Pressure Demand with Escape Bottle

Most popular configuration is SPECPE10L (air supply hose not included)

2. Choose Mask Size



- SPECFFML - Medium/Large
- SPECFFS - Small



- SPECDFML - Medium/Large
- SPECDFS - Small



- SPECDFML - Medium/Large
- SPECDFS - Small

3. Choose Breathing Tube/Regulator Assembly



- BT100 - 1/4" Industrial Interchange Nipple
- BT101 - 1/4" Schrader Nipple
- BT102 - 1/4" Snap-Tite Nipple
- BT103 - 1/4" Snap-Tite Brass Nipple
- BT108 - 1/4" Bayonet Nipple
- BT135 - 1/2" Industrial Interchange Nipple



- PDR45 - Second stage regulator with Bypass including CA30 Industrial Interchange coupler
 - BHA - Belt/Harness Assembly
- Optional Couplers:**
- CA30 - 1/4" Industrial Interchange
 - CA31 - 1/4" Schrader
 - CA32 - 1/4" Snap-Tite
 - CA33 - 1/4" Snap-Tite Brass
 - CA34 - 1/4" Snap-Tite Stainless
 - CA37 - 1/4" CEJN

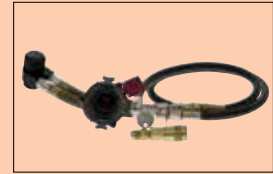

- RA45B - First and second regulator (with bypass) including CA30 Industrial Interchange coupler
 - BHA - Belt/Harness Assembly
- Optional Couplers:**
- CA30 - 1/4" Industrial Interchange
 - CA31 - 1/4" Schrader
 - CA32 - 1/4" Snap-Tite
 - CA33 - 1/4" Snap-Tite Brass
 - CA34 - 1/4" Snap-Tite Stainless
 - CA37 - 1/4" CEJN

4. Choose Escape Bottle



- CYL5H - 5 Minute



- CYL10H - 10 Minute

5. Choose Accessories



- PL - Spectacle Frame Assembly



- LC - Mylar® Lens Covers



- AFW45 - Anti-Fog Lens Wipes



- QNFT45 - Quantitative Fit Test Kit

6. Choose Air Supply Hose

- See pages 173-179

Spectrum® Series

Spectrum® Series Continuous Flow Replacement Parts

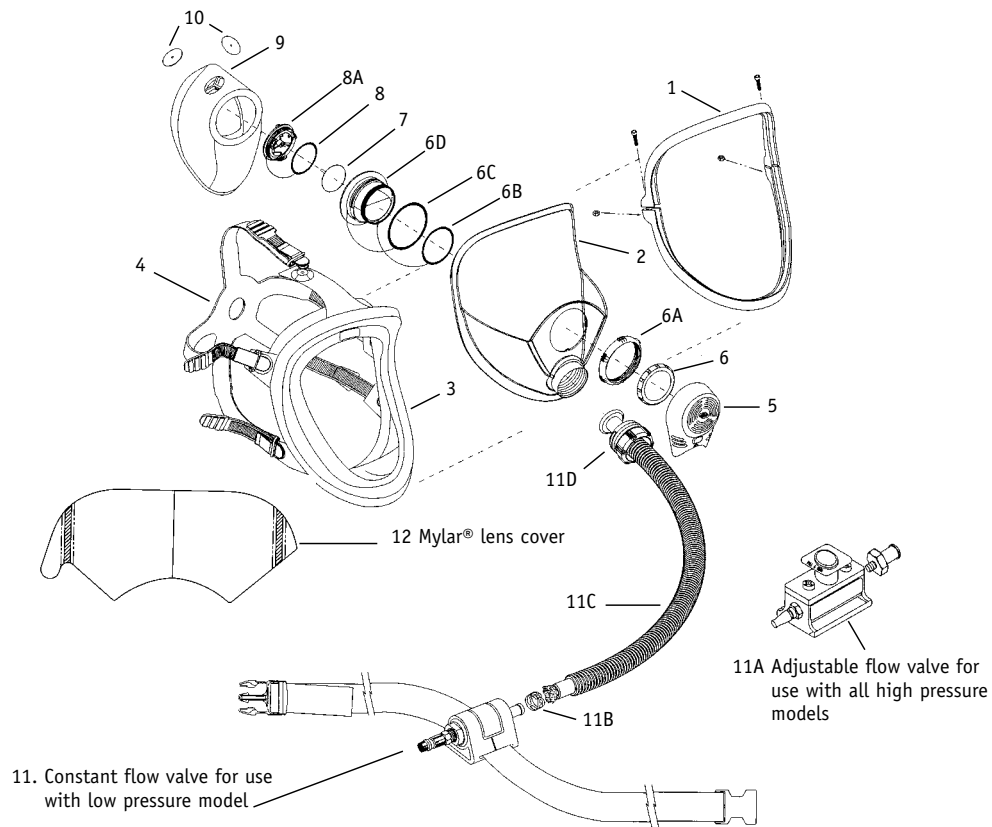

Cat. No.	Description	Cat. No.	Description
1. LCK	Lens Clamp Replacement	8. EVO (includes parts listed)	O-ring for Exhalation Valve Seat
2. RLS	Replacement Lens	8A	Exhalation Valve Seat
3. FKML & FKS	Facepiece Flange	9. LNK	Nose Cup
4. HSK	Headstrap with Buckles and Slides	10. SPECIVK	Inhalation Valve Flaps
5. MCK	Mask Cover	11. BTXXX (includes parts listed)	Breathing Tube Assembly
6. SEK (includes parts listed)	Speaker Diaphragm	11A	Flow Control Valve
6A	Outer Locking Ring	11B	Hose Clamp
6B	O-ring Speaker Diaphragm	11C	Breathing Tube
6C	O-ring Speaker/Exhalation	11D	Breathing Tube Adapter
6D	Speaker/Exhalation Body	12. LC	Mylar® Lens Covers
7. 6059	Exhalation Valve		

Spectrum® Series

Continuous Flow Airline Respirator

A complete Spectrum® Series Continuous Flow Airline Respirator consists of the following three components:

1. Full Facepiece
2. Breathing Tube Assembly
3. Breathing Air Supply Hose

All three Bullard components must be present and properly assembled to constitute a NIOSH approved respirator.

Approval No. TC-19C-322, Type C, Continuous Flow Class



SPECLSYS Spectrum® Series Airline Respirator System with Free-Air® Pump

- SPEC35L respirator assembly
- EDP10 Free-Air® pump
- V20100ST 100' air supply hose
- LC lens covers

SPECLSYS2M 2-Worker Spectrum® Airline Respirator System with Free-Air® Pump

- Same as above with additional SPEC35L and V20100ST 100' air supply hose

SPECLSYS50 Same as SPECLSYS, with V2050ST 50' air supply hose



SPECLSYS

SPECLCABSYS Spectrum® Series Airline Respirator System with Clean Air Box

- SPEC40L respirator assembly
- 15 cfm Clean Air Box
- 4696100 air supply hose
- LC lens covers
- Anti-fog wipes

SPECLCABSYS2M 2-Worker Spectrum® Airline Respirator System with Clean Air Box

- 2 SPEC40L Masks
- 30 cfm Clean Air Box
- 2 Breathing Tubes
- 2 4696100 Hoses
- LC lens covers
- Anti-fog wipes



SPECLCABSYS

Spectrum®-CF Respirator Assembly

SPEC40L SPECCFML Medium/Large Facepiece

SPEC40S SPECCFS Small Facepiece

- BT100 breathing tube assembly with 1/4" Industrial Interchange (Hansen compatible) nipple, adjustable flow control valve and nylon belt
- For use with compressed air



Spectrum®-CF Respirator Assembly for use with Bullard Free-Air® Pump

SPEC35L SPECCFML Medium/Large Facepiece

SPEC35S SPECCFS Small Facepiece

- BT135 breathing tube assembly with 1/2" Industrial Interchange (Hansen compatible) nipple and nylon belt
- For use with Bullard Free-Air® pumps



Spectrum® Series

Continuous Flow Breathing Tubes

- BT100** Adjustable Flow Breathing Tube Assembly - Industrial Interchange
- 1/4" Industrial Interchange with adjustable flow control valve (Hansen compatible) nipple
 - 4612 nylon belt
 - For use with compressed air



- BT101** Adjustable Flow Breathing Tube Assembly - Schrader
- 1/4" Schrader nipple with adjustable flow control valve
 - 4612 nylon belt
 - For use with compressed air



- BT102** Adjustable Flow Breathing Tube Assembly - Snap-Tite
- 1/4" Snap-Tite steel nipple with adjustable flow control valve
 - 4612 nylon belt
 - For use with compressed air



- BT103** Adjustable Flow Breathing Tube Assembly - Snap-Tite
- Same as BT102 except with brass nipple

- BT108** Adjustable Flow Breathing Tube Assembly
- 1/4" Bayonet steel nipple with adjustable flow control valve
 - 4612 nylon belt
 - For use with compressed air

- BT135** Constant Flow Breathing Tube Assembly - Industrial Interchange
- 1/2" Industrial Interchange (Hansen compatible) nipple
 - 4612 nylon belt
 - For use with Bullard Free-Air® pumps



Continuous Flow Facepieces

- SPECCFML** Medium/Large Facepiece Assembly
SPECCFS Small Facepiece Assembly
- Complete with facepiece, lens, head straps, exhalation valve, and facepiece components
 - For use only with SPEC-CF respirators



Spectrum® Series

Spectrum® Series Components

- RAK** Facepiece Components
- O-ring for regulator adapter
 - Regulator adapter
 - Lens port gasket
 - For use with SPEC-PD



- EVPDK** Exhalation Valve Kit
- Spring retainer
 - Spring
 - Plate
 - Exhalation valve flap and stem



- LNK** Replacement Nose Cup
- Includes 2 inhalation valve flaps



- RLS** Replacement Lens



Spectrum® Series

Spectrum® Series Pressure Demand Facepiece Components

LCK

- Lens Clamp Replacement Kit
- Upper and lower clamps
 - Screws and nuts



SPECIVK

- Inhalation Valve Kit
- Includes five inhalation valve flaps



FKML
FKS

- Medium/Large Facepiece Flange
Small Facepiece Flange



6059

- Exhalation Valve Kit
- **Continuous flow versions only**
 - Includes five exhalation valve flaps





Spectrum® Series

Spectrum® Series Continuous Flow Facepiece Components

HSK Headstrap Kit
• Includes 5 buckles and five slides



MCK Mask Cover
• Includes 5 inhalation valve flaps



SEK Speaker/Exhalation Kit
• Speaker/exhalation body
• Speaker diaphragm
• Outer locking ring
• O-ring for speaker diaphragm
• O-ring for speaker/exhalation body



EVO Exhalation Valve Seat and O-Ring



PL Spectacle Frame Assembly



LC Mylar® Lens Covers
• 25 per package



AFW45 Anti-Fog Lens Wipes
• 10 per package



Spectrum® Series

Spectrum® Series Fit Testing Accessories: Continuous Flow

QNFT45

Quantitative Fit Test Kit

- Fit test adapter
- Facepiece sampling adapter
- 1/8" barbed mask probe
- 1 HEPA filter cartridge



FTR45

Fit Test Refill Kit

- 15 feet of Tygon® tubing
- 25 suction cups and 25 clips



HFC45

Replacement HEPA Filter Cartridges

- For quantitative or qualitative fit testing (except for isoamyl acetate)
- 4 per carton



Spectrum® Series

Pressure Demand Airline Respirator

A complete Spectrum® Series Pressure Demand Airline Respirator consists of the following four components:

1. Full Facepiece
- 2a. Second Stage Regulator Assembly (PD Only)
- 2b. First and Second Stage Regulator Assembly (PDE Only)
- 3a. Harness Assembly
- 3b. Harness Assembly Including 5- or 10-minute Cylinder (PDE Only)
4. Air Supply Hose

All four Bullard components must be present and properly assembled to constitute a NIOSH approved respirator.

SPEC-PD Approval No. TC-19C-354, Type C, Pressure Demand Class

SPEC-PDE-5 Approval No. TC-13F-387, Combination SCBA and Type C Pressure Demand Class

SPEC-PDE-10 Approval No. TC-13F-388, Combination SCBA and Type C Pressure Demand Class



Spectrum®-PD Respirator Assembly

SPECPDLA SPECPDML Medium/Large Facepiece

SPECPDSA SPECPDML Small Facepiece

- PDR45 pressure demand regulator
- BHA belt harness assembly
- CA30 coupler assembly



Spectrum®-PDE5 Respirator Assembly

SPECPDE5L SPECPDML Medium/Large Facepiece

SPECPDE5S SPECPDS Small Facepiece

- RA45B regulator assembly (including 1st and 2nd stage regulators with bypass)
- Harness assembly (including 5-minute ESCBA cylinder)
- CA30 coupler assembly



Spectrum®-PDE10 Respirator Assembly

SPECPDE10L SPECPDML Medium/Large Facepiece

SPECPDE10S SPECPDS Small Facepiece

- RA45B regulator assembly (including 1st and 2nd stage regulators with bypass)
- Harness assembly (including 10-minute ESCBA cylinder)
- CA30 coupler assembly



Spectrum® Series

Spectrum® Series Pressure Demand Facepiece Replacement Parts

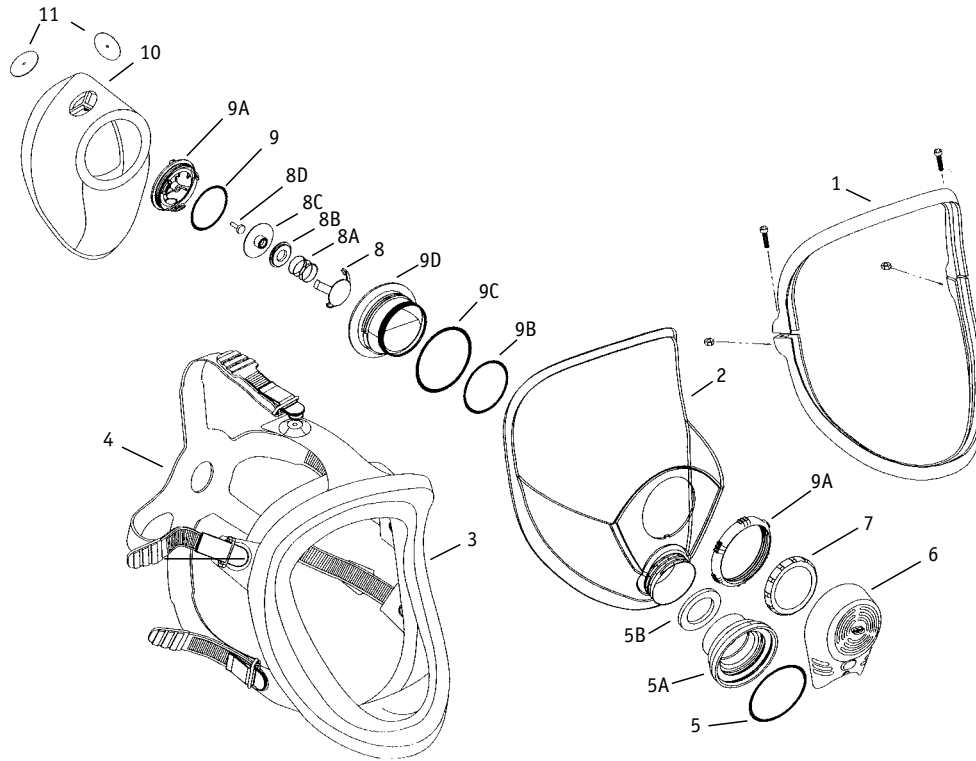

Cat. No.	Description	Cat. No.	Description
1. LCK	Lens Clamp	8. EVPDK (includes parts listed)	Spring Retainer
2. RLS	Replacement Lens	8A	Spring, PD
3. FKML & FKS	Facepiece Flange	8B	Plate
4. HSK	Headstrap with Buckles & Slides	8C	Exhalation Valve Flap
5. RAK (includes parts listed)	O-ring, Regulator Adapter	8D	Stem
5A	Regulator Adapter	9. EVO (includes parts listed)	O-ring for Exhalation Valve Seat
5B	Gasket, Lens Port	9A	Exhalation Valve Seat
6. MCK	Mask Cover	10. LNK	Nose Cup
7. SEK (includes parts listed)	Speaker Diaphragm	11. SPECIVK	Inhalation Valve Flap
7A	Outer Locking Ring		
7B	O-ring, Speaker Diaphragm		
7C	O-ring, Speaker/Exhalation		
7D	Speaker/Exhalation Body		

Spectrum® Series

Spectrum® Series Pressure Demand Regulators and Cylinders

- FSR45** First Stage Regulator
- Includes CA30 coupler assembly
 - For use only with SPEC-PDE respirators



- RA45B** First Stage Regulator and Second Stage Regulator with Bypass
- Includes CA30 coupler assembly
 - For use only with SPEC-PDE



- PDR45** Second Stage Regulator without Bypass
- Includes CA30 coupler assembly
 - For use only with SPEC-PD respirator



- PDR45B** Second Stage Regulator with Bypass
- Includes CA30 coupler assembly
 - For use only with SPEC-PDE



- CYL455** 5-Minute Escape Cylinder with Valve
- Additional shipping charges may apply



- CYL4510** 10-Minute Escape Cylinder with Valve
- Additional shipping charges may apply



- CYL5H** 5-Minute Escape Cylinder with Valve and Holster (shown)
- For use with SPEC-PDE5L
 - Additional shipping charges may apply



- CYL10H** 10-Minute Escape Cylinder with Valve and Holster
- For use with SPEC-PDE10L
 - Additional shipping charges may apply



Spectrum® Series

Spectrum® Series Pressure Demand Coupler Assemblies

- CA30** 1/4" Industrial Interchange, Brass, Quick-Disconnect Coupler Assembly
- Male threaded (Hansen compatible) nipple
 - Female threaded coupler with ball lock and adapter, which connects the respirator to the airline extension hose



- CA30S** 1/4" Industrial Interchange, Stainless, Quick-Disconnect Coupler Assembly
- Male threaded (Hansen compatible) nipple
 - Female threaded coupler with ball lock and adapter, which connects the respirator to the airline extension hose

-
- CA31** 1/4" Schrader Quick-Disconnect Coupler Assembly
- Male threaded nipple
 - Female threaded coupler with adapter, which connects the respirator to the airline extension hose



-
- CA32** 1/4" Snap-Tite Steel Quick-Disconnect Coupler Assembly
- Male threaded nipple
 - Female threaded coupler with adapter, which connects the respirator to the airline extension hose



-
- CA33** 1/4" Snap-Tite Brass Quick-Disconnect Coupler Assembly
- CA34** 1/4" Snap-Tite Stainless Steel Quick-Disconnect Coupler Assembly
- Male threaded nipple
 - Female threaded coupler with adapter, which connects the respirator to the airline extension hose



-
- CA37** 1/4" CEJN Steel Quick-Disconnect Coupler Assembly
- Male threaded nipple
 - Female threaded coupler with special orifice adapter, which connects the respirator to the airline extension hose
 - Use only with orifice adapter



Spectrum® Series

Spectrum® Series Pressure Demand Accessories

BHA

Replacement Shoulder Harness

- 4611 Fire Retardant nylon belt
- Buckle connector
- Shoulder strap



4611

Fire Retardant Nylon Belt



Mask-Style Respirators



Spectrum® Series

Spectrum® Series Components

- SPECPDML** Medium/Large Facepiece Assembly
SPECPDS Small Facepiece Assembly
- Complete with facepiece, lens, head straps, exhalation valve, and facepiece components
 - For use with SPEC-PD respirators



-
- RAK** Facepiece Components
- O-ring for regulator adapter
 - Regulator adapter
 - Lens port gasket
 - For use with SPEC-PD



-
- EVPDK** Exhalation Valve Kit
- Spring retainer
 - Spring
 - Plate
 - Exhalation valve flap and stem



-
- LNK** Replacement Nose Cup
- Includes 2 inhalation valve flaps



-
- RLS** Replacement Lens



Spectrum® Series

Spectrum® Series Pressure Demand Facepiece Components

- LCK** Lens Clamp Replacement Kit
- Upper and lower clamps
 - Screws and nuts



-
- SPECIVK** Inhalation Valve Kit
- Includes 5 inhalation valve flaps



-
- FKML** Medium/Large Facepiece Flange
FKS Small Facepiece Flange



Spectrum® Series

Spectrum® Series Facepiece Components

- HSK** Headstrap Kit
- Includes 5 buckles and five slides



-
- MCK** Mask Cover
- Includes 5 inhalation valve flaps



-
- SEK** Speaker/Exhalation Kit
- Speaker/exhalation body
 - Speaker diaphragm
 - Outer locking ring
 - O-ring for speaker diaphragm
 - O-ring for speaker/exhalation body



-
- EVO** Exhalation Valve Seat and O-Ring



-
- PL** Spectacle Frame Assembly



-
- LC** Mylar® Lens Covers
- 25 per package



-
- AFW45** Anti-Fog Lens Wipes
- 10 per package



Spectrum® Series

Spectrum® Series Fit Testing Accessories: Pressure Demand

QNFT45

Quantitative Fit Test Kit

- Fit test adapter
- Facepiece sampling adapter
- 1/8" barbed mask probe
- One HEPA filter cartridge



FTR45

Fit Test Refill Kit

- 15 feet of Tygon® tubing
- 25 suction cups and 25 clips



HFC45

Replacement HEPA Filter Cartridges

- For quantitative or qualitative fit testing (except for isoamyl acetate)
- 4 per carton



FAMB2 Half-Mask Airline Respirator

A Comfortable Positive Pressure Airline Respirator

The Bullard FAMB2 presents a simple means of supplying clean air to workers. Available with both pressure demand and continuous flow approvals, FAMB2 provides continuous airflow to workers operating in environments that are contaminated with dust, mists, gases, and vapors.

FAMB2 airline respirators are approved by NIOSH for use in Type C applications, including:

- Spray painting and coating operations
- Chemical and pesticide handling
- Wood finishing
- Welding

FAMB2 Comfort

The Bullard FAMB2 half-mask, available in three sizes, features a soft, flexible silicone facepiece that conforms to the worker's face. The double exhalation valve system offers minimal breathing resistance and reduces worker fatigue, increasing productivity.

Low Air Pressure Requirement

Specifically designed for use with low-pressure air sources such as Bullard Free-Air® pumps, the respirator operates efficiently at air pressures between 1.5 and 20 psig (103-138 kPa), depending on hose length. FAMB2 respirators are also approved for use with high-pressure air sources, such as breathing air compressors.

More Protection

The FAMB2 respirator provides a higher degree of protection than negative-pressure air-purifying respirators. Because FAMB2 is an airline respirator, there is no need to maintain or buy expensive filter cartridges.

Wide Field of Vision

The low-profile facepiece allows a wide field of vision and easily accommodates workers wearing prescription or safety glasses. FAMB2 can be worn under faceshields, visors, and welding helmets.



FAMB2 Series Half-Mask Airline Respirator

FAMB2 Half-Mask Airline Respirator System

A complete FAMB2 Series Airline Respirator consists of the following three components:

1. Half-Mask
2. Breathing Tube Assembly with Flow Control Device
3. Breathing Air Supply Hose

All three Bullard components must be present and properly assembled to constitute a NIOSH approved respirator.

Approval No. TC-19C-469, Type C, Continuous Flow Class - F30 and F35

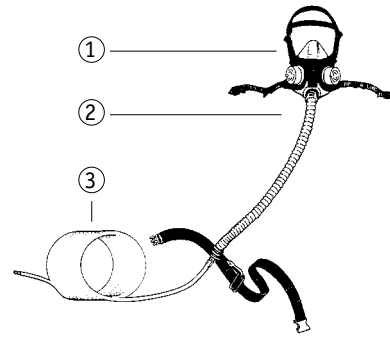

FAMBSYS FAMB2 Series Airline Respirator System

- FAMB235M respirator
- EDP10 Free-Air® Pump
- V20100ST 100' air supply hose



Half-Mask Respirator

- FAMB230S** Small Silicone Facepiece
- FAMB230M** Medium Silicone Facepiece
- FAMB230L** Large Silicone Facepiece

- Cradle suspension and breathing tube
- 1/4" Industrial Interchange (Hansen compatible) nipple and belt
- For use with compressed air



Half-Mask Respirator

- FAMB235S** Small Silicone Facepiece
- FAMB235M** Medium Silicone Facepiece
- FAMB235L** Large Silicone Facepiece

- Cradle suspension and breathing tube
- 1/2" Industrial Interchange (Hansen compatible) nipple and belt
- For use with Bullard Free-Air® Pumps



FAMB2 Half-Mask Airline Respirator

FAMB2 Series Half-Mask Respirator Components

- FAM2S** Small Half-Mask
- FAM2M** Medium Half-Mask
- FAM2L** Large Half-Mask
 - Silicone
 - Includes head straps



-
- FAM2CB** Cradle Headband Strap



-
- FAM2EVC2** Exhalation Valve Covers
 - 2 per package



-
- FAM2EVF10** Exhalation Valve
 - 10 per package





FAMB2 Half-Mask Airline Respirator

FAMB2 Series Half-Mask Fit Testing Accessories

- FAMAK** Fit Test Kit
- Includes Porta Count connector, sampling tube and (1) P100 filter



- PMFC2** P100 Filter Cartridges
- 1 per package



FAMB Series Half-Mask Breathing Tube Assemblies

- FAMB2T2C** Breathing Tube Assembly
- For use with FAMB235
 - Two nylon clamps (S18052)
 - 1/2" Industrial Interchange (Hansen compatible) quick-disconnect nipple
 - 4612 nylon belt
 - For use with Bullard Free-Air® Pumps



- FAMB2T3C** Breathing Tube Assembly
- For use with FAMB230
 - Two nylon clamps (S18052)
 - 1/4" Industrial Interchange (Hansen compatible) quick-disconnect nipple
 - 4612 nylon belt
 - For use with compressed air



- 4612** Nylon Belt



- 36501** Vinyl Decon Belt



Breathing Air Supply Hose

Bullard offers a variety of hoses and fittings to deliver breathable air to the worker from a clean air source.

V5 Series

Coiled hose is ideal for working at varying distances from a fixed air outlet. It is easily stretched and retracts immediately when released. Its self-storage principle ensures that the hose is kept off the floor and out of the way of the operator, improving both safety and cleanliness.

V10 Series

Bullard V10 Series hose is intended for use with compressed air and has an inside diameter of 3/8". Constructed of strong, yet flexible, EPDM rubber reinforced to prevent crushing or kinking, V10 Series hose is available in 25-, 50- and 100-foot sections configurable up to 300 feet in total length.

V20 Series

Bullard V20 Series hose is intended for use with Bullard Free-Air® Pumps and has an inside diameter of 1/2". Constructed of strong yet flexible EPDM rubber reinforced to prevent crushing or kinking, V20 Series hose is available in 50- and 100 foot sections configurable up to 300 feet in total length.

Fittings

Bullard offers five different types of fittings to ensure breathing air supply fittings are incompatible with fittings for non-breathing air gases such as nitrogen, natural gas, and argon. These fittings include:

- Industrial Interchange (Hansen)
- Schrader
- Snap-Tite
- CEJN
- Bayonet



Breathing Air Supply Hose

V5 Coiled Hose for Compressed Air

25-Foot Lengths

- V5KF2530XXX** V5 Industrial Interchange Hose, Kink-Free
- 1/4" Industrial Interchange (Hansen compatible) quick-disconnect coupler and nipple
 - For use with compressed air only. Not for use with Bullard Free-Air® pumps
 - For use with Bullard CC20, GR50, and RT Series respirators



Note: XXX denotes color. Red = RED; Blue = BLU; Black = BLK; Yellow = YLW

- V5KF2531XXX** V5 Schrader Hose, Kink-Free
- 1/4" Schrader quick-disconnect coupler and nipple
 - For use with compressed air only. Not for use with Bullard Free-Air® pumps
 - For use with Bullard CC20, GR50, and RT Series respirators

Note: XXX denotes color. Red = RED; Blue = BLU; Black = BLK; Yellow = YLW

- V5KF2532XXX** V5 Snap-Tite Hose, Kink-Free
- 1/4" Snap-Tite H-Series steel quick-disconnect coupler and nipple
 - For use with compressed air only. Not for use with Bullard Free-Air® pumps
 - For use with Bullard CC20, GR50, and RT Series respirators

Note: XXX denotes color. Red = RED; Blue = BLU; Black = BLK; Yellow = YLW

- V5KF2533XXX** V5 Snap-Tite (Brass) Hose, Kink-Free
- 1/4" Snap-Tite H-Series brass quick-disconnect coupler and nipple
 - For use with compressed air only. Not for use with Bullard Free-Air® pumps
 - For use with Bullard CC20, GR50, and RT Series respirators

Note: XXX denotes color. Red = RED; Blue = BLU; Black = BLK; Yellow = YLW

50-Foot Lengths

- V5KF5030XXX** V5 Industrial Interchange Hose, Kink-Free
- 1/4" Industrial Interchange (Hansen compatible) quick-disconnect coupler and nipple
 - For use with compressed air only. Not for use with Bullard Free-Air® pumps
 - For use with Bullard CC20, GR50, and RT Series respirators

Note: XXX denotes color. Red = RED; Blue = BLU; Black = BLK; Yellow = YLW

- V5KF5031XXX** V5 Schrader Hose, Kink-Free
- 1/4" Schrader quick-disconnect coupler and nipple
 - For use with compressed air only. Not for use with Bullard Free-Air® pumps
 - For use with Bullard CC20, GR50, and RT Series respirators

Note: XXX denotes color. Red = RED; Blue = BLU; Black = BLK; Yellow = YLW

- V5KF5032XXX** V5 Snap-Tite (Brass) Hose, Kink-Free
- 1/4" Snap-Tite H-Series steel quick-disconnect coupler and nipple
 - For use with compressed air only. Not for use with Bullard Free-Air® pumps
 - For use with Bullard CC20, GR50, and RT Series respirators

Note: XXX denotes color. Red = RED; Blue = BLU; Black = BLK; Yellow = YLW

- V5KF5033XXX** V5 Snap-Tite Hose, Kink-Free
- 1/4" Snap-Tite H-Series brass quick-disconnect coupler and nipple
 - For use with compressed air only. Not for use with Bullard Free-Air® pumps
 - For use with Bullard CC20, GR50, and RT Series respirators

Note: XXX denotes color. Red = RED; Blue = BLU; Black = BLK; Yellow = YLW

Breathing Air Supply Hose

V10 3/8" ID Heavy Duty Air Supply Hose for Compressed Air

*Not for use with Ambient Air Pumps or Bullard Free-Air® Pumps

For use with Bullard CC20, RT, GR50, Spectrum®, 88VX, and GenVX™ Series Respirators

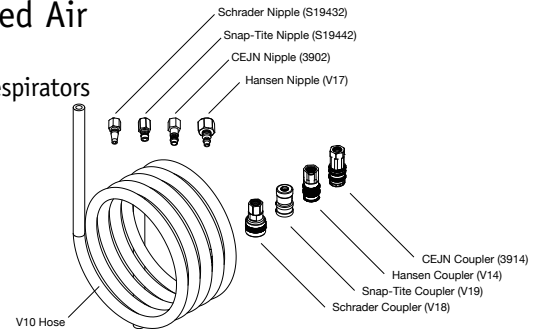

Starter Hoses (Includes nipple on one end and coupler on the other)

25-Foot Lengths

- 4696** V1025ST Industrial Interchange Hose Kit (Black)
- 1/4" Industrial Interchange quick-disconnect coupler
 - V13 hose-to-pipe adapter fitting (3/8" hose to 3/8" pipe)
 - For use with compressed air only. Not for use with Bullard Free-Air® pumps
 - For use with Bullard CC20, GR50, RT, FAMB, Spectrum® CF, GenVX™, and 88VX series respirators
 - V17 male nipple included

- 46913** V1025ST Schrader Hose Kit (Black)
- 1/4" Schrader quick-disconnect coupler
 - V13 hose-to-pipe adapter fitting (3/8" hose to 3/8" pipe)
 - For use with compressed air only. Not for use with Bullard Free-Air® pumps
 - For use with Bullard CC20, GR50, RT, FAMB, Spectrum®, GenVX™, and 88VX series respirators

- 46915** V1025ST Snap-Tite Hose Kit (Black)
- 46916** V1025ST Snap-Tite Hose Kit (Green)
- 46918** V1025ST Snap-Tite Hose Kit (Blue)
- 1/4" Snap-Tite quick-disconnect coupler
 - V13 hose-to-pipe adapter fitting (3/8" hose to 3/8" pipe)
 - For use with compressed air only. Not for use with Bullard Free-Air® pumps
 - For use with Bullard CC20, GR50, RT, FAMB, Spectrum®, GenVX™, and 88VX series respirators

50-Foot Lengths

- 469650** V1050ST Industrial Interchange Hose Kit (Black) - includes V17 (not pictured)
- 46917** V1050ST Snap-Tite Hose Kit (Green) (Not Pictured)
- 46919** V1050ST Snap-Tite Hose Kit (Blue) (Not Pictured)
- 1/4" quick-disconnect coupler
 - V13 hose-to-pipe adapter fitting (3/8" hose to 3/8" pipe)
 - For use with compressed air only. Not for use with Bullard Free-Air® pumps
 - For use with Bullard CC20, GR50, FAMB, Spectrum®, GenVX™, and 88VX series respirators

100-Foot Lengths

- 4696100** V10100ST Industrial Interchange Hose Kit (Black) - includes V17 (not pictured)
- 1/4" Industrial Interchange quick-disconnect coupler and male nipple
 - V13 hose-to-pipe adapter fitting (3/8" hose to 3/8" pipe)
 - For use with compressed air only. Not for use with Bullard Free-Air® pumps
 - For use with Bullard CC20, GR50, FAMB, Spectrum® CF, GenVX™, and 88VX series respirators

Breathing Air Supply Hose

Extension Hoses

25-Foot Lengths

- 5454 V1025 extension Hose Kit (Black)
- 54510 V1025 extension Hose Kit (Green)
- 54514 V1025 extension hose kit (Blue)
 - V11 hose-to-hose adapter fitting
 - V13 hose-to-pipe adapter fitting ($\frac{3}{8}$ " hose to $\frac{3}{8}$ " pipe)
 - For use with compressed air only. Not for use with Bullard Free-Air® pumps



50-Foot Lengths

- 5457 V1050 extension Hose Kit (Black)
- 54511 V1050 extension Hose Kit (Green)
- 54513 V1050 extension Hose Kit (Blue)
 - V11 hose-to-hose adapter fitting
 - V13 hose-to-pipe adapter fitting ($\frac{3}{8}$ " hose to $\frac{3}{8}$ " pipe)
 - For use with compressed air only. Not for use with Bullard Free-Air® pumps

100-Foot Lengths

- 5458 V10100 extension Hose Kit (Black)
- 54512 V10100 extension Hose Kit (Blue)
 - V11 hose-to-hose adapter fitting
 - V13 hose-to-pipe adapter fitting ($\frac{3}{8}$ " hose to $\frac{3}{8}$ " pipe)
 - For use with compressed air only. Not for use with Bullard Free-Air® pumps

V20 1/2" ID Hose for Free-Air® Pumps

- V2025SSTSHUTOFF V20 Industrial Interchange Hose (Black)
 - 25 feet of hose
 - $\frac{1}{2}$ " Industrial Interchange (Hansen compatible) shut-off coupler
 - For use with Bullard Free-Air® pumps

- V2050ST V20 Industrial Interchange Hose (Black)
 - 50 feet of hose
 - $\frac{1}{2}$ " Industrial Interchange (Hansen compatible) quick-disconnect coupler and nipple
 - For use with Bullard Free-Air® pumps



- V20100ST V20 Industrial Interchange Hose (Black)
 - 100 feet of hose
 - $\frac{1}{2}$ " Industrial Interchange (Hansen compatible) quick-disconnect coupler and nipple
 - For use with Bullard Free-Air® pumps

Hose Adapters

- V11 $\frac{3}{8}$ " Hose to $\frac{3}{8}$ " Hose Adapter, Brass



- V12 $\frac{3}{8}$ " Hose to $\frac{1}{4}$ " Pipe Adapter, Brass



- V13 $\frac{3}{8}$ " Hose to $\frac{3}{8}$ " Pipe Adapter, Brass



Supplied Air Fitting Guide

The couplings pictured below are the most popular styles used on airline respirators. A coupling, which is made up of a socket and a plug, is also called a "QD" or "fitting" and comes in various socket (female) and plug (male) sizes. Couplings can have male, female, or hose barb ends for different types of connections.

Industrial Interchange/Hansen-Compatible

Snap-Tite - Also known as Foster; "short and stubby"

Schrader - Looks like a bullet; turn the sleeve to release

CEJN - Similar to Hansen; two hands must be used to disconnect

Bayonet - Long and skinny with pins on the side; no ball bearings to trap grit. Favorite of abrasive blasters

Dynaswivel® - Swivels in two axes to keep hose from kinking



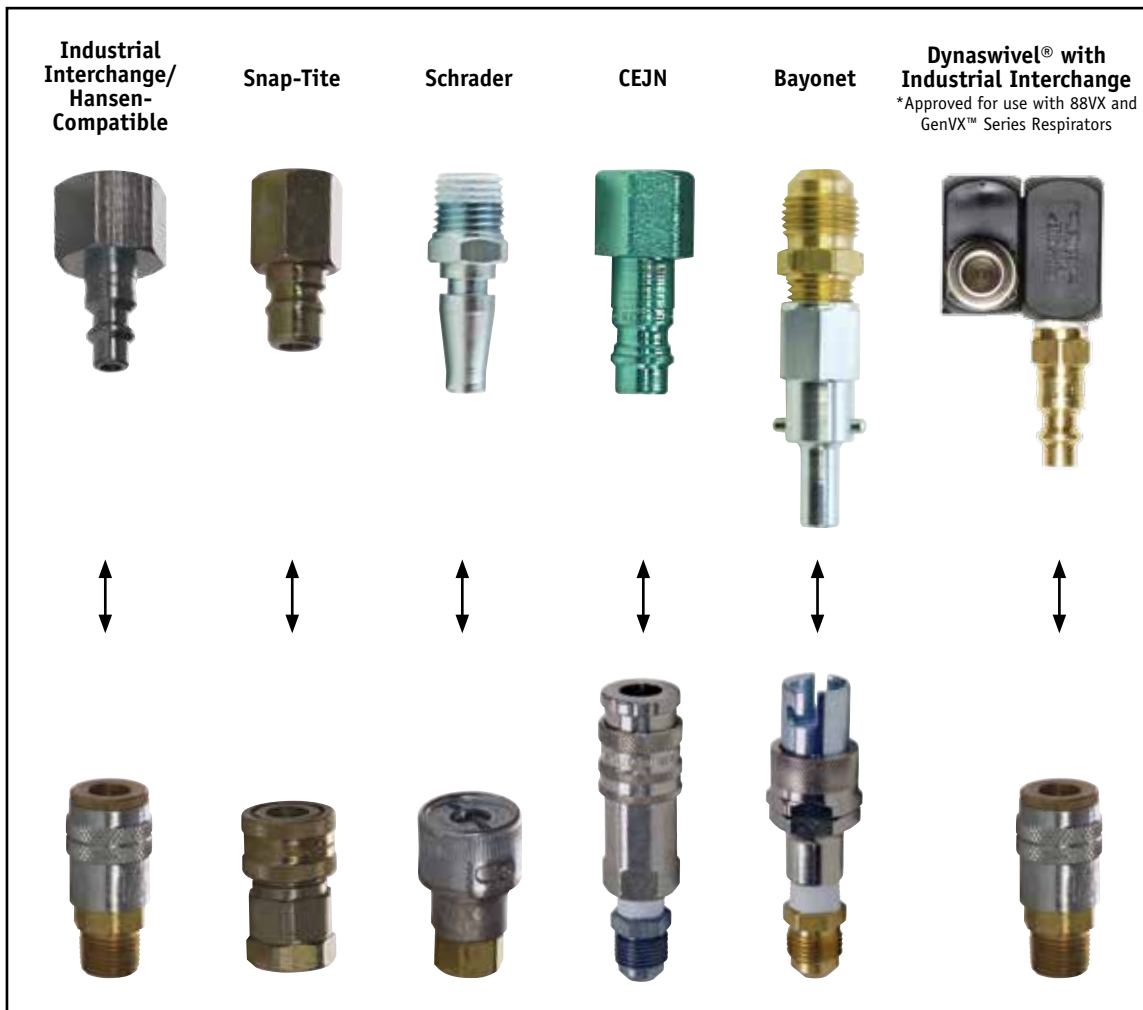



Quick-Disconnect Nipples



Quick-Disconnect Couplers

Breathing Air Supply Hose

Breathing Air Supply Hose - Quick-Disconnect Couplers

V14	<p>Industrial Interchange Female Coupler</p> <ul style="list-style-type: none">• 1/4" Industrial Interchange (Hansen compatible) quick-disconnect coupler• Includes shut-off with 1/4" female pipe thread (NPT)• V12 hose to pipe adapter required to connect to V10 extension hose	
V15	<p>Industrial Interchange Female Coupler</p> <ul style="list-style-type: none">• 1/4" Industrial Interchange (Hansen compatible) quick-disconnect coupler• Includes shut-off with 3/8" male pipe thread (NPT)	
V18	<p>Schrader Female Coupler</p> <ul style="list-style-type: none">• 1/4" Schrader quick-disconnect coupler• Includes shut-off with 1/4" female pipe thread (NPT)• V12 hose to pipe adapter required to connect to V10 extension hose	
V19 V19B	<p>Snap-Tite Female Coupler, Steel</p> <p>Snap-Tite Female Coupler, Brass</p> <ul style="list-style-type: none">• 1/4" Snap-Tite quick-disconnect coupler• Includes shut-off with 1/4" female pipe thread (NPT)• V12 hose to pipe adapter required to connect to V10 extension hose	
V27	<p>Industrial Interchange Coupler</p> <ul style="list-style-type: none">• 1/4" Industrial Interchange coupler assembly• Includes V12 hose to pipe adapter	
3914	<p>CEJN Coupler</p> <ul style="list-style-type: none">• 1/4" CEJN quick-disconnect coupler• Includes shut-off with 1/4" female pipe thread (NPT)• Includes special orifice adapter which connects respirator to the airline extension hose. Use only with orifice adapter• Includes V12 hose to pipe adapter	
3421	<p>Bayonet Coupler</p> <ul style="list-style-type: none">• 1/4" Bayonet quick-disconnect coupler• Includes shut-off with 1/4" female pipe thread (NPT)• Includes V12 hose to pipe adapter	

Breathing Air Supply Hose

Breathing Air Supply Hose - Quick-Disconnect Nipples

V17

Industrial Interchange Nipple

- 1/4" Industrial Interchange (Hansen compatible) steel male quick-disconnect nipple with 3/8" female pipe thread (NPT)
- Requires V13 hose adapter to connect to Bullard V10 air supply hose



S19432

Schrader Nipple

- 1/4" Schrader steel male quick-disconnect nipple with 1/4" female pipe thread (NPT)
- Requires V12 hose adapter to connect to Bullard V10 air supply hose



S19433

Schrader Nipple

- 1/4" Schrader steel male quick-disconnect nipple with 1/4" male pipe thread



S19442

Snap-Tite Steel Nipple

- 1/4" Snap-Tite steel male quick-disconnect nipple with 1/4" female pipe thread (NPT)
- Requires V12 hose adapter to connect to Bullard V10 air supply hose



S19443

Snap-Tite Brass Nipple

- 1/4" Snap-Tite brass male quick-disconnect nipple with 1/4" female pipe thread (NPT)
- Requires V12 hose adapter to connect to Bullard V10 air supply hose



3902

CEJN Nipple

- 1/4" CEJN steel male quick-disconnect nipple with 1/4" female pipe thread (NPT)
- Requires V12 hose adapter to connect to Bullard V10 air supply hose



3420

Bayonet Nipple

- 1/4" Bayonet steel male quick-disconnect nipple with 1/4" female pipe thread (NPT)
- Includes V12 hose to pipe adapter to connect to Bullard V10 air supply hose



3422

Bayonet Nipple (not pictured)

- 1/4" Bayonet steel male quick-disconnect nipple with 1/4" male pipe thread (NPT)
- Includes V12 hose to pipe adapter to connect to Bullard V10 air supply hose

Personal Climate Devices

Bullard climate control devices help increase worker comfort and productivity.

Bullard offers the largest number of personal climate devices for use with airline respirators. Each system enables a worker to adjust and control the temperature of air delivered to the respirator. On extremely hot summer days, air exiting a typical breathing air compressor can exceed 300°F (150°C). Air exiting a Free-Air® pump can exceed 200°F (100°C). Even with properly installed aftercoolers and in-line filters, the air entering a respirator could exceed ambient temperatures.

If workers breathe excessively warm air for prolonged periods of time, they may experience discomfort, fatigue, and possibly dehydration. During winter months, excessively cold air can have similar effects. Eventually, all of these conditions may reduce worker productivity. Bullard's personal climate devices help correct these uncomfortable working conditions for wearers of Bullard airline respirators.

Cool Tubes

The Bullard line of cool tubes are designed to cool incoming air from compressed breathing air sources by as much as 20°- 40°F (11°- 22°C) and feature adjustable airflow control valves that allow the user to adjust the incoming air temperature to a level best suited to individual comfort.

Hot/Cold Tubes

The Bullard Hot/Cold Tubes cool or warm incoming air from compressed breathing air sources. When used in the cool mode, the Hot/Cold Tube decreases the incoming air temperature by as much as 40°F (22°C). When warm air is desired, the incoming air temperature may be increased by up to 30°F (17°C).

DC50 Series Dual-Cool

The Dual-Cool Series provides superior cooling to Bullard respirators, while also sending cool air to the vest for upper torso cooling. The Dual-Cool will cool incoming air from compressed breathing sources by as much as 30°F (17°C). Separate control knobs allow the worker to adjust the temperature of air to each zone.

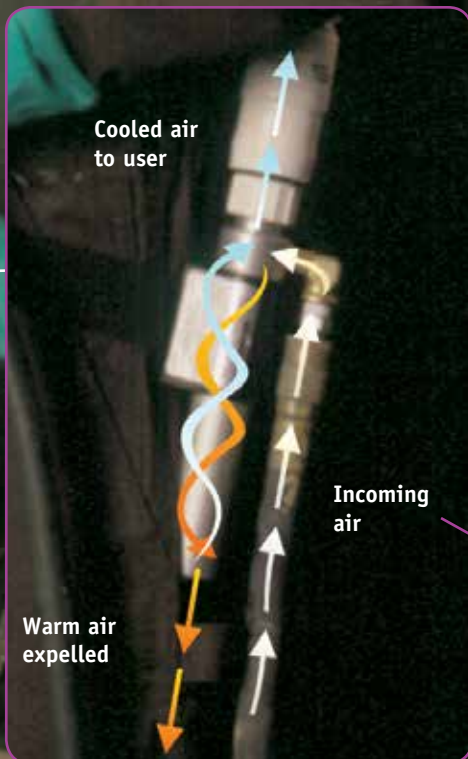

Personal Climate Devices

		Climate Control Devices					
		CT	AC1000	HCT	HC2400	Frigitron 2000	DC50 Dual-Cool
Respirator	GenVX™	X	X	X	X	X	X
	88VX	X	X	X	X	X	X
	20LF		X		X	X	X
	CC20		X		X	X	X
	RT		X		X	X	X
	GR50		X		X	X	X
	Spectrum®						
	FAMB						
Fitting Type	Hansen/Industrial Interchange	X	X	X	X	X	X
	Schrader	X	X	X	X		X
	Snap-Tite	X	X	X	X		X
	CEJN	X	X	X	X		X
	Dynaswivel®	X		X			
Air Source	Breathing Air Compressor	X	X	X	X	X	X
	Free-Air® Pump ADP20 & EDP30 Only					X	

Go to www.BuildYourBullard.com to configure entire system

Cubic Feet per Minute (cfm) Requirements					
Respirator Type	Flow Control Type	Minimum cfm	Respirator Type	Flow Control Type	Minimum cfm
FAMB	All	4	GR50	F30 Series	6
Spectrum®	All	4	GR50	F40 Series	6
20LF	F30 Series	6	GR50	AC1000 Series	15
20LF	F40 Series	6	GR50	HC2400 Series	15
20LF	AC1000 Series	15	GR50	DC50 Series	20
20LF	HC2400 Series	15	GR50	Frigitron 2000	15
20LF	DC50 Series	20	88VX	F30 Series	6
20LF	Frigitron 2000	15	88VX	F40 Series	6
CC20	F30 Series	6	88VX	AC1000 Series	15
CC20	F40 Series	6	88VX	HC2400 Series	15
CC20	AC1000 Series	15	88VX	CT Series	15
CC20	HC2400 Series	15	88VX	HCT Series	15
CC20	DC50 Series	20	88VX	DC50 Series	20
CC20	Frigitron 2000	15	88VX	Frigitron 2000	15
RT	F30 Series	6	GenVX™	F30 Series	6
RT	F40 Series	6	GenVX™	F40 Series	6
RT	AC1000 Series	15	GenVX™	AC1000 Series	15
RT	HC2400 Series	15	GenVX™	HC2400 Series	15
RT	DC50 Series	20	GenVX™	CT Series	15
RT	Frigitron 2000	15	GenVX™	HCT Series	15
			GenVX™	DC50 Series	20
			GenVX™	Frigitron 2000	15

Personal Climate Devices

Cool Tubes

- AC1000 Series**
- For use with Compressed Air
 - Metal Construction
 - Includes 1/4" male nipple and leather heat shield
 - For use with 88VX, GenVX™, CC20, RT, and GR50 Series Bullard Respirators

- AC100030** Hansen/Industrial Interchange
AC100031 Schrader
AC100032 Snap-Tite
AC100033 Snap-Tite Brass
AC100037 CEJN
AC100038 Bayonet (88VX and GenVX™ only)



- CT Series**
- For use with Compressed Air
 - Engineered Polymer Construction
 - Exhaust Filter protects against paint overspray
 - Directs hot air away from the body
 - For use with 88VX and GenVX™ Series Bullard Respirators
 - Includes 1/4" male nipple, nylon belt, and leather heat shield

- CT30** Hansen/Industrial Interchange
CT30B Hansen/Industrial Interchange - Brass
CT30S Hansen/Industrial Interchange - Stainless
CT30SW Hansen/Industrial Interchange - Dynaswivel®
CT30BSW Hansen/Industrial Interchange - Dynaswivel® Brass
CT30SSW Hansen/Industrial Interchange - Dynaswivel® Stainless
CT31 Schrader
CT32 Snap-Tite
CT33 Snap-Tite Brass
CT37 CEJN
CT38 Bayonet



- Frigitron 2000 Series**
- For use with Free-Air® Pumps
 - For use with 88VX, GenVX™, CC20, RT, and GR50 Series Bullard Respirators
 - Includes 1/2" male nipple, nylon belt, and leather heat shield

- FRIGITRON2000** Hansen/Industrial Interchange
FRIGITRON2000B Hansen/Industrial Interchange - Brass



Replacement Parts

- V1000** 1/4" Hansen/Industrial Interchange Nipple for AC1000 and CT Series



V1000

- 30SW** Dynaswivel® with 1/4" Hansen/Industrial Interchange Nipple for CT30SW and HCT30SW
30BSW Dynaswivel® Brass with 1/4" Hansen/Industrial Interchange Nipple for CT30SW and HCT30SW
30SSW Dynaswivel® Stainless with 1/4" Hansen/Industrial Interchange Nipple for CT30SW and HCT30SW

- 272556** 1/2" Hansen/Industrial Interchange Nipple and adapter for Frigitron2000



HS

- HS** Leather Heat Shield

- CTF** Cool Tube Filter - Package of 10



4612

- 4612** Nylon Belt



- 36501** Vinyl Decon Belt

36501

Personal Climate Devices

Hot/Cold Tubes

- HC2400 Series**
- For use with Compressed Air
 - Metal Construction
 - For use with 88VX, GenVX™, CC20, RT, and GR50 Series Bullard Respirators
 - Includes 1/4" male nipple, nylon belt, and leather heat shield

- HC240030** Hansen/Industrial Interchange
- HC240031** Schrader
- HC240032** Snap-Tite
- HC240033** Snap-Tite Brass
- HC240037** CEJN
- HC240038** Bayonet (88VX and GenVX™ only)



- HCT Series**
- For use with Compressed Air
 - Engineered Polymer Construction
 - Exhaust Filter protects against paint overspray
 - Directs hot air away from the body
 - For use with 88VX and GenVX™ Series Bullard Respirators
 - Includes 1/4" male nipple, nylon belt, and leather heat shield

- HCT30** Hansen/Industrial Interchange
- HCT30B** Hansen/Industrial Interchange Brass
- HCT30S** Hansen/Industrial Interchange - Stainless
- HCT30SW** Hansen/Industrial Interchange - Dynaswivel®
- HCT30BSW** Hansen/Industrial Interchange - Dynaswivel® Brass
- HCT30SSW** Hansen/Industrial Interchange - Dynaswivel® Stainless
- HCT31** Schrader
- HCT32** Snap-Tite
- HCT33** Snap-Tite Brass
- HCT37** CEJN
- HCT38** Bayonet



Replacement Parts

- V1000** 1/4" Hansen/Industrial Interchange Nipple for AC1000 and CT Series
- 30SW** Dynaswivel® with 1/4" Hansen/Industrial Interchange Nipple for CT30SW and HCT30SW
- 30BSW** Dynaswivel® Brass with 1/4" Hansen/Industrial Interchange Nipple for CT30SW and HCT30SW
- 30SSW** Dynaswivel® Stainless with 1/4" Hansen/Industrial Interchange Nipple for CT30SW and HCT30SW



- HS** Leather Heat Shield



- 4612** Nylon Belt



- 36501** Vinyl Decon Belt



Personal Climate Devices

Dual Cool Tubes for use with Vests (purchased separately) and Respirator

- DC5040 Series**
- For use with Compressed Air
 - Metal Construction
 - For use with 88VX, GenVX™, CC20, RT, and GR50 Series Bullard Respirators
 - Includes 1/4" male nipple, nylon belt, and leather heat shield

- DC5040** Hansen/Industrial Interchange
DC5041 Schrader
DC5042 Snap-Tite
DC5043 Snap-Tite Brass
DC5047 CEJN
DC5048 Bayonet (88VX and GenVX™ only)

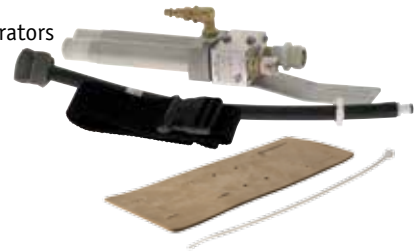

Replacement Parts

- V1000** 1/4" Hansen/Industrial Interchange Nipple for HC24000 and HCT Series



- DCHS** Leather Heat Shield



- CH60** Connector Hose



- S18052** Clamp



Air Fed Cool Vest

- DC 70 Series**
- For use with DC5040, AC1000DC, or CT30DC Personal Cooling Devices
 - May be worn without a respirator when used with AC1000DC or CT30DC Personal Cooling Device
 - For use with 88VX, GenVX™, CC20, RT, and GR50 Series Bullard Respirators
 - Nylon Outer Shell
 - Breathable Cotton Inner Shell

- DC70ML** Medium/Large, 49" Chest
DC70XLXXL Extra Large / 2XL, 53.5" Chest
DC705XL 5XL, 66" Chest



Cool Tubes for use with Air Fed Vest without respirator

- AC1000DC** • Includes 1/4" male nipple, nylon belt, and leather heat shield, and CH1000



- CT30DC** • Includes 1/4" male nipple, nylon belt, and leather heat shield, and CH1000



Personal Climate Devices

Air Fed Cool Vest

Replacement Parts

CH1000 Connector hose with clamp



V1000 1/4" Hansen/Industrial Interchange Nipple for HC24000 and HCT Series



HS Leather Heat Shield



4612 Nylon Belt



36501 Vinyl Decon Belt



Air Quality and Filtration

41 Series Airline Filters

41 Series Airline Filters help deliver cleaner air for up to six workers.

Versatile Application

OSHA requires that employers provide their workers with Grade D breathing air. Bullard Airline Filters can be used in conjunction with other compressor safeguards, such as carbon monoxide monitoring, to help supply Grade D breathing air to supplied air respirators. They may also be used to supply drier, cleaner air to tools and pneumatic systems to reduce down-time and repair costs.

Heavy Duty

The 41 Series Airline Filters are constructed of heavy-gauge steel to withstand rugged industrial environments.

High Capacity

41 Series Airline Filters contain large disposable filter cartridges, allowing for longer periods of filtration.

Light Weight for Easy Portability

Each model weighs approximately 23 pounds (10.5 kg).

Efficient

The 41 Series Filter cartridges are specifically designed to effectively trap and remove oil particulates, odor, and organic vapors using a multi-layer filtering system. Compressor-supplied air enters the filter and travels through six layers of filter material before exiting through the outlet port. Carded cotton, felt material, activated charcoal, and activated alumina work in sequence to supply cleaner air to workers or equipment.

Replaceable filter cartridge (7-stage operation)

Cartridges effectively trap and remove impurities with little pressure loss. The supplied air enters the compressor at inlet connector (A), travels through six layers of filter material, and exits outlet connector (B). Filter materials work in sequence to trap and hold water, oil, particulates, odors, and organic vapors, so that cleaner air is delivered to workers or equipment.

1. Water is removed by condensation against the cylinder wall
2. Carded cotton removes particulates
3. Activated alumina adsorbs oil and moisture
4. Activated charcoal removes odors and moisture
5. Felt material removes particulates
6. Carded cotton removes particulates
7. Respiratory felt at final stage acts as a final filter before air is transferred to worker or air driven tools

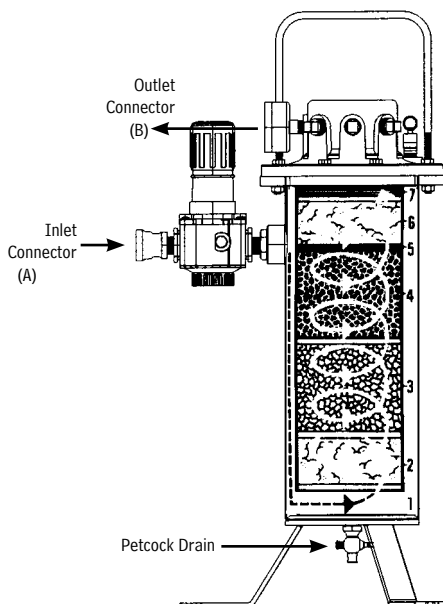

41 Series Airline Filters

Specifications						
Airline Filter	Model 41A	Model 41P2	Model 41PWM	Model 41P6	Model 41P6WM	Model 41P2E
Max. Air Flow Rate	100 cfm* (2830 lpm)	75 cfm (2120 lpm)	75 cfm (2120 lpm)	75 cfm (2120 lpm)	75 cfm (2120 lpm)	75 cfm (2120 lpm)
Inlet Connection	1" NPT (Fem.)	1" NPT (Fem.)	1" NPT (Fem.)	1" NPT (Fem.)	1" NPT (Fem.)	3/4" (19 mm) NPT (Fem.)
Outlet Connection	1" NPT (Fem.)	2 outlets 3/8" NPT (Fem.)	2 outlets 3/8" NPT (Fem.)	6 outlets 3/8" NPT (Fem.)	6 outlets 3/8" NPT (Fem.)	2 outlets 1/4" (6 mm) BPT (Fem.)
Relief Valve	-	125 psig (8.6 bar)	125 psig (8.6 bar)	125 psig (8.6 bar)	125 psig (8.6 bar)	125 psig (8.6 bar)
Tank Diameter	5 1/2" (14 cm)	5 1/2" (14 cm)	5 1/2" (14 cm)	5 1/2" (14 cm)	5 1/2" (14 cm)	5 1/2" (14 cm)
Height	19" (48 cm)	23 1/2" (60 cm)	23" (58 cm)	25 1/4" (64 cm)	22" (56 cm)	23 1/2" (60 cm)
Weight	19 lb. (8.6 kg)	22 lb. (10 kg)	27 lb. (12.2 kg)	24 lb. (10.9 kg)	28 lb. (12.7 kg)	22 lb. (10 kg)

*At maximum recommended pressure of 100 psig (6.9 bar)

41 Series Portable Filtration and CO Monitoring

One-or-Two Worker Systems

All assemblies include Heavy Duty 41 Series Filter with 7-stage filtration, CO monitor with auto calibration, audible and visual alarms for high CO and low battery, and 6-foot 110 VAC power cord.

10 PPM PART NUMBER	5 PPM PART NUMBER	
COHP41P2	C05HP41P2	75 cfm, Two-Outlet Unit
COHP41P2CABCK	C05HP41P2CABCK	75 cfm, Two-Outlet Unit • Calibration Kit Included
COHP41P2WMCABCK	C05HP41P2WMCABCK	75, cfm Two-Outlet Unit • Calibration Kit Included • Wall Mount Bracket Included



COHP41P2

Bundles

COHP41P2CC20	Includes CC20 Respirator (CC20TIC30RT)
COHP41P288VX	Includes 88VX Respirator (88VX3230)

One-to Six-Worker Systems

All assemblies include Heavy Duty 41 Series Filter with 7-stage filtration, CO monitor with auto calibration, audible and visual alarms for high CO and low battery, and 6-foot 110 VAC power cord.

10 PPM PART NUMBER	5 PPM PART NUMBER	
COHP41P6	C05HP41P6	75 cfm, Six-Outlet Unit

Breathing Air Filtration

41 Series Filter Assemblies

- 41A** Single Outlet
- 1" NPT inlet, 1" NPT outlet
 - Includes 41AF filter cartridge
 - Does not include regulator, pressure gauge, or relief valve
 - Handle (41HK) must be ordered separately
 - Shipping weight: 22 lbs. Cube: 2.9



- 41P2** 2-Outlet
- 1" NPT inlet, 1/4" and 3/8" NPT (female) outlets
 - Includes 41AF filter cartridge
 - Regulator adjustable between 0-100 psig
 - Relief valve set at 125 psig
 - Pressure gauge
 - Handle (41HK) must be ordered separately
 - Shipping weight: 27 lbs. Cube: 2.9



- 41P2WM** 2-Outlet Wall Mount
- Same as Model 41P2 with:
- Galvanized steel wall mount bracket (no legs)
 - Shipping weight: 31 lbs. Cube: 2.9



- 41P6** 6-Outlet
- 1" NPT inlet, 3/8" NPT (female) outlets
 - Includes 41AF filter cartridge
 - Regulator adjustable between 0-100 psig
 - Relief valve set at 125 psig
 - Pressure gauge
 - Shipping weight: 27 lbs. Cube: 2
 - Handle (41HK) must be ordered separately



- 41P6WM** 6-Outlet, Wall Mount
- Same as Model 41P6 above with:
- Galvanized steel wall mount bracket (no legs)
 - Shipping weight: 31 lbs. Cube: 2.9













- 41AF** Filter Cartridge
- Filter cartridge for 41A, 41P2, 41P6 and 41P6WM
 - Shipping weight: 6 lbs. Cube: .6



Breathing Air Filtration

41 Series Filter Replacement Parts

41ATOPYLW	41A Manifold Plate for 41A Filter <ul style="list-style-type: none">• Regulator relief valve, and pressure gauge not included	
41P2M	41P2 Manifold Assembly for 41P2 Filter <ul style="list-style-type: none">• Steel manifold plate• Regulator adjustable between 0-100 psig• Relief valve set at 125 psig• Pressure gauge• Shipping weight: 7.0 lbs.	
41P6UPK	41P6 Manifold Assembly for 41P6 Filter <ul style="list-style-type: none">• Steel manifold plate• Regulator adjustable between 0-100 psig• Relief valve set at 125 psig• Pressure gauge• Shipping weight: 10.0 lbs.	
41RG	Regulator Gauge <ul style="list-style-type: none">• For 41P2 and 41P6• 0-160 psi	
41PRV	Pressure Relief Valve <ul style="list-style-type: none">• For 41P2 and 41P6• 125 psig activation	
41P2R	41P2 Regulator and Gauge Assembly <ul style="list-style-type: none">• For use with flat top design only	
41P6R	41P6 Regulator, no gauge or connection fittings	
V15	Industrial Interchange Female Coupler <ul style="list-style-type: none">• 3/4" Industrial Interchange (Hansen compatible) quick-disconnect coupler• Includes shut-off with 3/8" male pipe thread (NPT)	
41KB2	Replacement Knob for 41P2	
41HK	Handle Kit <ul style="list-style-type: none">• For use with all 41 Series Airline Filters	
41DRAIN	Petcock	
41ACABKIT	Connection kit from 41A to a Clean Air Box (CAB) (not pictured) <ul style="list-style-type: none">• Includes two reducers• Includes Hansen Compatible Coupler	



Clean Air Box (CAB) Series Breathing Air Filtration

Clean Air Boxes (CAB)

High Performance Air Filtering and Monitoring

Clean Air Boxes can help employers comply with Grade D breathing standards by providing high-performance particulate filtration and continuous CO monitoring. Available as either enclosed portable case, or fixed wall mount, these units feature high-performance three-stage filtration, auto-drains, CO monitoring, filter change indicators, and the capacity to support up to eight workers.

Remote Air Manifold (RAM)

Air Distribution and Regulation

Remote Air Manifolds are effective for air distribution and regulation to multiple workers from a common air source. Standard features include multiple respirator couplings, single or multiple pressure regulators, and a rugged Pelican™ protective case.

Carbon Monoxide Monitors

Continuous Monitoring for Carbon Monoxide

This compact, durable unit connects easily to any compressed breathing air source (connection kit included). The monitor is factory set to sound a 93dB alarm when CO level exceeds 10ppm, the OSHA limit. Monitors are also available with a CO alarm set point of 5ppm to meet CSA and certain international requirements. External operation lights show green for normal and red for alarm for easy visual monitoring. An external alarm connection allows for the use of remote alarm devices. Monitors operate on 9-volt battery or 110-volt AC power. Backup battery power supply capability is standard on all units.

CAB Series Sizing Chart

*This chart is intended solely as a guide. The actual number of respirators that may be connected to these products is dependent on the inlet pressure to the panel and the airflow and pressure requirements of the respirator.

Number of Workers	Mask Respirators	Hood Respirators	Hood Respirators with Cool Tubes*
1	CAB15	CAB15	CAB15
2	CAB15 or COHP41P2	CAB30 or COHP41P2	CAB30 or COHP41P2
3	CAB15 or COHP41P6	CAB30 or COHP41P6	CAB50 or COHP41P6
4	CAB30 or COHP41P6	CAB50 or COHP41P6	CAB50 or COHP41P6
5	CAB30 or COHP41P6	CAB50 or COHP41P6	CAB100 or COHP41P6
6	CAB30 or COHP41P6	CAB100 or COHP41P6	CAB100 or COHP41P6
7	CAB50 or COHP41P6	CAB100 or COHP41P6	CAB100
8	CAB50 or COHP41P6	CAB100 or COHP41P6	CAB100

* Single Cool Tubes

RAM Series Sizing Chart

Number of Workers	Mask Respirators	Hood Respirators	Hood Respirators with Cool Tubes*
1	RAM1	RAM1	RAM1
2	RAM2	RAM2	RAM2
3	RAM4	RAM4	RAM4
4	RAM4	RAM4	RAM4
5	RAM8	RAM8	RAM8
6	RAM8	RAM8	RAM8
7	RAM8	RAM8	RAM8
8	RAM8	RAM8	RAM8

* Single Cool Tubes

CAB Breathing Air Filtration

CO Monitoring Systems

10 PPM PART NUMBER	5 PPM PART NUMBER	
COHP	C05HP	CO Monitor System for High Pressure
COHP41P2	C05HP41P2	75 cfm, two-outlet unit
COHP41P6	C05HP41P6	75 cfm, six-outlet unit
COHP41P2CABCK	C05HP41P2CABCK	75 cfm, two-outlet unit • Calibration Kit Included
COHP41P2WMCABCK	C05HP41P2WMCABCK	75 cfm, two-outlet unit • Calibration Kit Included • Wall Mount Bracket Included



COHP41P2

CO Monitor Series Accessories

COHPKIT	Connection Kit from COHP to Filter • Includes coupler, connection hose, and brass bushing
COHPAK	COHP Connector Hose • Only connector hose is included (Tygon® Tubing)
COHPCC	Replacement Colder Coupler • Female fitting on end of connector hose



CAB Series Portable Filtration and CO Monitoring

One-Worker System with Tychem® Respirator

All assemblies include a Clean Air Box, 3-stage filtration, visual filter change indicators, CO monitor with auto-calibration, and audible and visual alarms for high CO and low battery. Respirator includes DuPont™ Tychem® hood, AC1000 cool tube, breathing tube, and breathing hose assembly. (25')

10 PPM PART NUMBER	5 PPM PART NUMBER	
CAB15HASYS*	CAB15HASYS5*	15 cfm Clean Air Box System with 20TIC DuPont™ Tychem® Hood Respirator



CAB15HASYS

One-Worker System with Spectrum® Respirator

All assemblies include a Clean Air Box, 3-stage filtration, visual filter change indicators, CO monitor with auto-calibration, and audible and visual alarms for high CO and low battery. Respirator includes Spectrum® mask, breathing tube, and breathing hose assembly. (100')

10 PPM PART NUMBER	5 PPM PART NUMBER	
SPECLCABSYS	SPECLCABSYS5	15 cfm Clean Air Box System with Spectrum® Mask Respirator



SPECLCABSYS

One Worker System with Blasting Respirator

All assemblies include a Clean Air Box, 3-stage filtration, visual filter change indicators, CO monitor with auto-calibration, audible and visual alarms for high CO and low battery. Respirator includes 88VX3230 hood, AC1000 cool tube, breathing tube and breathing hose assembly. (25')

10 PPM PART NUMBER	5 PPM PART NUMBER	
CAB15HA88VXSYS*	CAB15HA88VXSYS5*	15 cfm Clean Air Box System with 88VX3230 Blasting Respirator



CAB15HA88VXSYS

* Requires upgrade kit for use with Remote Alarm

Clean Air Box (CAB) Filtration

CAB Series Portable Filtration and CO Monitoring

All assemblies include 3-stage filtration, visual filter change indicators, automatic filter drains, CO monitor with auto calibration, audible and visual alarms for high CO and low battery, 6-foot 110V AC power cord and remote alarm connection (except for CAB15). Remote Alarm and calibration kits are sold separately.

Pelican™ Case Unit Single Regulator Manifolds

10 PPM PART NUMBER	5 PPM PART NUMBER	
CAB15XX	CAB15XX5	1-2 worker, 15 cfm (V25 splitter required for 2 workers)
CAB30XX	CAB30XX5	1-2 worker, 30 cfm

Refer to XX key below.

CAB50XX	CAB50XX5	1-4 worker, 50 cfm
CAB100XX	CAB100XX5	1-8 worker, 100 cfm

CAB15RAUPGRADE CAB15 upgrade kit for use with Remote Alarm

Refer to XX key below.



CAB15HA



CAB30HA



CAB50HA



CAB100HA

Independent Regulators

10 PPM PART NUMBER	5 PPM PART NUMBER	
CAB30IRXX	CAB30IRXX5	1-2 worker, 30 cfm
CAB50IRXX	CAB50IRXX5	1-4 worker, 50 cfm
CAB100IRXX	CAB100IRXX5	1-8 worker, 100 cfm



CAB30IRHA



CAB50IRHA



CAB100IRHA

XX Key for Outlet Couplers

When placing an order indicate your choice of outlet coupler for each CAB.

- HA - Hansen/Industrial Interchange Coupler
- SC - Schrader Coupler
- SN - Snap-Tite Coupler
- CE - CEJN Coupler
- SS - Stainless Hansen/Industrial Interchange Coupler



Clean Air Box Breathing Air Filtration

CAB Series Portable Filtration and CO Monitoring

All assemblies include 3-stage filtration, visual filter change indicators, automatic filter drains, CO monitor with auto calibration, audible and visual alarms for high CO and low battery, 6 foot 110V AC power cord, and remote alarm connection (except for CAB15). Remote Alarm and calibration kits are sold separately.

Panel Mount Units

Single Regulator Manifolds

10 PPM PART NUMBER	5 PPM PART NUMBER
-----------------------	----------------------

CAB15PMXX	CAB15PMXX5	1-2 worker, 15 cfm (V25 splitter required for 2 workers)
CAB30PMXX	CAB30PMXX5	1-2 worker, 30 cfm



CAB15PM



CAB30PM

Refer to XX key below.

CAB50PMXX	CAB50PMXX5	1-4 worker, 50 cfm
CAB100PMXX	CAB100PMXX5	1-8 worker, 100 cfm



CAB50PM



CAB100PM

CAB15RAUPGRADE CAB15 upgrade kit for use with Remote Alarm

Refer to XX key below.

Independent Regulators

10 PPM PART NUMBER	5 PPM PART NUMBER
-----------------------	----------------------

CAB30PMIRXX	CAB30PMIRXX5	1-2 worker, 30 cfm
CAB50PMIRXX	CAB50PMIRXX5	1-4 worker, 50 cfm
CAB100PMIRXX	CAB100PMIRXX5	1-8 worker, 100 cfm



CAB30PMIR



CAB50PMIR

Refer to XX key below.



CAB100PMIR

XX Key for Outlet Couplers

When placing an order indicate your choice of outlet coupler for each CAB.

- HA - Hansen/Industrial Interchange Coupler
- SC - Schrader Coupler
- SN - Snap-Tite Coupler
- CE - CEJN Coupler
- SS - Stainless Hansen/Industrial Interchange Coupler

Remote Air Manifolds (RAM)

RAM1WMHA One Outlet Remote Air Manifold with Hansen Outlet Coupling



RAM1WMHA

All assemblies include Pelican™ case, male inlet fitting, regulator(s), pressure gauge(s), and female quick-disconnect outlet coupling.
Single Regulator Manifolds

RAM1XX 1 worker



RAM1

RAM2XX 1-2 worker



RAM2

RAM4XX 1-4 worker



RAM4

RAM8XX 1-8 worker



RAM8

Refer to XX key below.

Independent Regulators

RAM2IRXX 1-2 worker



RAM2IR

RAM4IRXX 1-4 worker



RAM4IR

RAM8IRXX 1-8 worker



RAM8IR

Refer to XX key below.

XX Key for Outlet Couplers

When placing an order indicate your choice of outlet coupler for each CAB.

- HA - Hansen/Industrial Interchange Coupler
- SC - Schrader Coupler
- SN - Snap-Tite Coupler
- CE - CEJN Coupler
- SS - Stainless Hansen/Industrial Interchange Coupler



Clean Air Box (CAB) Filtration

CAB Replacement Parts and Accessories

Calibration Kits and Gas

Full Kits

- CABCK** Calibration Kit (includes Zero Air 34L Cylinders, 10 ppm CO, Regulator, Tubing, and Connector)
Approximately 25 calibrations
- CABCK17L** Same as above, with 17L Cylinders - no carrying case
Approximately 12 calibrations
- CABCK103L** Same as above, with 103L Cylinders
Approximately 77 calibrations



CABCK

Replacement Cylinders

- CABCGO** Zero Air, 34L Cylinder (Regulator not included, order CABCALREG if needed)
- CABCGO17L** Zero Air, 17L Cylinder (Regulator not included, order CABCALREG if needed)
- CABCGO103L** Zero Air, 103L Cylinder (Regulator not included, order CABCALREG103 if needed)
- CABCG10** 10 PPM CO, 34L Cylinder (Regulator not included, order CABCALREG if needed)
- CABCG1017L** 10 PPM CO, 17L Cylinder (Regulator not included, order CABCALREG if needed)
- CABCG10103L** 10 PPM CO, 103L Cylinder (Regulator not included, order CABCALREG103 if needed)

Other Replacement Items

- CABCALREG** Regulator, tubing and connector fitting for CABCK calibration kit
- CABCALREG103** Regulator, tubing and connector fitting for CABCK103L calibration kit
- CABREGTB** Tygon® tubing for regulator

- RA** Remote Alarm
- COM5** Replacement CO Monitor, 5ppm Alarm Set Point
- COM10** Replacement CO Monitor, 10ppm Alarm Set Point
- CABRS** Replacement Sensor for CO Monitor
- CABRS2** Replacement Sensor
- CABKS** Kickstand for 15-100 cfm CAB Models
- RACABLE** Replacement Cable 50'
- COHPKIT** Tygon® Tubing and Connector Kit
- COHPAK** COHPconnector hose (Tygon® Tubing)



Kickstand



RA

Replacement Filters and Change Indicators for 15 & 30 cfm Models

- CAB30FA** Filter Stage 1 - 15 or 30 cfm (entire filter housing included)
- CAB30FB** Filter Stage 2 - 15 or 30 cfm (entire filter housing included)
- CAB30FC** Filter Stage 3 - 15 or 30 cfm (entire filter housing included)



CAB30FA

CAB30FB

CAB30FC

Replacement Filter Elements

- CAB30FK** Filter Element Kit, Includes CAB30FEA, CAB30FEB and CAB30FEC
- CAB30FEA** Filter Element A - Particulate (outer housing not included)
- CAB30FEB** Filter Element B - Coalescing (outer housing not included)
- CAB30FEC** Filter Element C - Activated Charcoal (outer housing not included)

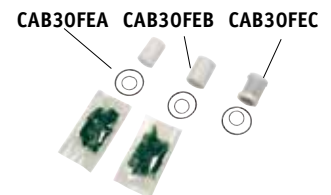

CAB30FK

- CAB30ADA** Filter Auto Drain Bowl - 15 or 30 cfm



CAB30ADA

CAB Breathing Air Filtration

CAB and RAM Series Accessories

Replacement Filters, Elements and Change Indicators For 50 cfm Models

CAB50FA	Filter Stage 1 - 50 cfm
CAB50FB	Filter Stage 2 - 50 cfm
CAB50FC	Filter Stage 3 - 50 cfm
CAB50FK	Filter Element Kit <ul style="list-style-type: none"> • Includes CAB50FEA, CAB50FEB, and CAB50FEC
CAB50FEA	Filter Element A - Particulate
CAB50FEB	Filter Element B - Coalescing
CAB50FEC	Filter Element C - Activated Charcoal



For 100 cfm Models

CAB100FA	Filter Stage 1 - 100 cfm
CAB100FB	Filter Stage 2 - 100 cfm
CAB100FC	Filter Stage 3 - 100 cfm
CAB100FK	Filter Element Kit <ul style="list-style-type: none"> • Includes CAB100FEA, CAB100FEB, and CAB100FEC
CAB100FEA	Filter Element A - Particulate
CAB100FEB	Filter Element B - Coalescing
CAB100FEC	Filter Element C - Activated Charcoal
CAB100MB	Mounting Block



Filter Change Indicator

CAB15FCI	Filter Change Indicator 15 cfm
CAB30FCI	Filter Change Indicator 30 cfm
CAB50FCIA	Filter Change Indicator 50 cfm, Stage 1
CAB50FCIB	Filter Change Indicator 50 cfm, Stage 2
CAB100FCIA	Filter Change Indicator 100 cfm, Stage 1
CAB100FCIC	Filter Change Indicator 100 cfm, Stages 2 and 3



Replacement Regulators and Parts

CABREG1	Replacement Regulator 15 and 30
CABREG2	Replacement Regulator 50
CABREG3	Replacement Regulator 100
CABREG4	Replacement Independent Regulator
CABQDHA	Quick-Disconnect Outlet Fitting Hansen (v14)
CABQDSN	Quick-Disconnect Outlet Fitting Snap Tite
CABQDSC	Quick-Disconnect Outlet Fitting Schrader
CABQDCE	Quick-Disconnect Outlet Fitting CEJN
CABQDSS	Quick-Disconnect Outlet Fitting Hansen Stainless Steel
CABQDNV	Quick-Disconnect Outlet Fitting Nova
CABQDCAP	Quick-Disconnect Dust Cap
41PRV	Pressure Relief Valve, 125psi - All CAB and RAM Units
S196810	Replacement Gauge (CAB30)
CABFR	CAB Fuse Replacement Kit
S17456	Inlet fitting
V25HA	CAB Hansen, 2-person, Outlet Coupling Splitter
41ACAB	CAB Hansen, 2-person, Outlet Coupling Splitter
41ACABKIT	Connection Kit for 41 Filter to CAB



CABREG1



CABQDCAP

Power Cords

CABCORDJA	6-Foot Power Cord for Japan
CABCORDUK	6-Foot Power Cord for United Kingdom
CABCORDAU	6-Foot Power Cord for Australia
CABCORDEU	6-Foot Power Cord for Europe
CABPC	U.S. Powercord



CABCORDEU



Free-Air® Pumps

Reliable, Economical Air Sources for Airline Respirators.

Easy to operate and maintain, Bullard Free-Air® pumps offer a low-cost way to supply clean, breathable air to workers in contaminated environments. They are an economical air source when compressed air is not available and an inexpensive way to add breathing capacity when a compressed air source is at its maximum utilization.

Economical

Bullard Free-Air® pumps are efficient and economical. They are portable and can be moved quickly and easily from jobsite to jobsite. Plus, they require no expensive plumbing or installation. Bullard Free-Air® pumps are oil-less, so they do not produce carbon monoxide, oil vapor, or oil mist. Since CO monitors, temperature alarms, airline filters, and complicated calibration equipment aren't necessary, Free-Air® pumps are frequently a more cost-effective alternative to compressed air.

Easy-To-Use

Bullard Free-Air® pumps are reliable and easy to use. They are available in both electric and air driven models. Electric models have low power requirements; simply plug in, set the proper air pressure, and go to work. The air-driven model is ideal for both general purpose and hazardous duty use. Used with optional extension hose kits, the breathable air inlet can be located up to 300 feet away from the pump.

Pump and Number of Workers

Model	cfm	Number of Workers Wearing Hoods	Number of Workers Wearing Masks	Cooling Options
ADP20	11-31	4	6	Frigitron2000 (1 worker max)
EDP10	10	1	2	None
EDP16TE	16	2	4	None
EDP16HAZ	16	2	4	None
EDP30	30	4	6	Frigitron2000 (2 worker max)
EDP50	50	7	10	None

Thermal Overload Tips

- Always use 1/2" Connections
- Always use 1/2" ID Hose
- Only use Cool Tubes when compatible
- Never exceed recommended operating pressures
- Always use a heavy-duty extension cord



Free-Air® Pumps

Air-Driven Pumps - 30 cfm

ADP20

Air-Driven, Oil-Less Air Pump

- Supplies air to four hood-style respirators or six half- or full-face mask respirators
- 30 cfm at 5 psi with minimum 85 cfm at 95 psi incoming drive air pressure
- Outlet Pressure gauge (0-30 psig)
- Two 1/2" Industrial Interchange (Hansen compatible) quick-disconnect couplers
- Shipping Weight: 100 lbs.



ADP20 Replacement Parts

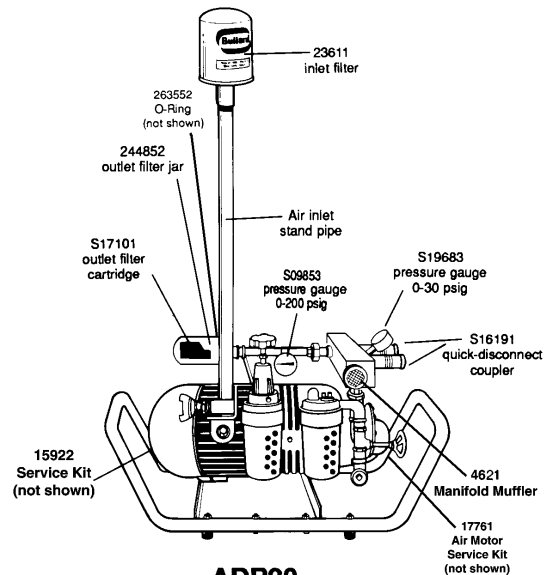

ADP20

17761

Service Kit for Air Motor

- Four carbon vanes
- Two motor bearings
- Four vane springs
- Seal
- Two body gaskets
- Two push pins
- End cap gasket
- O-ring



LUBREG

Lubricator Regulator



S09853

Incoming Pressure Gauge, 0-200 PSI



15922

Service Kit for Pump ADP20 and EDP16TE

- Four carbon vanes
- 23611 inlet filter
- S17101 outlet filter cartridge



Free-Air® Pumps

ADP20 Replacement Parts

4621 ADP20 Manifold Muffler



21052 Conversion Kit
• Conversion components - ADP16 or ADP3CA to ADP20



S19683 Outlet Pressure Gauge, 0-30 psi



S16191 Quick-Disconnect Coupler
• 1/2" Industrial Interchange (Hansen compatible), shut-off
• 3/8" NPT Pipe Thread



Free-Air® Pumps

ADP20 Replacement Parts

23611	Inlet Filter <ul style="list-style-type: none">• Change every 500 hours or as required• One required for EDP10, EDP16TE/HAZ, ADP20; two required for EDP30 & EDP50	
244852	Outlet Filter Jar	
263552	Outlet Filter Assembly O-Ring	
S17101	Outlet Filter <ul style="list-style-type: none">• Carbofine (change every 200 hours or as required)• One required for EDP10, EDP16TE/HAZ, ADP20; 4 required for EDP30; eight required for EDP50	
S17931	Cleaning Solvent, 14 oz. Aerosol Can	
V22	Quick-Disconnect Coupler Adapter <ul style="list-style-type: none">• Converts pump's quick-disconnect coupler to double 3/8" female NPT	
V23	Quick-Disconnect Adapter <ul style="list-style-type: none">• Converts pump's quick-disconnect coupler to single 3/8" female NPT	
V24	Quick-Disconnect Coupler Splitter/Adapter <ul style="list-style-type: none">• Converts pump's quick-disconnect coupler to double 1/2" Industrial Interchange female couplers (one flow through, one shut-off)	
V50IN	Remote Inlet Air Hose Kit <ul style="list-style-type: none">• 50-ft. length• Connects to pump for remote location of inlet filter• Maximum one per pump• 1 1/2" ID	
V50EX	Remote Extension Hose Kit <ul style="list-style-type: none">• 50-ft. length• Connects to V50IN to extend length• Maximum five per pump• 1 1/2" ID	



Free-Air® Pumps

Electric-Driven Pumps - 10 cfm

- EDP10HM** One- to Two-Person Pump (With Run Hour Meter)
EDP10 One- to Two-Person Pump
- ¾ HP electric-driven, oil-less air pump with open drip-proof motor drive
 - Supplies air to one hood-style or two half- or full-face mask airline respirators
 - Carrying handle
 - Inlet and outlet filter cartridges
 - Pressure gauge (0-30 psig)
 - Electrical cord and On/Off switch
 - One ½" Industrial Interchange (Hansen compatible) quick-disconnect coupler
 - Shipping Weight: 60 lbs.



- EDP1050HZ220VHM** One- to Two-Person Pump (With Run Hour Meter)
EDP1050HZ220V One- to Two-Person Pump
- 220V 50HZ version

EDP10 Replacement Parts

EDP10 Electrical Motor Specifications

- Enclosure: Open, Drip-proof
 Meets UL Requirements,
 CSA Approved
- Class: Natl. Elec. Code:
 Class B
 Design N
 Code K
- H.P. ¾
 Phase: Single
 Cycles: 60 Hz
 Volts: 115
 Amps: 10.2 @ 115 V
 Service Factor: 1.25
 Protector: Internal Thermal Overload

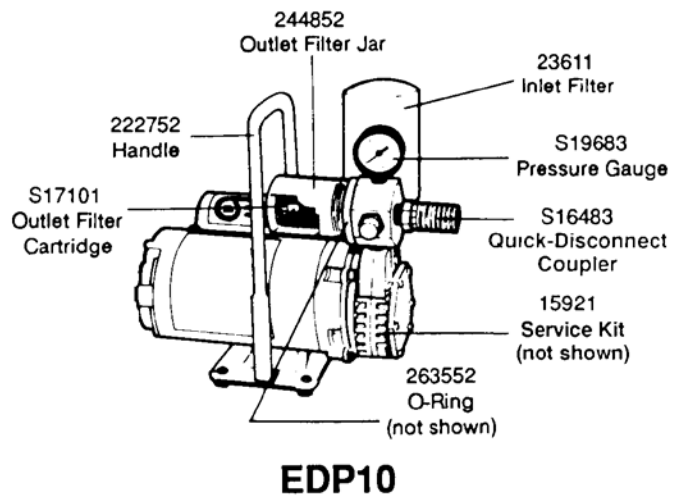





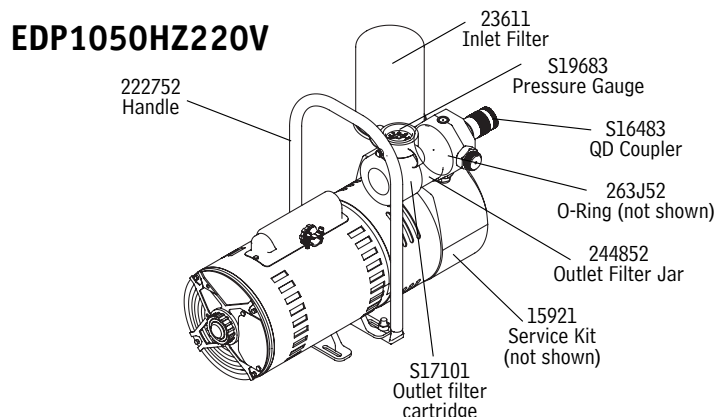











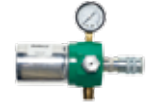

EDP10HZ220V Electrical Motor Specifications

- Enclosure: Open, Drip-proof
 Meets UL Requirements,
 CSA Approved
- Class: Natl. Elec. Code:
 Class B
 Design N
 Code K
- H.P. 1
 Phase: Single
 Cycles: 50 Hz
 Volts: 110/220
 Amps: 10 @ 110 V / 5.3 @ 220 V
 Service Factor: 1.15
 Protector: Internal Thermal Overload



Free-Air® Pumps

EDP10 Replacement Parts

15921	Service Kit for EDP10 <ul style="list-style-type: none"> • Four carbon vanes • 23611 inlet filter • S17101 outlet filter cartridge 	
15923	Service Kit for EDP1050HZ220V	
VANEEDP10	Vane Replacement Kit for EDP10 (set of 4 vanes)	
S19683 EDP10PRV	Pressure Gauge, 0-30 psi Pressure relief value	
S16483	Quick-Disconnect Coupler <ul style="list-style-type: none"> • 1/2" Industrial Interchange, flow-through • 3/4" NPT pipe thread 	
23611	Inlet Filter <ul style="list-style-type: none"> • Change every 500 hours or as required • One required for EDP10, EDP16TE/HAZ, ADP20; two required for EDP30 & EDP50 	
23612	For EDP2A retrofit kit	
23613	For EDP1A retrofit kit	
HEXADAPTOR	Bushing for EDP10 inlet filter	
244852	Outlet Filter Jar	
INLINE10	Inline Filter Assembly for remote re-locating of outlet	
263552	Outlet Filter Assembly O-Ring	
S17101	Outlet Filter <ul style="list-style-type: none"> • Carbofine (change every 200 hours or as required) • One required for EDP10, EDP16TE/HAZ, ADP20; four required for EDP30; eight required for EDP50 	
222752	Carrying Handle	
S17931	Cleaning Solvent, 14 oz. Aerosol Can	
V22	Quick-Disconnect Coupler Adapter <ul style="list-style-type: none"> • Converts pump's quick-disconnect coupler to double 3/8" female NPT 	
V23	Quick-Disconnect Adapter <ul style="list-style-type: none"> • Converts pump's quick-disconnect coupler to single 3/8" female NPT 	
V24	Quick-Disconnect Coupler Splitter/Adapter <ul style="list-style-type: none"> • Converts pump's quick-disconnect coupler to double 1/2" Industrial Interchange female couplers (one flow-through, one shut-off) 	

Free-Air® Pumps

- V50IN** Remote Inlet Air Hose Kit
- 50-ft. length
 - Connects to pump for remote location of inlet filter
 - Maximum one per pump
 - 1 1/2" ID



- V50EX** Remote Extension Hose Kit
- 50-ft. length
 - Connects to V50IN to extend length
 - Maximum five per pump
 - 1 1/2" ID



- V50INF** Remote Inlet Air Hose Fittings Kit



- HM** Run Hour Meter-Field Conversion Kit



Electric-Driven Pumps - 16 cfm

- EDP16TE** Two- to Three-Person Pump
- 1 1/2 HP electric-driven, oil-less air pump with totally enclosed fan-cooled motor drive (TFEC)
 - Supplies air to two hood-style or three half- or full-face mask airline respirators
 - Inlet and outlet filter cartridges
 - Pressure gauge (0-30 psig)
 - Electrical cord and On/Off switch
 - Two 1/2" Industrial Interchange (Hansen compatible) quick-disconnect couplers
 - Shipping Weight: 100 lbs



EDP16TE60HZ220V Same as EDP16TE wired for 220V, 60Hz

EDP16TEW EDP16TE pump with wheels for ease of mobility

WKIT16 Wheel Kit for EDP10 Pump, Field Conversion

EDP16TE Electrical Motor Specifications

- Enclosure:** Totally-Enclosed, Fan Cooled Capacitor Start
- Meets UL Requirements, CSA Approved
- Class:** Natl. Elec. Code: Class III Division 1 and 2
- H.P.:** 1.5
- Phase:** Single
- Cycles:** 60 Hz
- Volts:** 115/208/230 (Connected for 115 V.)
- Amps:** 16.0 @ 115 V
8.0 @ 208/230 V.
- Service Factor:** 1.15
- Protector:** Manual Reset Thermal Overload equipped for 115 volt operation.
- Thermal Overload and Starter/Contactor to be provided by the user if rewired to 208/230 volts.

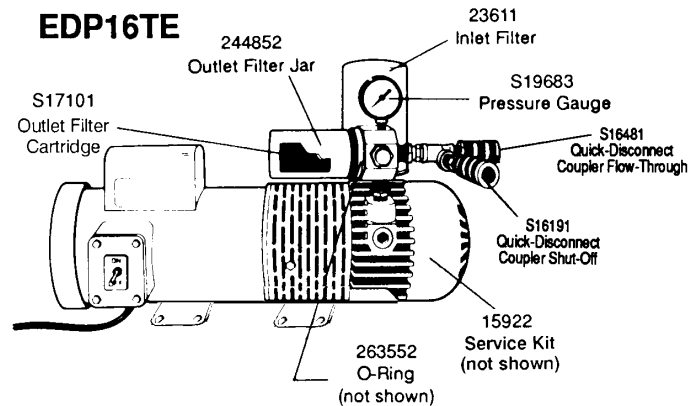

Free-Air® Pumps

EDP16HAZ/EDP16TE

- EDP16HAZ** Two- to Three-Person Hazardous Duty Pump (Not Pictured)
- 1 1/2 HP electric-driven, oil-less air pump with hazardous-duty motor (Explosion Proof)
 - Supplies air to two hood-style or three half- or full-face mask airline respirators
 - Inlet and outlet filter cartridges
 - Pressure gauge (0-30 psig)
 - Starter/contactor to be supplied by user
 - Two 1/2" Industrial Interchange (Hansen compatible) quick-disconnect couplers
 - Shipping Weight: 100 lbs.

- EDP16HAZ** 230V 50Hz
- For 50 Hz electric supply

- EDP16HAZW** 230V 50Hz
- With Wheels for ease of mobility

EDP16HAZ Electrical Motor Specifications

- Enclosure:** Hazardous Duty
Meets UL Requirements, CSA Approved
- Class:** National Electric Code:
Class I, Group D, Div. 1 & 2
Class II, Group F, Div. 1 & 2
Class II, Group G, Div. 1 & 2
Class III, Division 1 & 2<
- H.P.:** 1.5
Phase: Three
Cycles: 60 Hz
Volts: 230-460
Amps: 5.0 @ 230 V
2.5 @ 460 V
- Service Factor:** 1.0
Protector: Thermal Overload and Starter/Contactor to be provided by the user.

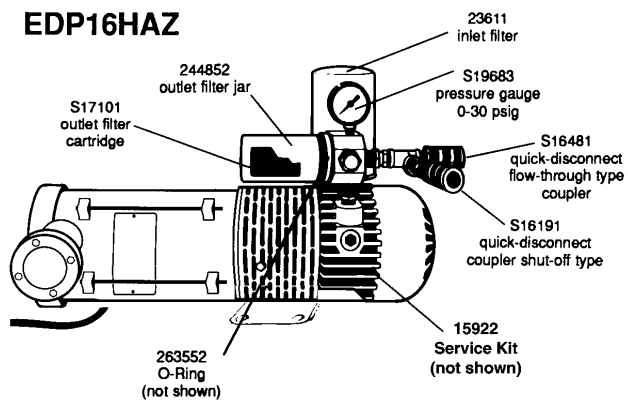

EDP16HAZ/EDP16TE Replacement Parts

- 15922** Service Kit for pumps ADP20 and EDP16TE
- Four carbon vanes
 - 23611 inlet filter
 - S17101 outlet filter cartridge



- S19683** Pressure Gauge, 0-30 psi



- INLINE16** Inline Filter Assembly for remote re-locating of outlet





- S16191** Quick-Disconnect Coupler
- 1/2" Industrial Interchange (Hansen compatible), shut-off
 - 3/8" NPT Pipe Thread
 - Red Band



Free-Air® Pumps

EDP16HAZ/EDP16TE Replacement Parts

S16481	Quick-Disconnect Coupler <ul style="list-style-type: none">• 1/2" Industrial Interchange (Hansen compatible), flow-through• 3/8" NPT Pipe Thread• Green Band	
---------------	--	---

23611	Inlet Filter <ul style="list-style-type: none">• Change every 500 hours or as required• One required for EDP10, EDP16TE/HAZ, ADP20; two required for EDP30 & EDP50	
--------------	---	---

244852	Outlet Filter Jar	
---------------	-------------------	---

263552	Outlet Filter Assembly O-Ring	
---------------	-------------------------------	---

S17101	Outlet Filter <ul style="list-style-type: none">• Carbofine (change every 200 hours or as required)• One required for EDP10, EDP16TE/HAZ, ADP20; four required for EDP30; eight required for EDP50	
---------------	---	---

S17931 Cleaning Solvent, 14 oz. Aerosol Can (not pictured)

V22	Quick-Disconnect Coupler Adapter <ul style="list-style-type: none">• Converts pump's quick-disconnect coupler to double 3/8" Female NPT	
------------	---	---

V23	Quick-Disconnect Adapter <ul style="list-style-type: none">• Converts pump's quick-disconnect coupler to single 3/8" Female NPT	
------------	---	---

V24	Quick-Disconnect Coupler Splitter/Adapter <ul style="list-style-type: none">• Converts pump's quick-disconnect coupler to double 1/2" Industrial Interchange female couplers (one flow through, one shut-off)	
------------	---	---

V50IN	Remote Inlet Air Hose Kit <ul style="list-style-type: none">• 50-ft. length• Connects to pump for remote location of inlet filter• Maximum one per pump• 1 1/2" ID	
--------------	---	---

V50EX	Remote Extension Hose Kit <ul style="list-style-type: none">• 50-ft. length• Connects to V50IN to extend length• Maximum five per pump• 1 1/2" ID	
--------------	--	---

Free-Air® Pumps

Electric-Driven Pumps - 30 cfm

Electric Driven, Oil-less Air Pump

- All motors are open drip-proof
- Supplies air to:
 - Four hood-style; or
 - Six half- or full-face mask airline respirators; or
 - Two hood-style respirators equipped with FRIGITRON climate control devices.
- Respirators must be approved to operate on 30 psig or less
- Shipped complete with inlet and outlet filter cartridges, pressure gauges, pressure relief valves and one air supply hose quick-disconnect pod with six 1/2" Industrial Interchange (Hansen compatible) quick-disconnect couplers
- Three phase motors come standard with protective reversing starters to prevent running backwards
- Shipping weight: 292 lbs.



NOTE: EDP30 pumps are custom built to your specifications. Contact Bullard Customer Service for lead time information

-
- EDP30A208** Single Phase 5 HP Motor, 208 Volt
 - EDP30A230** Single Phase 5 HP Motor, 230 Volt
 - EDP30B208** Three Phase 5 HP Motor, Reversing Starter, 208 Volt
 - EDP30B230** Three Phase 5 HP Motor, Reversing Starter, 230 Volt
 - EDP30B460** Three Phase 5 HP Motor, Reversing Starter, 460 Volt
 - EDP30C230** Three Phase 7.5 HP Motor, Reversing Starter, 230 Volt
 - EDP30C460** Three Phase 7.5 HP Motor, Reversing Starter, 460 Volt

Electric-Driven Pumps - 50 cfm

Electric Driven, Oil-less Air Pump

- All motors are open drip-proof
- Supplies air to:
 - Seven hood-style; or
 - Ten half- or full-face mask airline respirators
- Respirators must be approved to operate on 15 psig or less
- Shipped complete with inlet and outlet filter cartridges, pressure gauges, pressure relief valves and two air supply hose quick-disconnect pods with six 1/2" Industrial Interchange (Hansen compatible) quick-disconnect couplers
- Three phase motors come standard with protective reversing starters to prevent running backwards.
- Shipping weight: 317 lbs.



NOTE: EDP50 pumps are custom built to your specifications. Contact Bullard Customer Service for lead time information.

-
- EDP50A208** Single Phase 5 HP Motor, 208 Volt
 - EDP50A230** Single Phase 5 HP Motor, 230 Volt
-
- EDP50B208** Three Phase 5 HP Motor, Reversing Starter, 208 Volt
 - EDP50B230** Three Phase 5 HP Motor, Reversing Starter, 230 Volt
 - EDP50B460** Three Phase 5 HP Motor, Reversing Starter, 460 Volt
-
- EDP50C208** Three Phase 7.5 HP Motor, Reversing Starter, 208 Volt
 - EDP50C230** Three Phase 7.5 HP Motor, Reversing Starter, 230 Volt
 - EDP50C460** Three Phase 7.5 HP Motor, Reversing Starter, 460 Volt

Free-Air® Pumps

EDP30 and EDP50 Replacement Parts

- V60** Pod Extension Hose
- 100 Feet
 - 1 1/4" ID
 - Three per pod maximum



-
- 26701** Pod Gasket (Filter Side)



-
- 27161** Pod Gasket (Cover Side)



-
- 26781-EDP30** Pod Assembly
26781-EDP50 Pod Assembly

Helpful hint: Pod Assemblies allow the point of connection to be moved closer to the worker while still keeping the pump at an optimal distance for noise, fresh-air, etc.



-
- 28151** EDP30 Pressure Relief Valve



-
- 28152** EDP50 Pressure Relief Valve



-
- S16191** Quick-Disconnect Coupler
- 1/2" Industrial Interchange (Hansen compatible), shut-off
 - 3/8" NPT pipe thread





Free-Air® Pumps

EDP30 and EDP50 Replacement Parts

S19683 Pressure Gauge, 0-30 psi
• For EDP30 and EDP50 pod



S19688 Pressure Gauge, 0-60 psi
• For EDP30 and EDP50 manifold



S2084 EDP30 Drive Belt (Matched Pair)



S2089 Kamlok Adapter (Pod)
• 1 1/4" ID aluminum



S2090 Kamlok Coupler (Manifold)
• 1 1/4" ID aluminum







15924 Service Kit
• Four carbon vanes
• Two bearings
• Two cover gaskets



Free-Air® Pumps

EDP30 and EDP50 Replacement Parts

23611	Inlet Filter <ul style="list-style-type: none">• Change every 500 hours or as required• One required for EDP10, EDP16TE/HAZ, and ADP20; two required for EDP30 & EDP50	
244852	Outlet Filter Jar	
263552	Outlet Filter Assembly O-Ring	
S17101	Outlet Filter <ul style="list-style-type: none">• Carbofine (change every 200 hours or as required)• One required for EDP10, EDP16TE/HAZ, ADP20; four required for EDP30; eight required for EDP50	
S17931	Cleaning Solvent, 14 oz. Aerosol Can	
V22	Quick-Disconnect Coupler Adapter <ul style="list-style-type: none">• Converts pump's quick-disconnect coupler to double 3/8" Female NPT	
V23	Quick-Disconnect Adapter <ul style="list-style-type: none">• Converts pump's quick-disconnect coupler to single 3/8" Female NPT	
V24	Quick-Disconnect Coupler Splitter/Adapter <ul style="list-style-type: none">• Converts pump's quick-disconnect coupler to double 1/2" Industrial Interchange female couplers (one flow through, one shut-off)	
V50EX	Remote Extension Hose Kit <ul style="list-style-type: none">• 50-ft. length• Connects to V50IN to extend length• Maximum five per pump• 1 1/2" ID	
V50IN	Remote Inlet Air Hose Kit <ul style="list-style-type: none">• 50-ft. length• Connects to pump for remote location of inlet filter• Maximum one per pump• 1 1/2" ID	

Part Number Product Index

Part Number Page Number

6S24.....5, 35, **42**
 8S24.....5, 35, **42**
 9CP.....16
 9CR.....16
 9HP.....16
 9HR.....16
 13VX.....117, 127, 128,
 129, **134**
 20BT.....84, 94, 95, 96, 97,
 98, 100, 104, 105,
 108, 111, 112,
 113, 120, 121,
 131, 132, 140,
 145, 146
 20LC.....147
 20LCL.....76, 84, 87, **91**
 20LCLBP.....76, **91**
 20LF2L.....57, 59, 67, **72**,
 100, **102**
 20LF2M.....57, 59, 67, **72**,
 100, **102**
 20LF2S.....57, 59, 67, **72**,
 100, **102**
 20LFBT.....95, 96, 97, **98**,
 103, 104, 105,
 106, 112, 121,
 131, 132
 20LFL.....57, 59, 67, **72**,
 87, 100, **102**
 20LFM.....57, 59, 67, **72**,
 100, **102**
 20NC.....57, **76**, 84, **91**,
 117, 127, **135**,
 140, **142**
 20QCBTC.....**80, 98, 106, 113**
 20RT.....57, **76**, 84, **91**,
 140, **142**
 20SIC.....61, 69, **74, 90**
 20SICH.....57, **74**, 84, **90**
 20SICH30R.....**74, 90**
 20SICH51R.....**74, 90**
 20SICHT.....57, **74**
 20SICHTC30R.....74
 20SICHTS51RT.....74
 20SICN.....57, **74**, 84, 86, **90**
 20SICNT.....57, **74**
 20SICNX.....**74, 90**
 20SICNXT.....74
 20SICT.....69, **74**
 20SICV.....**74, 90**
 20SICVH.....**74, 90**
 20SICVHC30R.....74
 20SICVHS51R.....**74, 90**
 20SICVHT.....74
 20SICVHTC30R.....74
 20SICVHTS51R.....74
 20SICVN.....**74, 90**
 20SICVNT.....74
 20SICVT.....74
 20SLBTC.....**80, 98, 106, 113**
 20TG.....76, 85, 86, 87,
 91, 141, **142**
 20TIC.....60, 68, **72, 88**
 20TICH.....57, 60, 68, **73**,
 84, 86, 87, **89**
 20TICH30R.....73
 20TICH51R.....**73, 89**
 20TICHT.....57, **73**
 20TICHTC30R.....73
 20TICHTS51R.....73
 20TICN.....57, **72**, 84, 85,
 87, **88**
 20TICNT.....72
 20TICNX.....**72, 88**
 20TICNXT.....72
 20TICS.....60, 68, **73, 89**

20TICSNT.....57, **73**
 20TICST.....60, 68, **73**
 20TICT.....72
 20TJ.....60, 68, **72, 88**
 20TJN.....57, **72**, 84, 85, **88**
 20TJNT.....72
 20TJT.....72
 20TP.....60, 68, **72, 88**
 20TPC.....60, 68, **73, 89**
 20TPCN.....57, **73**, 84, 85, **89**
 20TPCNT.....57, **73**
 20TPCT.....60, 68, **73**
 20TPN.....57, **72**, 84, 85, **88**
 20TPNT.....72
 20TPT.....72
 28VX.....117, 118, 119, **122**
 30BSW.....**180, 181**
 30P.....15
 30R.....15
 30SSW.....**180, 181**
 30SW.....**180, 181**
 33P.....15
 33R.....15
 34P.....15
 34R.....15
 36VX.....117, 127, 129, **134**
 36XLVX.....117, 127, **134**
 38VX.....117, **122**
 41A.....185, **186**
 41ACAB.....194
 41ACABKIT.....**187, 194**
 41AF.....186
 41Drain.....187
 41HK.....186, **187**
 41KB2.....187
 41P2.....185, **186, 187**
 41P2M.....187
 41P2R.....187
 41P2WM.....186
 41P6.....185, **186, 187**
 41P6R.....187
 41P6UPK.....187
 41P6WM.....185, **186**
 41PRV.....187, 194
 41RG.....187
 46VX.....117, 127, 128,
 129, **134**
 51P.....18
 51R.....18
 61P.....18
 61R.....18
 62P.....18
 62R.....18
 71P.....18
 71R.....18
 77GLT.....137
 77LG.....137
 88CA.....136
 88CK.....133
 88CS.....136
 88VX36XL30.....129
 88VX1330.....128
 88VX1335.....129
 88VX3230.....**128, 189**
 88VX3230H.....128
 88VX3231.....128
 88VX3235.....129
 88VX3235H100.....129
 88VX3240.....128
 88VX3630.....129
 88VXAK.....136
 88VXBAIL.....136
 88VXBT.....95, 96, 97, 104,
 105, 112, 117,
 120, 121, 127,
 131, 132, **133**
 88VXHP.....136

88VXLC.....117, 127, **137**
 88VXOLT.....138
 88VXOLTG.....138
 88VXRTP.....117, 127, **135**
 88VXSYS.....129
 88VXSYS16TE.....129
 88VXTGP.....136
 100G.....38
 110G.....38
 112G.....38
 300B.....37
 300BW.....37
 312B.....37
 400.....37, 43
 400W.....6, **37**
 500M.....38
 640.....5, **40**
 640G.....39
 640PW3.....5, 35, **41**
 640PW5.....5, 35, **41**
 680P.....5, 35, **40, 41**
 680T.....5, 35, **39**
 840M.....40
 840ME.....39, **42**
 840MG.....39
 840MH.....40
 840MX2.....36
 840P.....39
 840PW3.....5, 35, **41**
 840PW5.....5, 35, **41**
 840PX2.....36
 840PX2W3.....5, 35, **36**
 840PX2W5.....5, 35, **36**
 840T.....5, 35, **39**
 840TX2.....5, 35, **36**
 860H.....40
 860P.....5, 35, **41**
 860T.....5, 35, **39**
 880P.....41
 880T.....5, 35, **39**
 911CP.....16
 911CR.....16
 911HP.....16
 911HR.....16
 1040.....40
 3420.....177
 3421.....176
 3422.....177
 3902.....177
 3914.....176
 4611.....162
 4612.....84, 85, 86, 87, 94,
 98, 100, 101, 103,
 106, 108, 109,
 111, 112, **113**,
 117, **122**, 127,
 130, **133**, 140,
 145, 146, **147**,
 153, **170, 180**,
 181, **183**
 4621.....197
 4696.....128, **173**
 5454.....174
 5457.....174
 5458.....174
 6059.....151, **155**
 7714.....127, **137, 147**
 15921.....200
 15922.....196, **202**
 15923.....200
 15924.....206
 17761.....196
 21052.....197
 21821.....127, **134**

23611.....196, **198**,
 200, 202,
 203, **207**
 23612.....200
 23613.....200
 26701.....205
 26781-EDP30.....205
 26781-EDP50.....205
 27161.....205
 28151.....205
 28152.....205
 30013.....21
 36501.....84, **98**,
 100, **106**,
 108, **113**,
 170
 46913.....173
 46915.....173
 46916.....173
 46917.....173
 46918.....173
 46919.....173
 54510.....174
 54511.....174
 54512.....174
 54513.....174
 54514.....174
 222752.....200
 244852.....**198, 200**,
 203, **207**
 263552.....198,
 200,
 203,
 207
 272556.....180
 469650.....173
 4696100.....152,
 173
 A1.....8, 30
 A1S.....8
 A2.....8, 10, 30
 A2S.....8
 A101.....11
 A110.....8, **12**
 AC1000DC.....182
 AC100030.....84, 100,
 108, 117,
 127, 140
 AC100030B.....84, 100,
 108, 117,
 127, 140
 AC100030S.....84, 100,
 108, 117,
 127, 140
 AC100031.....84, 100,
 108, 117,
 127, 140, **180**
 AC100032.....84, 100,
 108, 117,
 127, 140, **180**
 AC100033.....84, 100,
 108, 117,
 127, 140, **180**
 AC100034.....84, 100,
 108, 117,
 127, 140, **180**
 AC100037.....84, 100,
 117, 127,
 140, **180**
 AC100038.....117, 127,
 180
 ADFB.....12

*Bold indicates product key page

INDEX

Part Number	Page Number				
ADP20.....	129, 195, 196 , 197, 198, 200, 203, 207	CAB50PMHA.....	191	COHPAK.....	189 , 193
ADRTSL.....	7, 8, 11	CAB50PMIR.....	191	COHPCC.....	189
AFW45.....	156 , 165	CAB100.....	188	COHPKIT.....	193
B1.....	33	CAB100FA.....	194	COM5.....	193
B2.....	33	CAB100FB.....	194	COM10.....	193
B88VXLC.....	137	CAB100FC.....	194	CP1.....	36
B771B.....	138	CAB100FCIA.....	194	CP2.....	36
B771D015.....	138	CAB100FCIC.....	194	CS40.....	40
B771R.....	138	CAB100FEA.....	194	CSS.....	22
B771R015.....	138	CAB100FEB.....	194	CT30.....	117, 118, 127, 180
B771R020.....	138	CAB100FEC.....	194	CT30B.....	117, 127, 180
B771020.....	138	CAB100FK.....	194	CT30BSW.....	117, 127, 180
B771040.....	138	CAB100IRHA.....	190	CT30S.....	117, 127, 180
BC.....	23, 24	CAB100MB.....	194	CT30SSW.....	117, 127, 180
BCHBP.....	24	CAB100PM.....	191	CT30SW.....	117, 127, 180 , 181
BCHBV.....	24	CAB100PMIR.....	191	CT31.....	117, 118, 127, 180
BCP.....	24	CAB100PMIRHA.....	191	CT32.....	117, 127, 180
BCRBPP.....	24	CABCALREG.....	193	CT33.....	117, 127, 180
BCRBPV.....	24	CABCALREG103.....	193	CT34.....	117, 127
BCV.....	24	CABCG0.....	193	CT37.....	117, 127, 180
BFW.....	137	CABCG10.....	193	CT38.....	117, 127, 180
BGVXIL.....	124	CABCG017L.....	193	CTF.....	180
BGVXOL15.....	124	CABCG0103L.....	193	CYL5H.....	160
BGVXOL40.....	124	CABCG1017L.....	193	CYL10H.....	160
BHA.....	158, 162	CABCG10103L.....	193	CYL455.....	160
BT100.....	152, 153	CABCK.....	193	CYL4510.....	160
BT101.....	153	CABCK17L.....	193	DC70ML.....	84, 100, 108, 117, 127, 140, 150, 182
BT102.....	153	CABCK103L.....	193	DC70XLXL.....	84, 100, 108, 117, 127, 140, 150, 182
BT103.....	153	CABCORDAU.....	194	DC705XL.....	84, 100, 108, 117, 127, 140, 182
BT108.....	153	CABCORDEU.....	194	DC5040.....	84, 100, 108, 117, 127, 140, 182 , 183
BT135.....	152, 153	CABCORDJA.....	194	DC5040B.....	84, 100, 108
C20LFL35.....	101	CABCORDEU.....	194	DC5040S.....	84, 100, 108
C30P.....	15, 140	CABCORDUK.....	194	DC5041.....	84, 100, 108, 117, 127, 140, 182
C30R.....	15, 57, 77, 84, 86, 87, 92 , 143	CABFR.....	194	DC5042.....	84, 100, 108, 117, 127, 140, 182
C33P.....	15	CABKS.....	193	DC5043.....	84, 100, 108, 182
C34R.....	15	CABPC.....	194	DC5044.....	84, 100, 108, 117, 127, 182
CA30.....	158, 160, 161	CABQDCAP.....	194	DC5047.....	84, 100, 108, 117, 127, 140, 182
CA31.....	161	CABQDCE.....	194	DC5048.....	182
CA32.....	161	CABQDHA.....	194	DCHS.....	182
CA33.....	161	CABQDNV.....	194	E840ME.....	5, 35, 42
CA34.....	161	CABQDSC.....	194	ECB.....	22, 26
CA37.....	161	CABQDSN.....	194	ECCN.....	22, 26
CAB15.....	188, 190 , 191	CABQDSS.....	194	ECVL.....	44
CAB15FCI.....	194	CABQDSS.....	194	ECVXL.....	44
CAB15HA.....	190	CABREG1.....	194	EDP10.....	87, 141, 152, 168, 195, 198, 199 , 200, 203, 207
CAB15HA88VXSYS.....	189 , 190, 191, 192	CABREG2.....	194	EDP10HM.....	199
CAB15HA88VXSYS5.....	189 , 190, 191	CABREG3.....	194	EDP10PRV.....	200
CAB15HASYS.....	189	CABREG4.....	194	EDP16HAZ.....	195, 202 , 203
CAB15HASYS5.....	189	CABREGTB.....	193	EDP16HAZW.....	202
CAB15PM.....	191	CABRS.....	193	EDP16TE.....	129, 195, 198, 200, 201 , 202, 203, 207
CAB15RAUPGRADE.....	190 , 191	CABRS2.....	193	EDP16TE60HZ220V.....	201
CAB30.....	188, 190 , 191 , 194	CC20LF2L30.....	101	EDP16TEW.....	201
CAB30FA.....	193	CC20LF2M30.....	101	EDP30A208.....	204
CAB30FB.....	193	CC20LF2S30.....	101	EDP30A230.....	204
CAB30FC.....	193	CC20LF35.....	87	EDP30B208.....	204
CAB30FCI.....	194	CC20LFL30.....	101		
CAB30FEA.....	193	CC20LFM30.....	101		
CAB30FEB.....	193	CC20LFM35.....	101		
CAB30FEC.....	193	CC20SIC30.....	86		
CAB30FEA.....	193	CC20SYS.....	87 , 101		
CAB30FEB.....	193	CC20TIC35.....	87 , 101		
CAB30FEC.....	193	CC20TICH30.....	86		
CAB30FK.....	193	CC20TICH30S51.....	86		
CAB30IRHA.....	190	CC20TICH35.....	87		
CAB30PM.....	191	CC20TJ30.....	85		
CAB30PMIR.....	191	CC20TP30RT.....	85		
CAB50.....	188, 190 , 191 , 194	CH60.....	182		
CAB50FA.....	194	CH1000.....	182, 183		
CAB50FB.....	194	C05HP.....	189		
CAB50FC.....	194	C05HP41P2.....	185 , 189		
CAB50FCIA.....	194	C05HP41P2CABCK.....	185 , 189		
CAB50FCIB.....	194	C05HP41P2WMCABCK.....	185 , 189		
CAB50FEA.....	194	C05HP41P6.....	185 , 189		
CAB50FEB.....	194	COHP.....	189		
CAB50FEC.....	194	COHP41P2.....	185, 188, 189		
CAB50FEA.....	194	COHP41P2CABCK.....	185 , 189		
CAB50FEB.....	194	COHP41P2CC20.....	185		
CAB50FEC.....	194	COHP41P2WMCABCK.....	185 , 189		
CAB50FK.....	194	COHP41P6.....	185, 188, 189		
CAB50PM.....	191	COHP41P288VX.....	185		

EVAHL6 70
 EVAHL7 70
 EVAHL2OLF2L 67
 EVAHL2OLF2M 67
 EVAHL2OLF2S 67
 EVAHL2OLFL 67
 EVAHL2OLF 67
 EVAHL2OSIC 69
 EVAHL2OSICH 68
 EVAHL2OSICHT 68
 EVAHL2OSICT 69
 EVAHL2OTIC 68
 EVAHL2OTICH 68
 EVAHL2OTICHT 68
 EVAHL2OTICS 68
 EVAHL2OTICST 68
 EVAHL2OTICT 68
 EVAHL2OTJ 68
 EVAHL2OTJT 68
 EVAHL2OTP 68
 EVAHL2OTPC 68
 EVAHL2OTPCT 68
 EVAHL2OTPT 68
 EVAHLFAML 69
 EVAHLFAMM 69
 EVAHLFAMS 69
 EVAHLGC 57, **70**
 EVAHLPAN1 67
 EVAHLPAN2 67
 EVAHLRT3 68
 EVAHLRT3T 68
 EVAHLRT4 69
 EVAHLRT4T 69
 EVAHLSMC 57, 62, **70**
 EVAHLSMC2 57, 62, **70**
 EVAHLSMCAU 70
 EVAHLSMCEU 70
 EVAHLSMCPS 70
 EVAHLSMCIUK 70
 EVAHLSPECL 69
 EVAHLSPECS 69
 EVALLKIT **63, 71**
 EVAPAN1 **59, 67**
 EVAPAN2 **59, 67**
 EVART1 60
 EVART1T 60
 EVART2 61
 EVART2T 61
 EVART3 **60, 68**
 EVART3T 60
 EVART4 61, 69
 EVART4T 61
 EVASMC 57, **62, 70**
 EVASMC2 57, **62, 70**
 EVASMCAU **62, 70**
 EVASMCEU **62, 70**
 EVASMCPS 62
 EVASMCUK **62, 70**
 EVASPECL **61, 69**
 EVASPECS **61, 69**
 EVO 151, **156, 165**
 EVPDK **154, 159, 163**
 EVX30 130
 EVX31 130
 EVX32 130
 EVX33 130
 EVX35 130
 EVX37 130
 EVX38 130
 EVX40 130
 EVX41 130
 EVX42 130
 EVX43 130
 EVX47 130
 EVX48 130

F30 84, 85, 86, 94,
95, 100, 103,
104, 108, 109,
 111, **112, 117,**
 118, **120, 127,**
 128, 129, 130,
131, 140, 141,
 145, 146, 168
 F30B 84, **95, 100, 104,**
 108, 117, 127,
 140
 F30S 84, **95, 100, 104,**
 108, 117, 127,
 140
 F30SD **95, 104**
 F30VDB **95, 104**
 F31 84, 94, **95, 100,**
 103, **104, 108,**
 111, **112, 117,**
120, 127, 128,
 130, **131, 140**
 F32 84, 94, **95, 100,**
 103, **104, 108,**
 111, **112, 117,**
120, 127, 130,
131, 140
 F33 84, 94, **95, 100,**
 103, **104, 108,**
 111, **112, 117,**
120, 127, 130,
131, 140
 F34 84, **95, 100, 104,**
 108, 111, **112,**
 117, 127, 140
 F35 84, 87, 94, **96,**
 100, 103, **105,**
 108, 117, **121,**
 127, 129, 130,
132, 140, 141,
 145, 146, 168
 F35B 84, **96, 100, 105,**
 117, 127, 140
 F37 84, **96, 100, 105,**
 117, **120, 127,**
 130, **131, 140**
 F38 117, **120, 127,**
 130, **131**
 F40 84, 94, **96, 100,**
 103, **105, 108,**
 117, **121, 127,**
 128, **132, 140,**
 145, **146**
 F40B 84, **96, 100, 105,**
 117, 127, 140
 F40S 84, **96, 100, 105,**
 108, 117, 127, 140
 F40VDB **96, 105**
 F41 84, 94, **96, 100,**
105, 108, 117,
121, 127, 132, 140
 F42 84, 94, **97, 100,**
 108, 117, **121, 127,**
132, 140, 150
 F43 84, 94, **97, 100,**
 108, 117, 127,
 140, 150
 F44 84, **97, 100, 108,**
 117, 127, 140, 150
 F47 84, **97, 100, 117,**
121, 127, 132,
 140, 150
 FAM2CB 169
 FAM2EVC 169
 FAM2EVF10 169
 FAM2L 169
 FAM2M **75, 169**
 FAM2S **75, 169**

FAMAK 170
 FAMB2T2C 170
 FAMB2T3C 170
 FAMB230L 168
 FAMB230M 168
 FAMB230S 168
 FAMB235L 168
 FAMB235M 168
 FAMB235S 168
 FAMB3SYS 168
 FB2000 25
 FB2001 25
 FBFOAM 25
 FBINSHELL 25
 FKML 151, **155, 159,**
164
 FKS 151, **155, 159,**
164
 FRIGITRON2000 180
 FRIGITRON2000B 108, 117, 127, 140
 180
 FRS6PC 16, **19, 26**
 FRS6RC 16, **19, 26**
 FSR45 160
 FTR45 **157, 166**
 G1 33
 G2 33
 G7713 137
 GC100 **21, 26**
 GGVS 117, **122**
 GR50SYS 141
 GR5030 141
 GR5035 141
 GRH **75, 140, 141,**
142
 GRHOL1 140, **147**
 GRHT **57, 75**
 GRHT30R 75
 GRHTS51R 75
 GVX1330 118
 GVX2830 118
 GVX2830AC1000 118
 GVX2830CT 118
 GVX2830HC2400 118
 GVX2830HCT 118
 GVX2831AC1000 118
 GVX2831CT 118
 GVX2835 119
 GVX2840 118
 GVX3830 118
 GVX3830AC1000 118
 GVX3830CT 118
 GVX3830HC2400 118
 GVX3830HCT 118
 GVX3840 118
 GVXPK30AC1000 118
 GVXPK30CT 118
 GVXPK30HC2400 118
 GVXPK30HCT 118
 GVXPK30XLCT 118
 GVXPK40 118
 GVXBT 95, 97, 104, 105,
 112, 117, **119,**
 120, 121, **122,**
 131, 132, 145,
 146
 GVXCA 123
 GVXCP 117, **123, 136**
 GVXCS 117, 118, 119,
123
 GVXCT 122
 GVXDMK 123
 GVXHP 123
 GVXIL 124
 GVXLC 117, **124**
 GVXOL15 124
 GVXOL40 124

GVXOLG 124
 GVXOLT 124
 GVXPL 117, **123**
 GVXRT 117, **123**
 GVXSYS 119
 GVXSYS16TE 119
 HC2400 **181, 182**
 HC240030 84, 100,
 108, 140
 HC240030B 84, 100,
 108, 140
 HC240030S 84, 100,
 108, 140
 HC240031 84, 100,
 108, 140,
181
 HC240032 84, 100,
 108, 140,
181
 HC240033 84, 100,
 108, 140,
181
 HC240034 84, 100,
 108, 140
 HC240037 84, 100,
 140, **181**
 HC240038 181
 HCT30 181
 HCT30B 181
 HCT30BSW 181
 HCT30S 181
 HCT30SSW 181
 HCT30SW 180, **181**
 HCT31 181
 HCT32 181
 HCT33 181
 HCT37 181
 HCT38 181
 HEXADAPTOR 200
 HFC45 **157, 166**
 HM 201
 HS **180, 181,**
183
 HSK **151, 156,**
 159, **165**
 I5 33
 INLINE10 200
 INLINE16 202
 IO 33
 ISO2 44
 ISO2P 44
 ISO2V 44
 ISO2XL 44
 ISO2XLV 44
 ISOC2 44
 ISOC2V 44
 L99BT 95, 96,
 97, 104,
 105, 112,
 120, 121,
156, 165
 LCK 151, **155,**
 159, **164**
 LNK 151, **154,**
 159, **163**
 LUBREG 196
 MB1 140, 141,
 142, **147**
 MCK 151, **156,**
 159, **165**
 MKHB 24
 MP771020 138
 MP771B 138
 O1 33

Part Number	Page Number						
O2	33	RAM4IRHA	192	SENTINEL1	36	V25HA	194
O7	33	RAM8	188, 192	SENTINEL2	36	V27	176
OR145	13	RAM8IR	192	SG	33	V30	85, 86, 94, 109, 111, 141, 145
OR308	13	RAM8IRHA	192	SO	33	V31	94, 111
OR309	13	RBPCOOL	15, 18, 19, 20, 21, 76, 77, 78, 91, 92, 93, 123, 135, 142, 143, 144	SPEC35L	152	V32	94, 111
OR310	13			SPEC35S	152	V33	94, 111
OR311	13			SPEC40L	152	V34	111
OR315	13			SPEC40S	152	V35	87, 94, 141, 145
OR316	13	RBPCOTTON	15, 16, 18, 19, 20, 21, 76, 77, 78, 91, 92, 93, 123, 135, 142, 143, 144	SPECCFML	152, 153	V40	94, 145
OR320	13			SPECCFS	152, 153	V41	94
P771B	138			SPECIVK	151, 155, 159, 164	V42	94
P771R	138			SPECLCABSYS	152, 189	V43	94
P771020	138	RBPVINYL	15, 18, 19, 20, 21, 76, 77, 78, 91, 92, 93, 123, 135, 142, 143, 144	SPECLCABSYS2M	152	V50EX	198, 201, 203, 207
PA1AFI	80			SPECLCABSYS5	189	V50IN	198, 201, 203, 207
PA1BT	57, 79			SPECLSYS	152	V60	205
PA1BTS4	80			SPECLSYS2M	152	V1000	180, 181, 182, 183
PA1BTXL	57, 79	RLS	151, 154, 159, 163	SPECLSYS50	152	V2025SSTSHUTOFF	174
PA1BTXS	57, 79	RS4PC	18, 20	SPECPE5L	158, 160	V2050ST	87, 129, 152, 174
PA3IS	57	RS4PP	18, 20	SPECPE5S	158	V20100ST	87, 129, 141, 152, 168, 174
PA4AFI	80	RS4RC	18, 20, 78, 93, 144	SPECPE10L	158	VANEEDP10	200
PA4BT	57, 79	RS4RP	18, 20, 77, 92, 143	SPECPE10S	158	VECTOR-C	10
PA20LFBT	57, 79	RS6PC	15, 16, 19	SPECPDLA	158	VECTOR-CRT	10
PA20LFBTXL	57, 79	RS6RC	15, 19, 77, 78, 92, 93, 143, 144	SPECPDS	158, 163	VT600	9, 10, 11
PA20LFBTXS	79	RT1	57, 60, 73, 107, 108, 110	SPECPSA	158	VTP	10
PA30	72, 73, 74, 79, 80, 88, 89, 90, 102	RT1DA	110	SR	33	VTR	10
PA30IS	72, 73, 74, 79, 80, 88, 89, 90, 102	RT1T	57, 60, 73	SS5	22	VTRT600	10, 11
PAFAMBT	57, 79	RT2	57, 61, 107, 108, 110	SS6	22	VTS	11
PAHBT	57, 79	RT2DA	110	ST1R	33, 34	W1	33
PAHBTXL	57, 79	RT3	57, 60, 68, 73, 107, 109, 110	ST1R500	33, 34	W2	33
PAHBTXS	57, 79	RT3DA	110	ST1RBLU	33	WKIT16	201
PAPRBAG	80	RT3T	57, 60, 68, 73	ST1RGRN	33	WS60PM	41
PAPRFC3	62, 70	RT4	57, 61, 69, 107, 108, 109, 110	ST1RORG	33	WS60TM	5, 35, 39
PAPRFC4	62, 70	RT4DA	110	ST1RORG175	33, 34	X30	103
PAPRFC5	57, 62	RT330	109	ST1RRED	33	X31	103
PAPRPFCOVER	63, 71	RT430	109	ST1RWHT	33	X32	103
PAPRPF40CP	62, 70	RTBT	108, 110, 112, 113	ST1RYLW	33	X33	103
PAPRPF41CP	62, 70	RTLCL	76, 108, 113	ST2R	33	X35	87, 103
PAPRPF2	57, 63, 71	S4	33	ST2RBLU	33, 34	X40	103
PAPRSC2	63, 71	S5	33, 34	ST2RGRN	33, 34	Y2	33
PAPRSC3	63, 71	S51P	18, 77, 86, 92, 140, 143	ST2RORG	33, 34		
PAPRSUSP1	63, 71	S51R	18, 57, 60, 68, 84, 92, 140	ST2RRED	33, 34		
PASPEC	57	S61P	18	ST2RWHT	33, 34		
PASPECMCL	75	S61R	18	ST2RYLW	33, 34		
PASPECS	57, 75	S62P	18	STRSS	33, 34		
PDR45	158, 160	S71P	18	STRSS500	33, 34		
PDR45B	160	S2084	206	STRSSBLU	33		
PKVX	117, 118, 122	S2089	206	STRSSGRN	33		
PKXLVX	122	S09853	196	STRSSORG	33		
PL	156, 165	S16191	197, 202, 205	STRSSORG175	33, 34		
PMFC2	170	S16481	203	STRSSRED	33		
POLYBTC	80, 98, 106, 113	S16483	200	STRSSWHT	33		
PPEBAG	80	S17101	196, 198, 200, 202, 203, 207	STRSSYLW	33		
QNFT45	157, 166	S17456	194	SW	33		
R1	33	S17931	198, 200, 203, 207	TT3	11, 26, 36		
R2	33	S18051	94, 98, 111, 113, 145, 146	UBG	22		
R50	21, 26	S18051BLACK	98, 113, 147	V5KF2530XXX	172		
R160	12, 21	S18052	170	V5KF2531XXX	172		
R325	12	S19432	177	V5KF2532XXX	172		
R330	12	S19433	177	V5KF2533XXX	172		
R538	34	S19442	177	V5KF5030XXX	172		
R540	34	S19443	177	V5KF5031XXX	172		
R541	34	S19683	197, 202, 206	V5KF5032XXX	172		
RA	193	S196810	194	V5KF5033XXX	172		
RA45B	158, 160	SB	33	V11	174		
RACABLE	193	SEK	151, 156, 159, 165	V12	174, 176, 177		
RAK	154, 159, 163			V13	173, 174, 177		
RAM1	188, 192			V14	176		
RAM1HA	192			V15	176, 187		
RAM1WMHA	192			V17	173, 177		
RAM2	188, 192			V18	176		
RAM2IR	192			V19	176		
RAM2IRHA	192			V19B	176		
RAM4	188, 192			V22	198, 200, 203, 207		
RAM4IR	192			V23	198, 200, 203, 207		
				V24	198, 200, 203, 207		

Subject Index

41 Series Airline Filter... 184-187
Replacement..... 187

88VX Series

Airline Respirators..... 125-138
Belt 133
Breathing Tube 133
Lenses 137-138
Maintenance Kit..... 136
Replacement..... 120-124
 131-138
Selection Chart..... 117, 127

Abrasive Blasting 114-115,
 125-126

ADP20 196
Replacement..... 196-198

Advent..... 7-8
Customization..... 13
Replacement..... 11-12

Air Driven Pump 196-198

Airflow Chart..... 56

Air Quality and Filtration 184-207

Aluminum Brackets..... 38

Batteries 62, 70

Belts 63, 71,
 147, 162,
 170

Blowers 62, 70

Brackets 37-38

Breathing Air

Supply Hose..... 171-176

Breathing Tubes 79, 81,
 145, 146,
 153, 170

Bump Caps..... 23-25
Decoration 30-34

CC20 Airline Respirator.. 83-99
Belt 95-98
Breathing Tube 94-95
Head Protection 92-93,
 143-144
Replacement Parts 91-99
Selection Chart..... 84

Chin Protector 36

Classic Series Hard Hat.. 14-16
Replacement..... 19-21

Clean Air Box 188-194

Color Selection Chart 28-29

Constant Flow

Respirator..... 85-87,
 109, 141

Credit..... 1

Decoration..... 28-34

Disposable Respirator 110

EDP10 199-200
Replacement..... 199-200

EDP16TE 201-203
Replacement..... 201-203

EDP30 204-207
Replacement..... 205-207

EDP50 204-207

Electric Driven Pumps 199-207

Emergency Response 7-8

EVA 58-62,
 66-70
Batteries..... 62, 70
Belt 63, 71
Blower..... 62, 70
Breathing Tubes 79
Filter..... 62, 70
Head Protection 77-78
Replacement..... 62, 70

***EVAHL**..... 66-71
Batteries..... 70
Belt 71
Blower..... 70
Breathing Tubes 79
Filter..... 70
Head Protection 77-78
Replacement..... 70-71

***Evaporative Cooling**..... 22, 43-44

Face Protection 35-42

FAMB..... 167-170
Breathing Tubes 170
Components 169
Fit Test Kit 170

Filters 62, 70

First Base Bump Cap 25

Free-Air Pumps..... 195-207
Hose 174

Freight 1

Full Body Dermal

Protection..... 106

Gang Charger..... 62, 70

***GenVX**..... 115-124
Belt 122
Breathing Tube 122
Lenses..... 124
Maintenance Kit..... 123
Replacement..... 122-124
Selection Chart..... 117

GR50 Airline Respirator . 139-147
Belt 145-146
Breathing Tube 145-146
Lenses..... 147
Replacement..... 142
Selection Chart..... 140

Grinding 114-136

Headgear 36

HEPA Filter Cartridges.... 157, 166

HEPA Protection 157, 166

High Heat Hard Hats 16

Hoses 171-177

Hot/Cold Tubes..... 178, 181

Hot Weather Accessories 22

Isotherm Cool Vest 44

Logos 27-34

Mylar Lens 76, 91,
 137, 147,
 156, 165

Nylon Brackets 37

Order..... 2

Organic Vapor

Protection..... 62, 64,
 70-71

PAPRs..... 56-94

PAPR Selection Chart 57

Paramedics..... 7-8

Personal Climate Devices 178-183

Quick-Disconnect

Couplers 176

Quick-Disconnect

Nipples..... 177

Remote Air Manifolds 192

Respirator Selection 49

RT Airline Respirator..... 107-113
Belts 113
Breathing Tubes 113
Replacement..... 112-113
Selection Chart..... 108

Sentinel..... 36

Spectrum Series

Respirator..... 148-150
Breathing Tubes 153
Continuous Flow..... 152-154,
 157
Pressure Demand..... 158-164,
 166

Standards

Head Protection 4
Face Protection 5-6
Respiratory..... 48-56

Standard Series

Hard Hat..... 17-18
Replacement..... 19-20

Striping 33-34

Supplied Air

Respirators 82-111

Terms 1

Turtle Club..... 45-46

V5 Coiled Hose..... 172

V10 3/8" ID Hose..... 173

V20 1/2" ID Hose..... 174

Vector..... 9-10
Customization..... 13
Replacement..... 11-12

Visors..... 39-42

*New products



Experience Build Your Bullard...



- The industry's first complete online product configurator
- Configure your Respiratory and Head Protection at www.BuildYourBullard.com

Easy. Complete. Personal.





www.bullard.com



Join our click.

www.bullard.com 

- Detailed Product Information
- Promotions and Giveaways
- Distributor Locator
- Shipment Tracking
- Hi-Res Photo Galleries
- Like Bullard on Facebook 
- View Our Product Videos on BullardTV 
- F.A.Q. - Frequently Asked Questions
- Downloads (Manuals, Brochures, etc.)
- Company and Product History
- Fully Searchable



Americas:

Bullard

1898 Safety Way

Cynthiana, KY 41031-9303 • USA

Toll-free within USA: 877-BULLARD (285-5273)

Tel: +1-859-234-6616 • Fax: +1-859-234-8987

Europe:

Bullard GmbH

Lilienthalstrasse 12

53424 Remagen • Germany

Tel: +49-2642 999980 • Fax : +49-2642 9999829

Asia-Pacific:

Bullard Asia Pacific Pte. Ltd.

LHK Building

701, Sims Drive, #04-03 • Singapore 387383

Tel: +65-6745-0556 • Fax: +65-6745-5176

©2013 Bullard. All rights reserved.

The Bullard 3-rib design is a trademark of E.D. Bullard Company.

GenVX is a trademark of Bullard

Bullard, Advent, Flex-Gear, Hard Boiled, Sure-Lock, Spectrum, Free-Air, Turtle Club, First Base and Isotherm are registered trademarks of Bullard.

Velcro is a registered trademark of Velcro USA.

Eastman and Tritan are trademarks of Eastman Chemical Company.

Scotchlite is a registered trademark of 3M Company.

Mylar and Tychem are registered trademarks of E. I. du Pont de Nemours and Company.

Polartec is a registered trademark of Polartec Fabrics.

Dynaswivel® is a registered trademark of DYNABRADE

Tyson® is a registered trademark of Saint-Gobain Performance Plastics

www.bullard.com