

Tools That Work



2018 Catalog

felo



NEW! from Bondhus

Stubby Double Ball End L-Wrenches



MaxTorque™ Ball End on short arm



Stubby Double Ball End L-Wrenches have the exclusive MaxTorque™ ball end on short arm that delivers 2x the torque of competitor ball ends, at up to a 15° angle.

p. 8

10 Piece Ball End L-Wrench Set

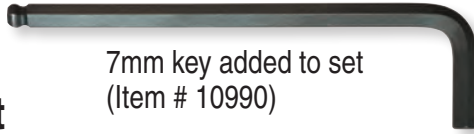

7mm key added to set (Item # 10990)

The NEW 10 piece Metric Ball End L-Wrench set includes the 7mm key (item #10990).

p. 11

Loop T-Handles



New Hex End Loop T-Handles available in Inch and Metric with 3", 6", and 9" lengths. Coated handles available in 6" and 9" lengths for user comfort.

p. 39-40



Torque Limiting Device (TLD)



Factory preset torque limits and interchangeable blades make ClickSet™ TLD the economical solution to an expensive problem. 1/4" Bit Holder now available.

p. 50-51



HandyHex™ Adjustable Handle

Hollow Hex handle allows adjustment of the distance a hex blade extends from the handle.

p. 56



ProHold® Hex End Power Bits

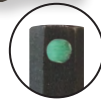

New ProHold® tipped hex bits hold fasteners securely to the tool head.

p. 58



ProHold® TORX® Power Bits



New ProHold® TORX® Power Bits hold TORX® and Star fasteners securely to the tool head.

p. 58

Lifetime Warranty

Bondhus manufactures the highest quality Hex and TORX® tools available, and every tool is backed by an unconditional lifetime warranty.

"All Bondhus products are guaranteed for life. If you are not satisfied with a Bondhus tool - for any reason - simply return it. A replacement will be shipped right out at no cost - no hassles, no questions asked."

A warranty is only as good as the company standing behind it. Bondhus has been the leading innovator in the Hex and TORX® tool industry for over fifty years.



Bondhus Professional Quality Tools Provide Superior Value

Time is money, and the real cost of using an inferior tool is realized when something goes wrong. As anyone who works with mechanical devices knows, bad things occasionally happen. It is not a question of “if”, but rather “when”.

Stripped screw heads are one of those bad things that happen. A screw with a stripped head can no longer be removed with a hex tool. If it is in a difficult to reach location, where a clamping device cannot grip it, the task becomes particularly problematic.

The cost of a high quality hex tool is negligible compared to the cost of removing a broken or stripped screw. Will the removal take a few hours? An entire day? What is the real cost of an inexpensive, poorly performing hex tool?

Bondhus quality hex tools are made from Protanium® high torque steel and have sharper corners to generate maximum holding and turning forces within the screw to virtually eliminate stripped screw heads.

Professional hex tools deliver a level of performance not attainable by consumer grade tools. In addition, safety is a factor that can impact the “actual” cost of ownership. As a result, knowledgeable buyers and professionals alike recognize the serious dangers of inferior tools that shatter instead of breaking clean.

The purpose of a high quality tool is to provide a faster, easier, and less costly means of performing a task. Bondhus strives to provide not just “good” tools, but the strongest tools available anywhere. Customer satisfaction is what we strive for.

Want to see more?
Scan the tag for
Bondhus tool videos:



Contents

ColorGuard™ L-Wrenches	5
	
L-Wrench Multi Packs	6-7
	
Stubby Double Ball End L-Wrenches	8-9
	
ProGuard™ L-Wrenches	10-18
	
Plated L-Wrenches	19-23
	
HexPro™ Pivot Head Wrenches	24-25
	
TORX® Tip L-Wrenches	26-28
	
Wing and Flag Tools	29
	
Fold Ups	30-33
	
T-Handles	34-41
	
Screwdrivers	42-48
	
Nut Drivers	49
	
ClickSet™ TLD	50-51
	
Socket Bits	52-55
	
HandyHex™ Handle, Blades	56-57
	
Bits, Hextenders, Screw Grab™	58-60
	

L-Wrenches



Color-Coded

- Inch
- Metric
- TORX®

- Available in a wide range of lengths and tip styles
- Chamfered tips for faster insertion and full tool engagement in the screw head
- Tools are made with custom heat treated Protanium® Steel for more torque and longer tool life
- Four finish options available

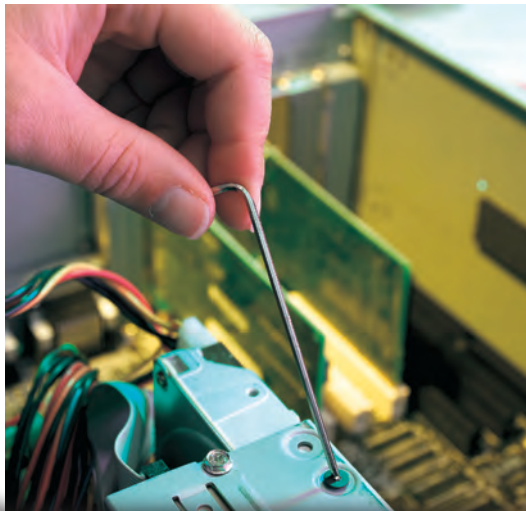

High Torque Steel:

Up to 20% stronger, with more torque and twice the wear resistance of standard grades of steel.

FINISH OPTIONS:



Corrosion-resistant finish:

Environmentally safe, provides better tool grip, resists solvents and is 5 times more corrosion resistant than competitor finishes.



Next generation chrome finish:

Traditional plated tool look with superior protection and durability.



Real 14 karat gold finish:

Superior protection and durability over traditional chrome and the look and shine of real gold.



Color-coded protective finish:

Durable color-coded finish for superior protection and easy tool identification.

More than just another L-Wrench

Bondhus is committed to making the best tools on the market. Bondhus is constantly working to improve our tools. We are never satisfied with "good enough." We work hard to make sure your new Bondhus L-Wrench is always the best tool for the job.

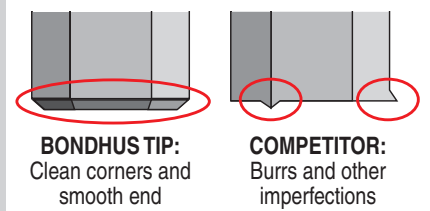

Bondhus chamfers every Hex and TORX® Tip tool we make. This process eliminates burrs and imperfections in the tool's tip that can prevent the tool from fitting properly or seating fully within the screw head.

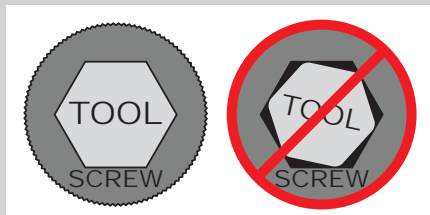

Every Bondhus tool is designed and machined to achieve an optimal fit between tool and fastener. Tools insert quickly and easily into screw head and fit snug to generate greater torque and minimize slippage and stripping.



Bondhus custom heat-treating produces tools that are highly resistant to breakage and shattering.

TORX® and TORX PLUS® are trademarks of Acument Intellectual Properties, LLC.

Ball End L-Wrenches - ColorGuard™ Finish -

- Color-coded tools can be distinguished at a glance
- Superior rust protection finish
- Sizes are stamped on the tool
- Ball End inserts into screw at a 25° angle
- Extra long length available

ColorGuard™ finish. Color-coded for easy identification.

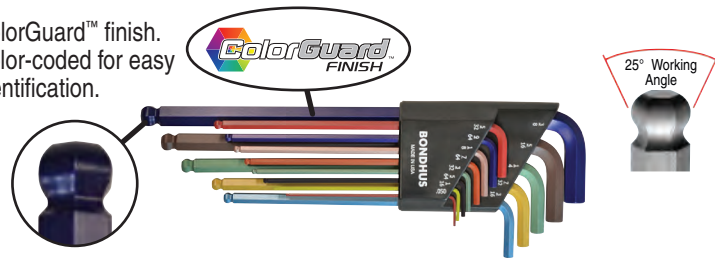

Sets	PART#	MODEL#	PCS	LENGTH	CONTENTS	QTY	LIST
Inch	69637	BLX13XLCG	13	Extra Long	.050, 1/16, 5/64, 3/32, 7/64, 1/8, 9/64, 5/32, 3/16, 7/32, 1/4, 5/16, 3/8"	1	\$37.55
Metric	69699	BLX9MXLCG	9	Extra Long	1.5, 2, 2.5, 3, 4, 5, 6, 8, 10mm	1	\$30.43
	69499	BLX9MCG	9	Long	1.5, 2, 2.5, 3, 4, 5, 6, 8, 10mm	1	\$27.01

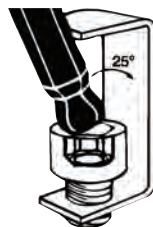
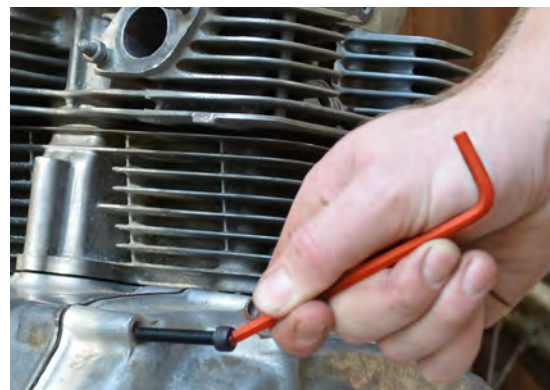

Multi Packs

L-Wrenches

- Assembled from our most popular sets
- Multiple sets per package
- Tip selections include Ball End, TORX®, Hex End, ProHold® Tip Ball End, and MaxTorque™ Ball End

Inch
Metric
TORX®

ProGuard™ Ball End



PART#	MODEL#	PCS	CONTENTS	QTY	LIST
20196	BLX21	21	10936 (.050-5/16") + 10999 (1.5-10mm)	1	\$29.03
20199	BLX22	22	10937 (.050-3/8") + 10999 (1.5-10mm)	1	\$32.91
20699	BLX22XL	22	16037 (.050-3/8") + 16099 (1.5-10mm)	1	\$40.00



20199

ProGuard™ Ball End Stubby



PART#	MODEL#	PCS	CONTENTS	QTY	LIST
20599	SBLX22	22	16537 (.050-3/8") + 16599 (1.5-10mm)	1	\$40.57
27098	SDBLX22XL	22	67037 (.050-3/8") + 67099 (1.5-10mm) STUBBY DOUBLE BALL END	1	\$53.44



20599

ProGuard™ ProHold® Tip Ball End



PART#	MODEL#	PCS	CONTENTS	QTY	LIST
20499	PBLX22	22	74937 (.050-3/8") + 74999 (1.5-10mm)	1	\$50.77



20499

ProGuard™ Hex End



PART#	MODEL#	PCS	CONTENTS	QTY	LIST
22199	HLX22	22	12137 (.050-3/8") + 12199 (1.5-10mm)	1	\$20.44
22138	HLX20	20	12138 (1/16-1/4" Long) + 12238 (1/16-1/4" Short)	1	\$11.65



22199

ProGuard™ Ball End and TORX® Tip

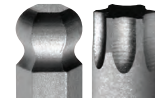

PART#	MODEL#	PCS	CONTENTS	QTY	LIST
14132	BLF30TS	30	10937 (.050-3/8") + 10999 (1.5-10mm) + 12632 (TORX® Fold Up T6-T25)	1	\$47.20
14138	BLF30T	30	10937 (.050-3/8") + 10999 (1.5-10mm) + 12634 (TORX® Fold Up T9-T40)	1	\$47.45
14126	BLF17S	17	10999 (1.5-10mm) + 12632 (TORX® Fold Up T6-T25)	1	\$28.77
14128	BLF17	17	10999 (1.5-10mm) + 12634 (TORX® Fold Up T9-T40)	1	\$29.08



14132

ProGuard™ Ball End and Hex End GorillaGrip® Fold Ups

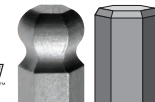

PART#	MODEL#	PCS	CONTENTS	QTY	LIST
14130	BLF34	34	10937 (.050-3/8") + 10999 (1.5-10mm) + 12550 (Hex Fold Up 5/64-5/32", 1.5-5mm)	1	\$43.11
14187	BLF16M	16	10999 (1.5-10mm) + 12587 (Hex Fold Up 2-8mm)	1	\$22.61
14189	BLF22	22	10937 (.050-3/8") + 12589 (Hex Fold Up 5/64-1/4")	1	\$25.25



14187

- Assembled from our most popular sets
- Multiple sets per package
- Tip selections include Ball End, TORX®, Hex End, ProHold® Tip Ball End, and MaxTorque™ Ball End



BriteGuard™ Ball End and ProGuard™ GorillaGrip® Fold Ups



PART#	MODEL#	PCS	CONTENTS	QTY	LIST
14170	BLF16MB	16	16999 (1.5-10mm) + 12587 (Hex Fold Up 2-8mm)	1	\$27.01



14170

ColorGuard™ Ball End



PART#	MODEL#	PCS	CONTENTS	QTY	LIST
69600	BLX22XLCG	22	69637 (.050-3/8") + 69699 (1.5-10mm)	1	\$64.55



69600

BriteGuard™ Ball End



PART#	MODEL#	PCS	CONTENTS	QTY	LIST
26999	BLX22B	22	16937 (.050-3/8") + 16999 (1.5-10mm)	1	\$44.23



26999

BriteGuard™ and GoldGuard™ Ball End



PART#	MODEL#	PCS	CONTENTS	QTY	LIST
20399	BLX22GB	22	26937 (.050-3/8") + 38099 (1.5-10mm)	1	\$48.96



20399

GoldGuard™ Ball End



PART#	MODEL#	PCS	CONTENTS	QTY	LIST
20899	BLX22G	22	37937 (.050-3/8") + 38099 (1.5-10mm)	1	\$47.17



20899

Stubby Double Ball End L-Wrenches



MaxTorque™ Ball End
15° angle

- Exclusive MaxTorque™ ball end on short arm allows access to screw heads located in tight spaces straight-in or at an angle
- Exclusive MaxTorque™ ball end delivers 50% more torque than conventional ball ends
- Exclusive MaxTorque™ ball end inserts into screw and works at a 15° angle
- Standard Bondhus ball end on long arm inserts into screw and works at a 25° angle
- Extra long length provides for greater torque

Color-Coded

- Inch
- Metric

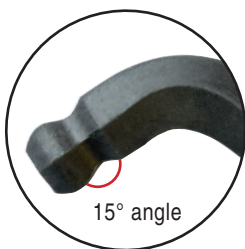

MaxTorque™ Ball End

Exclusive MaxTorque™ ball end on short arm delivers two times the torque of competitor ball ends, at up to a 15° angle

Standard Ball End
25° angle

Stubby Double Ball End L-Wrench compared to our standard Stubby L-Wrench

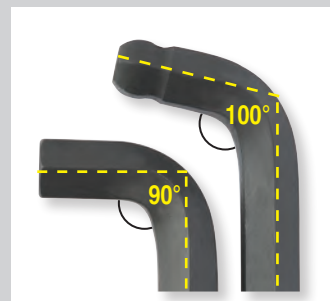

Exclusive MaxTorque™ ball end on short arm delivers two times the torque of competitor ball ends, at up to a 15° angle.

MaxTorque™ Ball End

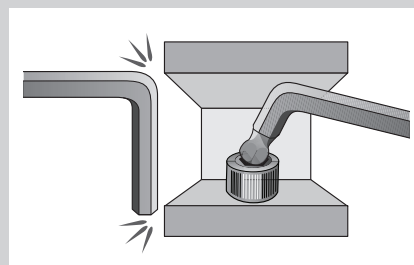

Stubby tools fit in tight spaces where there is not enough overhead clearance for a standard hex key.

Long Arm Ball End

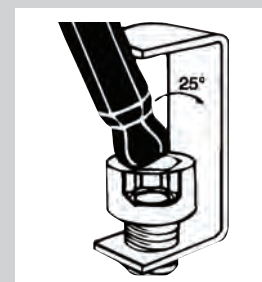

25° working angle on long arm allows tool to work in hard-to-reach places.

Stubby Double Ball End L-Wrenches

L-Wrenches

- Exclusive MaxTorque™ Ball End
 - on short arm allows access to screw heads located in tight spaces straight-in or at an angle
 - delivers 50% more torque than conventional ball ends
 - inserts into screw and works at a 15° angle
- Standard Bondhus ball end on long arm inserts into screw and works at a 25° angle
- Extra long length provides for greater torque



67099



Sets	PART#	MODEL#	PCS	LENGTH	CONTENTS	QTY	LIST
Inch	67037	SDBLX13XL	13	Extra Long	.050, 1/16, 5/64, 3/32, 7/64, 1/8, 9/64, 5/32, 3/16, 7/32, 1/4, 5/16, 3/8"	1	\$29.53
Metric	67099	SDBLX9MXL	9	Extra Long	1.5, 2, 2.5, 3, 4, 5, 6, 8, 10mm	1	\$23.91



77037



Sets	PART#	MODEL#	PCS	LENGTH	CONTENTS	QTY	LIST
Inch	77037	SDBLX13XL	13	Extra Long	.050, 1/16, 5/64, 3/32, 7/64, 1/8, 9/64, 5/32, 3/16, 7/32, 1/4, 5/16, 3/8"	1	\$39.30
Metric	77099	SDBLX9MXL	9	Extra Long	1.5, 2, 2.5, 3, 4, 5, 6, 8, 10mm	1	\$31.38



Singles	SIZE	INCH	MM	INCH	MM	PART#	QTY	LIST EA
LONG Inch	.050	3.1	79	0.25	6	67002	5	\$1.54
	1/16	3.3	84	0.24	6	67003	5	\$1.54
	5/64	3.6	91	0.32	8	67004	5	\$1.54
	3/32	3.9	98	0.36	9	67005	5	\$1.60
	7/64	4.1	104	0.36	9	67006	5	\$1.75
	1/8	4.4	113	0.37	9	67007	5	\$1.82
	9/64	4.8	121	0.37	9	67008	5	\$1.82
	5/32	5.1	130	0.38	10	67009	5	\$1.89
	3/16	5.3	134	0.44	11	67010	5	\$2.12
	7/32	5.7	144	0.48	12	67011	2	\$2.47
	1/4	6.5	164	0.49	12	67012	2	\$2.83
	5/16	7.1	180	0.61	15	67013	2	\$4.30
	3/8	7.8	199	0.84	21	67014	2	\$5.92
	LONG Metric	1.5	3.5	89	0.24	6	67050	5
2.0		3.9	100	0.32	8	67052	5	\$1.54
2.5		4.4	111	0.35	9	67054	5	\$1.60
3.0		4.9	125	0.37	9	67056	5	\$1.78
4.0		5.6	143	0.38	10	67060	5	\$1.90
5.0		6.4	161	0.43	11	67064	5	\$2.38
6		6.8	173	0.50	13	67068	5	\$2.94
8		7.7	194	0.60	15	67072	2	\$4.70
10		8.4	214	0.82	21	67076	2	\$6.80



Singles	SIZE	INCH	MM	INCH	MM	PART#	QTY	LIST EA
LONG Inch	.050	3.1	79	0.25	4	77002	5	\$2.05
	1/16	3.3	84	0.24	4	77003	5	\$2.05
	5/64	3.6	91	0.32	7	77004	5	\$2.05
	3/32	3.9	98	0.36	7	77005	5	\$2.09
	7/64	4.1	104	0.36	8	77006	5	\$2.36
	1/8	4.4	113	0.37	8	77007	5	\$2.42
	9/64	4.8	121	0.37	8	77008	5	\$2.42
	5/32	5.1	130	0.38	9	77009	5	\$2.48
	3/16	5.3	134	0.44	10	77010	5	\$2.81
	7/32	5.7	144	0.48	12	77011	2	\$3.29
	1/4	6.5	164	0.49	12	77012	2	\$3.81
	5/16	7.1	180	0.61	14	77013	2	\$5.80
	3/8	7.8	199	0.84	18	77014	2	\$8.09
	LONG Metric	1.5	3.5	89	0.24	6	77050	5
2.0		3.9	100	0.32	8	77052	5	\$2.00
2.5		4.4	111	0.35	9	77054	5	\$2.09
3.0		4.9	125	0.37	9	77056	5	\$2.35
4.0		5.6	143	0.38	10	77060	5	\$2.50
5.0		6.4	161	0.43	11	77064	5	\$3.10
6		6.8	173	0.50	13	77068	5	\$3.96
8		7.7	194	0.61	15	77072	2	\$6.32
10		8.4	214	0.82	21	77076	2	\$9.08

Ball End L-Wrenches - ProGuard™ Finish -

- Ball End inserts into a screw at a 25° angle
- Ball End saves time by quickly funneling tool into screw
- 25° angle allows natural hand and wrist movement
- Superior Ball End strength and working angle
- Works in hard to reach places

ProGuard™ finish delivers superior corrosion protection

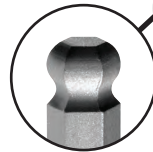

Ball End Tips

Yellow=Inch

Red=Metric



25° Working angle

Sets	PART#	MODEL#	PCS	LENGTH	CONTENTS	QTY	LIST
Inch	10945	BLX7	7	Long	5/64, 3/32, 7/64, 1/8, 9/64, 5/32, 3/16"	1	\$8.18
	10932	BLX8	8	Long	.050, 1/16, 5/64, 3/32, 7/64, 1/8, 9/64, 5/32"	1	\$8.69
	10938	BLX10	10	Long	1/16, 5/64, 3/32, 7/64, 1/8, 9/64, 5/32, 3/16, 7/32, 1/4"	1	\$12.06
	10936	BLX12	12	Long	.050, 1/16, 5/64, 3/32, 7/64, 1/8, 9/64, 5/32, 3/16, 7/32, 1/4, 5/16"	1	\$15.06
	10937	BLX13	13	Long	.050, 1/16, 5/64, 3/32, 7/64, 1/8, 9/64, 5/32, 3/16, 7/32, 1/4, 5/16, 3/8"	1	\$19.30
	10935	BLX15	15	Long	.050, 1/16, 5/64, 3/32, 7/64, 1/8, 9/64, 5/32, 3/16, 7/32, 1/4, 5/16, 3/8, 7/16, 1/2" (in vinyl roll up pouch)	1	\$47.30
	10933	MBLX13	13	Long	.050, 1/16, 5/64, 3/32, 7/64, 1/8, 9/64, 5/32, 3/16, 7/32, 1/4, 5/16, 3/8" (in metal box)	1	\$44.04
	16037	BLX13XL	13	Extra Long	.050, 1/16, 5/64, 3/32, 7/64, 1/8, 9/64, 5/32, 3/16, 7/32, 1/4, 5/16, 3/8"	1	\$23.29



10935



10933

Singles	SIZE	INCH		MM		PACKAGED			BULK			TAGGED/BARCODED		
		INCH	MM	INCH	MM	PART#	QTY	LIST EA	PART#	QTY	LIST EA	PART#	QTY	LIST EA
LONG Inch	.050	2.8	72	0.53	13	10902	10	\$1.00	12902	100	\$0.73	15702	10	\$1.09
	1/16	3.0	76	0.56	14	10903	10	\$1.00	12903	100	\$0.73	15703	10	\$1.09
	5/64	3.2	81	0.61	15	10904	10	\$1.00	12904	100	\$0.73	15704	10	\$1.09
	3/32	3.4	86	0.65	16	10905	10	\$1.05	12905	100	\$0.82	15705	10	\$1.13
	7/64	3.6	90	0.70	18	10906	10	\$1.17	12906	100	\$0.93	15706	10	\$1.27
	1/8	3.8	95	0.75	19	10907	10	\$1.22	12907	100	\$0.96	15707	10	\$1.31
	9/64	4.0	101	0.80	20	10908	10	\$1.22	12908	100	\$0.96	15708	10	\$1.31
	5/32	4.2	107	0.84	21	10909	10	\$1.27	12909	100	\$1.02	15709	10	\$1.38
	3/16	4.5	114	0.94	24	10910	10	\$1.48	12910	100	\$1.16	15710	10	\$1.59
	7/32	4.9	124	1.03	26	10911	5	\$1.78	12911	50	\$1.54	15711	5	\$1.91
	1/4	5.6	141	1.13	29	10912	5	\$2.05	12912	50	\$1.82	15712	5	\$2.21
	5/16	6.0	152	1.25	32	10913	5	\$3.23	12913	50	\$2.83	15713	5	\$3.51
	3/8	6.8	171	1.38	35	10914	5	\$4.54	12914	50	\$4.14	15714	5	\$4.91
	7/16	7.5	191	1.50	38	10915	1	\$9.41	12915	25	\$8.76	15715	1	\$10.14
	1/2	7.8	198	1.63	41	10916	1	\$12.06	12916	25	\$11.21	15716	1	\$12.98
	9/16	9.0	229	1.75	44	10917	1	\$14.75	12917	10	\$14.00	15717	1	\$15.88
	5/8	9.8	248	1.88	48	10918	1	\$16.48	12918	10	\$15.65	15718	1	\$17.75
	3/4	11.3	286	2.13	54	10919	1	\$27.25	12919	5	\$26.18	15719	1	\$29.34
	7/8	12.8	325	2.37	60	10920	1	\$61.54	-	-	-	-	-	-
	1	14.2	362	2.62	67	10921	1	\$82.10	-	-	-	-	-	-

Singles	SIZE	INCH		MM		PACKAGED		
		INCH	MM	PART#	QTY	LIST EA		
EXTRA LONG Inch	.050	3.1	77	0.53	13	16002	10	\$1.14
	1/16	3.3	85	0.56	14	16003	10	\$1.14
	5/64	3.6	92	0.61	15	16004	10	\$1.14
	3/32	3.9	99	0.65	16	16005	10	\$1.19
	7/64	4.1	105	0.70	18	16006	10	\$1.24
	1/8	4.5	114	0.75	19	16007	10	\$1.35
	9/64	4.8	122	0.80	20	16008	10	\$1.40
	5/32	5.1	131	0.84	21	16009	10	\$1.45
	3/16	5.2	132	0.94	24	16010	10	\$1.66
	7/32	5.6	143	1.03	26	16011	5	\$1.97
1/4	6.5	164	1.13	29	16012	5	\$2.48	
5/16	7.1	180	1.25	32	16013	5	\$3.88	
3/8	7.8	199	1.38	35	16014	5	\$5.69	

Did you know...?

Bondhus Ball End tips are designed to be the perfect balance between angle and strength. Ball End strength is maximized, while still providing a consistent full 25° working angle.

Ball End L-Wrenches - ProGuard™ Finish -

- Ball End inserts into a screw at a 25° angle
- Ball End saves time by quickly funneling tool into screw
- 25° angle allows natural hand and wrist movement
- Superior Ball End strength and working angle
- Works in hard to reach places



Sets	PART#	MODEL#	PCS	LENGTH	CONTENTS	QTY	LIST
Metric	10946	BLX6M	6	Long	1.5, 2, 2.5, 3, 4, 5mm	1	\$7.14
	10992	BLX7M	7	Long	1.5, 2, 2.5, 3, 4, 5, 6mm	1	\$9.52
	10999	BLX9M	9	Long	1.5, 2, 2.5, 3, 4, 5, 6, 8, 10mm	1	\$15.68
	10990	BLX10M	10	Long	NEW 1.5, 2, 2.5, 3, 4, 5, 6, 7, 8, 10mm (INCLUDES 7mm)	1	\$19.45
	10995	BLX15M	15	Long	1.27, 1.5, 2, 2.5, 3, 3.5, 4, 4.5, 5, 5.5, 6, 7, 8, 9, 10mm	1	\$26.34
	10989	MBLX13	13	Long	1.27, 1.5, 2, 2.5, 3, 4, 5, 6, 8, 10, 12, 14, 17mm (in metal box)	1	\$84.51
	16099	BLX9MXL	9	Extra Long	1.5, 2, 2.5, 3, 4, 5, 6, 8, 10mm	1	\$18.84



Singles	SIZE	INCH	MM	INCH	MM	SINGLE PACKAGING			BULK			TAGGED/BARCODED		
						PACKAGED	QTY	LIST EA	PART#	QTY	LIST EA	PART#	QTY	LIST EA
LONG Metric	1.27	2.8	72	0.53	13	10949	10	\$1.00	12949	100	\$0.73	15749	10	\$1.09
	1.5	3.0	77	0.53	14	10950	10	\$1.00	12950	100	\$0.73	15750	10	\$1.09
	2.0	3.2	82	0.61	16	10952	10	\$1.00	12952	100	\$0.73	15752	10	\$1.09
	2.5	3.5	88	0.69	17	10954	10	\$1.08	12954	100	\$0.82	15754	10	\$1.15
	3.0	3.9	98	0.75	19	10956	10	\$1.19	12956	100	\$0.96	15756	10	\$1.29
	3.5	3.9	100	0.85	21	10958	1	\$1.25	12958	100	\$1.02	15758	1	\$1.35
	4.0	4.3	110	0.87	22	10960	10	\$1.27	12960	100	\$1.02	15760	10	\$1.38
	4.5	4.5	114	1.00	25	10962	1	\$1.46	12962	100	\$1.27	15762	1	\$1.58
	5.0	4.7	119	1.06	27	10964	5	\$1.62	12964	100	\$1.27	15764	5	\$1.74
	5.5	4.9	124	1.14	29	10966	1	\$1.88	12966	50	\$1.60	15766	1	\$2.03
	6	5.5	139	1.22	31	10968	5	\$2.17	12968	50	\$1.95	15768	5	\$2.33
	7	5.5	140	1.30	33	10970	1	\$2.93	12970	50	\$2.67	15770	1	\$3.16
	8	6.0	152	1.38	35	10972	5	\$3.46	12972	50	\$3.04	15772	5	\$3.74
	9	6.2	159	1.46	37	10974	1	\$4.15	12974	50	\$3.74	15774	1	\$4.48
	10	6.7	171	1.54	39	10976	5	\$5.06	12976	50	\$4.63	15776	5	\$5.45
	11	7.9	200	1.63	42	10978	1	\$9.33	12978	25	\$8.65	15778	1	\$10.04
	12	8.7	220	1.73	44	10980	1	\$11.19	12980	25	\$10.39	15780	1	\$12.05
13	9.4	240	1.88	48	10982	1	\$13.98	12982	10	\$13.29	15782	1	\$15.07	
14	10.2	260	2.15	55	10984	1	\$13.98	12984	10	\$13.29	15784	1	\$15.07	
17	11.0	280	2.42	61	10986	1	\$22.18	12986	10	\$21.06	15786	1	\$23.87	
19	11.6	295	2.70	69	10988	1	\$26.30	12988	5	\$25.25	15788	1	\$28.33	
22	13.0	330	3.07	78	10991	1	\$64.79	-	-	-	-	-	-	
24	14.5	370	3.47	88	10993	1	\$82.10	-	-	-	-	-	-	

Singles	SIZE	INCH	MM	INCH	MM	SINGLE PACKAGING		
						PACKAGED	QTY	LIST EA
EXTRA LONG Metric	1.5	3.5	90	0.53	14	16050	10	\$1.14
	2.0	3.9	100	0.61	16	16052	10	\$1.14
	2.5	4.4	112	0.69	17	16054	10	\$1.24
	3.0	5.0	126	0.75	19	16056	10	\$1.35
	4.0	5.6	142	0.87	22	16060	10	\$1.50
	5.0	6.3	160	1.06	27	16064	5	\$1.86
	6	6.8	172	1.22	31	16068	5	\$2.54
8	7.7	195	1.38	35	16072	5	\$4.04	
10	8.4	213	1.54	39	16076	5	\$5.85	

Did you know...?

Bondhus' extremely precise manufacturing methods create Ball End tools that work very well, even in sizes as small as .050", 1.27mm, and T6 (BallStar™ Tip).

ProHold® Tip Ball End L-Wrenches

- ProGuard™ Finish -

- Holds screw tight on the tool EVERY TIME
- Button is non-magnetic
- Super smooth rotational action, with no interference from the ProHold® button
- Tool strength is not compromised by the ProHold® button

ProGuard™ finish delivers superior corrosion protection



Yellow=Inch
Red=Metric

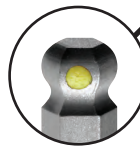

ProHold® Tip holds screws securely

Sets	PART#	MODEL#	PCS	LENGTH	CONTENTS	QTY	LIST
Inch	74938	PBLX10	10	Long	1/16, 5/64, 3/32, 7/64, 1/8, 9/64, 5/32, 3/16, 7/32, 1/4"	1	\$18.62
	74937	PBLX13	13	Long	.050, 1/16, 5/64, 3/32, 7/64, 1/8, 9/64, 5/32, 3/16, 7/32, 1/4, 5/16, 3/8"	1	\$29.81
Metric	74992	PBLX7M	7	Long	1.5, 2, 2.5, 3, 4, 5, 6mm	1	\$14.75
	74999	PBLX9M	9	Long	1.5, 2, 2.5, 3, 4, 5, 6, 8, 10mm	1	\$24.17



74999



Singles	SIZE	INCH		MM		PART#			PART#		
		INCH	MM	INCH	MM	QTY	LIST	EA	QTY	LIST	EA
LONG Inch	.050	2.8	72	0.53	13	75902	25	\$1.31	75702	5	\$1.61
	1/16	3.0	76	0.56	14	75903	25	\$1.31	75703	5	\$1.61
	5/64	3.2	81	0.61	15	75904	25	\$1.31	75704	5	\$1.61
	3/32	3.4	86	0.65	16	75905	25	\$1.43	75705	5	\$1.68
	7/64	3.6	90	0.70	18	75906	25	\$1.64	75706	5	\$1.90
	1/8	3.8	95	0.75	19	75907	25	\$1.69	75707	5	\$1.99
	9/64	4.0	101	0.80	20	75908	25	\$1.69	75708	5	\$1.99
	5/32	4.2	107	0.84	21	75909	25	\$1.76	75709	5	\$2.06
	3/16	4.5	114	0.94	24	75910	25	\$2.02	75710	5	\$2.40
	7/32	4.9	124	1.03	26	75911	10	\$2.58	75711	2	\$2.88
	1/4	5.6	141	1.13	29	75912	10	\$2.83	75712	2	\$3.15
	5/16	6.0	152	1.25	32	75913	10	\$3.82	75713	2	\$4.35
	3/8	6.8	171	1.38	35	75914	10	\$5.07	75714	2	\$5.68
LONG Metric	1.27	2.8	72	0.53	13	75949	25	\$1.31	75749	5	\$1.61
	1.5	3.0	77	0.53	14	75950	25	\$1.31	75750	5	\$1.61
	2.0	3.2	82	0.61	16	75952	25	\$1.31	75752	5	\$1.61
	2.5	3.5	88	0.69	17	75954	25	\$1.46	75754	5	\$1.72
	3.0	3.9	98	0.75	19	75956	25	\$1.67	75756	5	\$1.95
	4.0	4.3	110	0.87	22	75960	25	\$1.76	75760	5	\$2.06
	5.0	4.7	119	1.06	27	75964	25	\$2.23	75764	2	\$2.63
	6	5.5	139	1.22	31	75968	10	\$2.95	75768	2	\$3.26
	8	6.0	152	1.38	35	75972	10	\$4.02	75772	2	\$4.57
	10	6.7	171	1.54	39	75976	10	\$5.55	75776	2	\$6.19

Did you know...?
ProHold® buttons are non-magnetic and work on all fasteners. They are safe to use on sensitive equipment. They will not rust and will hold non-magnetic screws (aluminum, stainless and plastic).



ProHold® button holds screw tight on the tool EVERY TIME

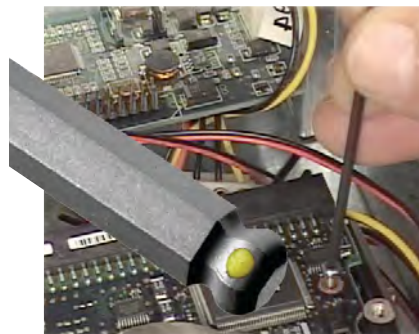

ProHold® buttons are non-magnetic and safe for use in electronic applications

Stubby Ball End L-Wrenches

- ProGuard™ Finish -

- Fits into tight spaces standard hex keys cannot
- Eliminates the need to trim and file the short arm
- Tighter inside radius means full smooth entry into screw head
- Chamfered short arm eliminates burrs
- Ball End inserts into a screw at a 25° angle



Sets	PART#	MODEL#	PCS	LENGTH	CONTENTS	QTY	LIST
Inch	16538	SBLX10	10	Long	1/16, 5/64, 3/32, 7/64, 1/8, 9/64, 5/32, 3/16, 7/32, 1/4"	1	\$14.80
	16537	SBLX13	13	Long	.050, 1/16, 5/64, 3/32, 7/64, 1/8, 9/64, 5/32, 3/16, 7/32, 1/4, 5/16, 3/8"	1	\$23.70
Metric	16592	SBLX7M	7	Long	1.5, 2, 2.5, 3, 4, 5, 6mm	1	\$11.70
	16599	SBLX9M	9	Long	1.5, 2, 2.5, 3, 4, 5, 6, 8, 10mm	1	\$19.25



Singles	SIZE	INCH	MM	INCH	MM	PART#	QTY	LIST EA	PART#	QTY	LIST EA
LONG Inch	.050	2.8	72	0.14	4	26502	50	\$1.16	16502	5	\$1.28
	1/16	3.0	76	0.16	4	26503	50	\$1.16	16503	5	\$1.28
	5/64	3.2	81	0.27	7	26504	50	\$1.16	16504	5	\$1.28
	3/32	3.4	86	0.29	7	26505	50	\$1.21	16505	5	\$1.35
	7/64	3.6	90	0.30	8	26506	50	\$1.38	16506	5	\$1.52
	1/8	3.8	95	0.32	8	26507	50	\$1.43	16507	5	\$1.58
	9/64	4.0	101	0.33	8	26508	50	\$1.43	16508	5	\$1.58
	5/32	4.2	107	0.35	9	26509	50	\$1.48	16509	5	\$1.64
	3/16	4.5	114	0.39	10	26510	50	\$1.68	16510	5	\$1.87
	7/32	4.9	124	0.46	12	26511	25	\$2.06	16511	2	\$2.28
	1/4	5.6	141	0.46	12	26512	25	\$2.37	16512	2	\$2.64
	5/16	6.0	152	0.57	14	26513	25	\$3.67	16513	2	\$4.10
	3/8	6.8	171	0.71	18	26514	25	\$5.15	16514	2	\$5.73
LONG Metric	1.27	2.8	72	0.14	4	26549	50	\$1.16	16549	5	\$1.28
	1.5	3.0	77	0.19	5	26550	50	\$1.16	16550	5	\$1.28
	2.0	3.2	82	0.27	7	26552	50	\$1.16	16552	5	\$1.28
	2.5	3.5	88	0.28	7	26554	50	\$1.21	16554	5	\$1.35
	3.0	3.9	98	0.32	8	26556	50	\$1.43	16556	5	\$1.58
	4.0	4.3	110	0.35	9	26560	50	\$1.48	16560	5	\$1.64
	5.0	4.7	119	0.40	10	26564	25	\$1.89	16564	2	\$2.10
	6	5.5	139	0.47	12	26568	25	\$2.47	16568	2	\$2.74
	8	6.0	152	0.57	14	26572	25	\$4.01	16572	2	\$4.44
	10	6.7	171	0.78	20	26576	25	\$5.90	16576	2	\$6.55

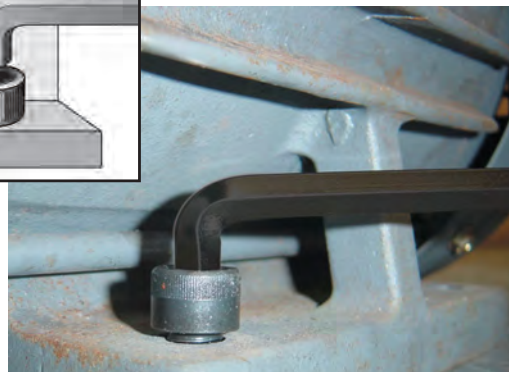
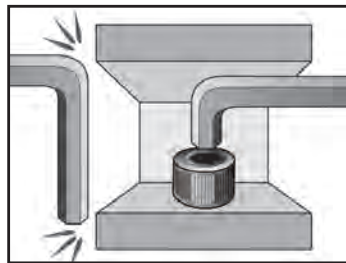

Stubby tools fit in tight spaces where there is not enough overhead clearance for a standard hex key

Hex End L-Wrenches

- ProGuard™ Finish -

- Chamfered tool tips eliminate burrs and help tools seat in screw head
- Sharp corners transfer more torque to the screw and reduce stripping
- Precision machined for ease of use and superior fit

ProGuard™ finish delivers superior corrosion protection



Sets	PART#	MODEL#	PCS	LENGTH	CONTENTS	QTY	LIST
Inch	12145	HLX7	7	Long	5/64, 3/32, 7/64, 1/8, 9/64, 5/32, 3/16"	1	\$4.40
	12132	HLX8	8	Long	.050, 1/16, 5/64, 3/32, 7/64, 1/8, 9/64, 5/32"	1	\$5.02
	12138	HLX10	10	Long	1/16, 5/64, 3/32, 7/64, 1/8, 9/64, 5/32, 3/16, 7/32, 1/4"	1	\$6.11
	12136	HLX12	12	Long	.050, 1/16, 5/64, 3/32, 7/64, 1/8, 9/64, 5/32, 3/16, 7/32, 1/4, 5/16"	1	\$8.80
	12137	HLX13	13	Long	.050, 1/16, 5/64, 3/32, 7/64, 1/8, 9/64, 5/32, 3/16, 7/32, 1/4, 5/16, 3/8"	1	\$11.07
	12245	HLX7S	7	Short	5/64, 3/32, 7/64, 1/8, 9/64, 5/32, 3/16"	1	\$4.04
	12232	HLX8S	8	Short	.050, 1/16, 5/64, 3/32, 7/64, 1/8, 9/64, 5/32"	1	\$4.40
	12238	HLX10S	10	Short	1/16, 5/64, 3/32, 7/64, 1/8, 9/64, 5/32, 3/16, 7/32, 1/4"	1	\$5.54
	12236	HLX12S	12	Short	.050, 1/16, 5/64, 3/32, 7/64, 1/8, 9/64, 5/32, 3/16, 7/32, 1/4, 5/16"	1	\$6.31
	12237	HLX13S	13	Short	.050, 1/16, 5/64, 3/32, 7/64, 1/8, 9/64, 5/32, 3/16, 7/32, 1/4, 5/16, 3/8"	1	\$7.61

In Metal Box

Sets	PART#	MODEL#	PCS	LENGTH	CONTENTS	QTY	LIST
Inch	12344	MHLX15S	15	Short	.028, .035, .050, 1/16, 5/64, 3/32, 7/64, 1/8, 9/64, 5/32, 3/16, 7/32, 1/4, 5/16, 3/8"	1	\$31.98
	12339	MHLX18S	18	Short	.028, .035, .050, 1/16, 5/64, 3/32, 7/64, 1/8, 9/64, 5/32, 3/16, 7/32, 1/4, 5/16, 3/8, 1/2, 9/16, 5/8"	1	\$44.66



In Plastic Box

Sets	PART#	MODEL#	PCS	LENGTH	CONTENTS	QTY	LIST
Inch	12342	MHLX13	13	Long	1/16, 5/64, 3/32, 7/64, 1/8, 9/64, 5/32, 3/16, 7/32, 1/4, 5/16, 3/8, 1/2"	1	\$19.30



In Pouch

Sets	PART#	MODEL#	PCS	LENGTH	CONTENTS	QTY	LIST
Inch	12335	PHLX9	9	Long	5/64, 3/32, 1/8, 5/32, 3/16, 7/32, 1/4, 5/16, 3/8"	1	\$8.23
	12333	PHLX11	11	Long	.050, 1/16, 5/64, 3/32, 1/8, 5/32, 3/16, 7/32, 1/4, 5/16, 3/8"	1	\$9.26
	12351	PHLX15	15	Long	5/64, 3/32, 7/64, 1/8, 9/64, 5/32, 3/16, 7/32, 1/4, 5/16, 3/8, 1/2, 9/16, 5/8, 3/4"	1	\$54.49
	12345	PHLX7S	7	Short	5/64, 3/32, 1/8, 5/32, 3/16, 7/32, 1/4"	1	\$4.92
	12338	PHLX10S	10	Short	.035, .050, 1/16, 5/64, 3/32, 1/8, 5/32, 3/16, 7/32, 1/4 "	1	\$5.95
	12341	PHLX11SS	11	Short	.050, 1/16, 5/64, 3/32, 1/8, 5/32, 3/16, 7/32, 1/4, 5/16, 3/8"	1	\$6.68
	12343	PHLX11S	11	Short	5/64, 3/32, 1/8, 5/32, 3/16, 7/32, 1/4, 5/16, 3/8, 1/2, 9/16"	1	\$16.51
	12347	PHLX15S	15	Short	.028, .035, .050, 1/16, 5/64, 3/32, 7/64, 1/8, 9/64, 5/32, 3/16, 7/32, 1/4, 5/16, 3/8"	1	\$7.97
	22789	PHLX9-6	9	6" Long Arm	5/64, 3/32, 1/8, 5/32, 3/16, 7/32, 1/4, 5/16, 3/8"	1	\$16.25
	25445	PHLX7-12	7	12" Long Arm	5/64, 3/32, 1/8, 5/32, 3/16, 7/32, 1/4"	1	\$22.51

12342



12347

SINGLE PACKAGING



SINGLE PACKAGING



Singles	SIZE	INCH	MM	INCH	MM	PART#	QTY	LIST EA
6" LONG ARM Inch	5/64	5.9	150	0.61	15	22704	5	\$0.96
	3/32	5.9	150	0.65	16	22705	5	\$0.96
	7/64	5.9	150	0.70	18	22706	5	\$0.96
	1/8	5.9	149	0.75	19	22707	5	\$0.98
	9/64	5.9	149	0.80	20	22708	5	\$1.04
	5/32	5.8	148	0.84	21	22709	5	\$1.04
	3/16	5.8	148	0.94	24	22710	5	\$1.13
	7/32	5.8	147	1.03	26	22711	5	\$1.18
	1/4	5.8	146	1.13	29	22712	5	\$1.28
	5/16	5.7	144	1.25	32	22713	5	\$1.73
	3/8	5.6	143	1.38	35	22714	5	\$2.55

Singles	SIZE	INCH	MM	INCH	MM	PART#	QTY	LIST EA
12" LONG ARM Inch	5/64	11.9	303	0.61	15	25404	5	\$2.92
	3/32	11.9	302	0.65	16	25405	5	\$3.03
	7/64	11.9	302	0.70	18	25406	5	\$3.08
	1/8	11.9	302	0.75	19	25407	5	\$3.08
	9/64	11.9	301	0.80	20	25408	5	\$3.14
	5/32	11.8	301	0.84	21	25409	5	\$3.14
	3/16	11.8	300	0.94	24	25410	5	\$3.35
	7/32	11.8	299	1.03	26	25411	5	\$3.41
1/4	11.8	298	1.13	29	25412	5	\$3.73	

For more individual sizes available packaged, in bulk, or singles see page 15

Hex End L-Wrench Singles

- ProGuard™ Finish -

- Chamfered tool tips eliminate burrs and help tools seat in screw head
- Sharp corners transfer more torque to the screw and reduce stripping
- Precision machined for ease of use and superior fit

ProGuard™ finish delivers superior corrosion protection

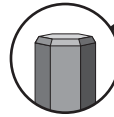

Hex End Tips



PACKAGED

SINGLE PACKAGING

BULK



TAGGED/BARCODED

Singles	SIZE	INCH	MM	INCH	MM	PART#	QTY	LIST EA	PART#	QTY	LIST EA	PART#	QTY	LIST EA	
LONG Inch	.028	2.6	66	0.22	6	12100	10	\$0.52	13900	100	\$0.32	15900	10	\$0.65	
	.035	2.7	68	0.34	9	12101	10	\$0.52	13901	100	\$0.32	15901	10	\$0.65	
	.050	2.8	72	0.53	13	12102	10	\$0.31	13902	100	\$0.17	15902	10	\$0.37	
	1/16	3.0	76	0.56	14	12103	10	\$0.35	13903	100	\$0.19	15903	10	\$0.40	
	5/64	3.2	81	0.61	15	12104	10	\$0.35	13904	100	\$0.19	15904	10	\$0.40	
	3/32	3.4	86	0.65	16	12105	10	\$0.35	13905	100	\$0.19	15905	10	\$0.40	
	7/64	3.6	90	0.70	18	12106	10	\$0.41	13906	100	\$0.27	15906	10	\$0.48	
	1/8	3.8	95	0.75	19	12107	10	\$0.43	13907	100	\$0.28	15907	10	\$0.50	
	9/64	4.0	101	0.80	20	12108	10	\$0.43	13908	100	\$0.28	15908	10	\$0.50	
	5/32	4.2	107	0.84	21	12109	10	\$0.48	13909	100	\$0.32	15909	10	\$0.57	
	3/16	4.5	114	0.94	24	12110	10	\$0.52	13910	100	\$0.38	15910	10	\$0.65	
	7/32	4.9	124	1.03	26	12111	5	\$0.77	13911	50	\$0.60	15911	5	\$0.92	
	1/4	5.3	133	1.13	29	12112	5	\$1.06	13912	50	\$0.83	15912	5	\$1.22	
	5/16	6.0	152	1.25	32	12113	5	\$1.59	13913	50	\$1.32	15913	5	\$1.89	
	3/8	6.8	171	1.38	35	12114	5	\$2.09	13914	50	\$1.97	15914	5	\$2.73	
	7/16	7.5	191	1.50	38	12115	1	\$4.83	13915	25	\$4.26	15915	1	\$5.76	
	1/2	7.8	198	1.63	41	12116	1	\$5.48	13916	25	\$4.80	15916	1	\$6.52	
	9/16	9.0	229	1.75	44	12117	1	\$7.16	13917	10	\$6.21	15917	1	\$8.52	
	5/8	9.8	248	1.88	48	12118	1	\$11.26	13918	10	\$10.14	15918	1	\$13.39	
	3/4	11.3	286	2.13	54	12119	1	\$16.36	13919	5	\$14.90	15919	1	\$19.49	
	7/8	12.7	322	2.37	60	12120	1	\$27.71	-	-	-	-	-	-	-
	1	14.1	359	2.62	67	12121	1	\$37.95	-	-	-	-	-	-	-
	1 1/4	17.0	432	3.00	76	12125	1	\$150.89	-	-	-	-	-	-	-
	1 1/2	20.3	514	3.50	89	12129	1	\$240.97	-	-	-	-	-	-	-



PACKAGED

SINGLE PACKAGING

BULK



TAGGED/BARCODED

Singles	SIZE	INCH	MM	INCH	MM	PART#	QTY	LIST EA	PART#	QTY	LIST EA	PART#	QTY	LIST EA	
SHORT Inch	.028	1.2	31	0.22	6	12200	10	\$0.37	13800	100	\$0.23	15800	10	\$0.43	
	.035	1.2	31	0.34	9	12201	10	\$0.37	13801	100	\$0.23	15801	10	\$0.43	
	.050	1.6	42	0.53	13	12202	10	\$0.27	13802	100	\$0.13	15802	10	\$0.31	
	1/16	1.8	45	0.56	14	12203	10	\$0.27	13803	100	\$0.13	15803	10	\$0.31	
	5/64	1.9	48	0.61	15	12204	10	\$0.29	13804	100	\$0.16	15804	10	\$0.35	
	3/32	2.0	51	0.65	16	12205	10	\$0.29	13805	100	\$0.16	15805	10	\$0.35	
	7/64	2.1	54	0.70	18	12206	10	\$0.31	13806	100	\$0.17	15806	10	\$0.37	
	1/8	2.3	58	0.75	19	12207	10	\$0.31	13807	100	\$0.17	15807	10	\$0.37	
	9/64	2.4	61	0.80	20	12208	10	\$0.34	13808	100	\$0.19	15808	10	\$0.40	
	5/32	2.5	64	0.84	21	12209	10	\$0.34	13809	100	\$0.19	15809	10	\$0.40	
	3/16	2.8	70	0.94	24	12210	10	\$0.41	13810	100	\$0.27	15810	10	\$0.48	
	7/32	3.0	77	1.03	26	12211	5	\$0.54	13811	50	\$0.39	15811	5	\$0.67	
	1/4	3.3	83	1.13	29	12212	5	\$0.66	13812	50	\$0.48	15812	5	\$0.77	
	5/16	3.8	96	1.25	32	12213	5	\$0.98	13813	50	\$0.79	15813	5	\$1.18	
	3/8	4.3	108	1.38	35	12214	5	\$1.45	13814	50	\$1.19	15814	5	\$1.72	
	7/16	4.8	121	1.50	38	12215	1	\$3.39	13815	50	\$2.78	15815	1	\$4.04	
	1/2	5.3	133	1.63	41	12216	1	\$4.01	13816	50	\$3.27	15816	1	\$4.76	
	9/16	5.8	146	1.75	44	12217	1	\$5.50	13817	25	\$4.62	15817	1	\$6.53	
	5/8	6.3	159	1.88	48	12218	1	\$7.13	13818	20	\$6.07	15818	1	\$8.49	
	3/4	7.3	184	2.13	54	12219	1	\$11.34	13819	15	\$9.76	15819	1	\$13.52	
	7/8	8.2	207	2.37	60	12220	1	\$18.07	-	-	-	-	-	-	-
	1	9.2	232	2.62	67	12221	1	\$26.50	-	-	-	-	-	-	-
	1 1/4	11.0	279	3.00	76	12225	1	\$75.92	-	-	-	-	-	-	-
	1 1/2	13.0	330	3.50	89	12229	1	\$94.86	-	-	-	-	-	-	-
	1 3/4	13.3	337	4.00	102	12231	1	\$181.28	-	-	-	-	-	-	-
	2	15.0	381	4.50	114	12233	1	\$243.38	-	-	-	-	-	-	-

For sets and 6" and 12" Long Arm singles see page 14

Hex End L-Wrenches

- ProGuard™ Finish -

- Chamfered tool tips eliminate burrs and help tools seat in screw head
- Sharp corners transfer more torque to the screw and reduce stripping
- Precision machined for ease of use and superior fit



Sets	PART#	MODEL#	PCS	LENGTH	CONTENTS	QTY	LIST
Metric	12146	HLX6M	6	Long	1.5, 2, 2.5, 3, 4, 5mm	1	\$5.28
	12192	HLX7M	7	Long	1.5, 2, 2.5, 3, 4, 5, 6mm	1	\$6.62
	12199	HLX9M	9	Long	1.5, 2, 2.5, 3, 4, 5, 6, 8, 10mm	1	\$10.51
	12195	HLX15M	15	Long	1.27, 1.5, 2, 2.5, 3, 3.5, 4, 4.5, 5, 5.5, 6, 7, 8, 9, 10mm	1	\$17.70
	12246	HLX6MS	6	Short	1.5, 2, 2.5, 3, 4, 5mm	1	\$4.66
	12292	HLX7MS	7	Short	1.5, 2, 2.5, 3, 4, 5, 6mm	1	\$5.49
	12299	HLX9MS	9	Short	1.5, 2, 2.5, 3, 4, 5, 6, 8, 10mm	1	\$8.38

In Metal Box

Sets	PART#	MODEL#	PCS	LENGTH	CONTENTS	QTY	LIST
Metric	12396	MHLX10M	10	Long	1.5, 2, 2.5, 3, 4, 5, 6, 8, 10, 12mm	1	\$34.57
	12393	MHLX12MS	12	Short	.71, .89, 1.27, 1.5, 2, 2.5, 3, 4, 5, 6, 8, 10mm	1	\$26.55
	12394	MHLX15MS	15	Short	.71, .89, 1.27, 1.5, 2, 2.5, 3, 4, 5, 6, 8, 10, 12, 14, 17mm	1	\$44.61



12394

In Pouch

Sets	PART#	MODEL#	PCS	LENGTH	CONTENTS	QTY	LIST
Metric	12349	PHLX15M	15	Long	.89, 1.27, 1.5, 2, 2.5, 3, 4, 5, 6, 8, 10, 12, 14, 17, 19mm	1	\$63.24
	12392	PHLX7MS	7	Short	2, 2.5, 3, 4, 5, 6, 8mm	1	\$5.59
	12399	PHLX9MS	9	Short	1.5, 2, 2.5, 3, 4, 5, 6, 8, 10mm	1	\$8.44
	12391	PHLX11MS	11	Short	2, 2.5, 3, 4, 5, 6, 7, 8, 9, 10, 12mm	1	\$18.79
	12397	PHLX14MS	14	Short	2, 2.5, 3, 4, 5, 6, 7, 8, 9, 10, 12, 14, 17, 19mm	1	\$37.88



12397

Did you know...?

Bondhus tools are harder and more ductile than competitors' tools. They wear longer, generate greater torque and resist breakage and shattering.

For individual sizes available packaged, in bulk, or singles see page 17

Hex End L-Wrench Singles

- ProGuard™ Finish -

ProGuard™ finish delivers superior corrosion protection



L-Wrenches

- Chamfered tool tips eliminate burrs and help tools seat in screw head
- Sharp corners transfer more torque to the screw and reduce stripping
- Precision machined for ease of use and superior fit

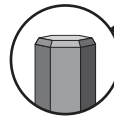

Hex End Tips

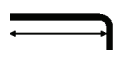

SINGLE PACKAGING
PACKAGED

BULK



TAGGED/BARCODED

Singles	SIZE	INCH	MM	INCH	MM	PART#	QTY	LIST EA	PART#	QTY	LIST EA	PART#	QTY	LIST EA	
LONG Metric	0.71	2.6	66	0.22	6	12147	10	\$0.52	13947	100	\$0.32	15947	10	\$0.65	
	0.89	2.7	68	0.34	9	12148	10	\$0.52	13948	100	\$0.32	15948	10	\$0.65	
	1.27	2.8	72	0.53	13	12149	10	\$0.31	13949	100	\$0.17	15949	10	\$0.37	
	1.5	3.0	77	0.53	14	12150	10	\$0.35	13950	100	\$0.19	15950	10	\$0.40	
	2.0	3.2	82	0.61	16	12152	10	\$0.35	13952	100	\$0.19	15952	10	\$0.40	
	2.5	3.5	88	0.69	17	12154	10	\$0.41	13954	100	\$0.27	15954	10	\$0.48	
	3.0	3.9	98	0.75	19	12156	10	\$0.41	13956	100	\$0.27	15956	10	\$0.48	
	3.5	3.9	100	0.85	21	12158	1	\$0.48	13958	100	\$0.32	15958	1	\$0.57	
	4.0	4.3	110	0.87	22	12160	10	\$0.48	13960	100	\$0.32	15960	10	\$0.57	
	4.5	4.5	114	1.00	25	12162	1	\$0.72	13962	100	\$0.50	15962	1	\$0.87	
	5.0	4.7	119	1.06	27	12164	5	\$0.72	13964	100	\$0.50	15964	5	\$0.87	
	5.5	4.9	124	1.14	29	12166	1	\$1.04	13966	50	\$0.83	15966	1	\$1.22	
	6	5.5	139	1.22	31	12168	5	\$1.04	13968	50	\$0.83	15968	5	\$1.22	
	7	5.5	140	1.30	33	12170	1	\$1.68	13970	50	\$1.45	15970	1	\$2.01	
	8	6.0	152	1.38	35	12172	5	\$1.68	13972	50	\$1.45	15972	5	\$2.01	
	9	6.2	159	1.46	37	12174	1	\$2.66	13974	50	\$2.28	15974	1	\$3.16	
	10	6.7	171	1.54	39	12176	5	\$2.66	13976	50	\$2.28	15976	5	\$3.16	
	11	7.9	200	1.63	42	12178	1	\$5.71	13978	25	\$5.09	15978	1	\$6.79	
	12	8.7	220	1.73	44	12180	1	\$5.71	13980	25	\$5.09	15980	1	\$6.79	
	13	9.4	240	1.88	48	12182	1	\$7.59	13982	10	\$6.93	15982	1	\$9.04	
	14	10.2	260	2.15	55	12184	1	\$7.59	13984	10	\$6.93	15984	1	\$9.04	
	17	11.0	280	2.42	61	12186	1	\$10.85	13986	10	\$9.83	15986	1	\$12.91	
	19	11.6	295	2.70	69	12188	1	\$15.07	13988	5	\$13.87	15988	1	\$17.93	
	22	12.8	325	3.07	78	12191	1	\$28.32	-	-	-	-	-	-	-
	24	14.3	364	3.47	88	12193	1	\$39.74	-	-	-	-	-	-	-
	32	17.0	432	4.80	122	12196	1	\$155.25	-	-	-	-	-	-	-
	36	20.3	516	5.37	137	12198	1	\$253.06	-	-	-	-	-	-	-

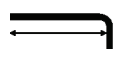

SINGLE PACKAGING
PACKAGED

BULK



TAGGED/BARCODED

Singles	SIZE	INCH	MM	INCH	MM	PART#	QTY	LIST EA	PART#	QTY	LIST EA	PART#	QTY	LIST EA	
SHORT Metric	0.71	1.2	31	0.22	6	12247	10	\$0.37	13847	100	\$0.23	15847	10	\$0.43	
	0.89	1.2	31	0.34	9	12248	10	\$0.37	13848	100	\$0.23	15848	10	\$0.43	
	1.27	1.6	42	0.53	13	12249	10	\$0.27	13849	100	\$0.13	15849	10	\$0.31	
	1.5	1.7	44	0.53	14	12250	10	\$0.27	13850	100	\$0.13	15850	10	\$0.31	
	2.0	1.9	49	0.61	16	12252	10	\$0.29	13852	100	\$0.16	15852	10	\$0.35	
	2.5	2.1	54	0.69	17	12254	10	\$0.29	13854	100	\$0.16	15854	10	\$0.35	
	3.0	2.4	61	0.75	19	12256	10	\$0.31	13856	100	\$0.17	15856	10	\$0.37	
	3.5	2.6	65	0.85	21	12258	1	\$0.34	13858	100	\$0.19	15858	1	\$0.40	
	4.0	2.7	68	0.87	22	12260	10	\$0.34	13860	100	\$0.19	15860	10	\$0.40	
	4.5	2.9	73	1.00	25	12262	1	\$0.41	13862	100	\$0.32	15862	1	\$0.48	
	5.0	3.1	78	1.06	27	12264	5	\$0.41	13864	100	\$0.32	15864	5	\$0.48	
	5.5	3.3	83	1.14	29	12266	1	\$0.66	13866	50	\$0.48	15866	1	\$0.77	
	6	3.5	88	1.22	31	12268	5	\$0.66	13868	50	\$0.48	15868	5	\$0.77	
	7	3.7	93	1.30	33	12270	1	\$1.04	13870	50	\$0.83	15870	1	\$1.20	
	8	3.9	98	1.38	35	12272	5	\$1.04	13872	50	\$0.83	15872	5	\$1.20	
	9	4.0	102	1.46	37	12274	1	\$1.68	13874	50	\$1.45	15874	1	\$2.01	
	10	4.3	109	1.54	39	12276	5	\$1.68	13876	50	\$1.45	15876	5	\$2.01	
	11	4.5	115	1.63	42	12278	1	\$4.30	13878	50	\$3.67	15878	1	\$5.09	
	12	4.8	122	1.73	44	12280	1	\$4.30	13880	50	\$3.67	15880	1	\$5.09	
	13	5.1	129	1.88	48	12282	1	\$5.88	13882	25	\$2.02	15882	1	\$6.99	
	14	5.4	136	2.15	55	12284	1	\$5.88	13884	25	\$5.06	15884	1	\$6.99	
	17	6.1	156	2.42	61	12286	1	\$6.39	13886	20	\$5.61	15886	1	\$7.59	
	19	6.9	175	2.72	69	12288	1	\$10.85	13888	15	\$9.54	15888	1	\$12.90	
	22	7.5	190	3.07	78	12291	1	\$25.30	-	-	-	-	-	-	-
	24	8.4	213	3.47	88	12293	1	\$31.64	-	-	-	-	-	-	-
	27	9.4	238	3.84	98	12295	1	\$63.29	-	-	-	-	-	-	-
	32	11.8	300	4.80	122	12296	1	\$75.92	-	-	-	-	-	-	-
	36	13.3	338	5.37	137	12298	1	\$94.86	-	-	-	-	-	-	-

For sets see page 16

Made in the U.S.A.



All Bondhus® tools are made with Protanium® High Torque Steel.

Tamper Resistant Hex End L-Wrenches

- ProGuard™ Finish -

- Fits all tamper resistant hex screws
- Chamfered tool tips eliminate burrs and help tools seat in screw head
- Sharp corners transfer more torque to the screw and reduce stripping
- Precision machined for ease of use and superior fit

ProGuard™ finish delivers superior corrosion protection



Tamper Resistant Hex Tips

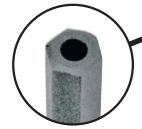

Tamper Resistant Hex Tips

Sets	PART#	MODEL#	PCS	LENGTH	CONTENTS	QTY	LIST
Inch	48332	HTR8	8	Long	3/32, 1/8, 5/32, 3/16, 7/32, 1/4, 5/16, 3/8"	1	\$34.05
Metric	48386	HTR6M	6	Long	2.5, 3, 4, 5, 6, 8mm	1	\$24.53



Singles	SIZE	INCH	MM	INCH	MM	PART#	QTY	LIST EA
LONG Inch	3/32	3.4	86	0.65	16	48305	5	\$3.84
	1/8	3.8	95	0.75	19	48307	5	\$3.89
	5/32	4.2	107	0.84	21	48309	5	\$4.00
	3/16	4.5	114	0.94	24	48310	5	\$4.06
	7/32	4.9	124	1.03	26	48311	5	\$4.16
	1/4	5.3	133	1.13	29	48312	5	\$4.33
	5/16	6.0	152	1.25	32	48313	5	\$4.38
	3/8	6.8	171	1.38	35	48314	2	\$5.36
LONG Metric	2.5	3.5	88	0.69	17	48354	5	\$3.84
	3.0	3.9	98	0.75	19	48356	5	\$3.89
	4.0	4.3	110	0.87	22	48360	5	\$4.00
	5.0	4.7	119	1.06	27	48364	5	\$4.06
	6	5.5	139	1.22	31	48368	5	\$4.33
	8	6.0	152	1.38	35	48372	5	\$4.38
	10	6.7	171	1.54	39	48376	2	\$5.36



48332

Tamper Resistant TORX® L-Wrenches

- ProGuard™ Finish -

- Fits all TORX® and Star tamper resistant screws
- Burr free tool tips help tools seat fully in screw head
- Precision machined tips transfer more torque to the screw and reduces stripping

ProGuard™ finish delivers superior corrosion protection



Tools are in color coded cases for easy recognition

Green=TORX®

Tamper Resistant TORX® Tips

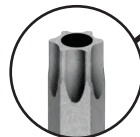

Tamper Resistant TORX® Tips

Sets	PART#	MODEL#	PCS	LENGTH	CONTENTS	QTY	LIST
TORX®	32432	TR-TL8S	8	Long	TR6, TR7, TR8, TR9, TR10, TR15, TR20, TR25	1	\$29.24
	32434	TR-TL8	8	Long	TR9, TR10, TR15, TR20, TR25, TR27, TR30, TR40	1	\$25.00



Singles	SIZE	INCH	MM	INCH	MM	PART#	QTY	LIST EA	PART#	QTY	LIST EA
LONG TORX®	TR6	2.1	55	0.65	16	33406	25	\$4.55	32406	2	\$5.07
	TR7	2.4	61	0.65	16	33407	25	\$4.22	32407	2	\$4.68
	TR8	2.6	67	0.65	16	33408	25	\$4.22	32408	2	\$4.68
	TR9	2.9	74	0.65	16	33409	25	\$4.22	32409	2	\$4.68
	TR10	3.2	80	0.73	19	33410	25	\$2.23	32410	2	\$2.58
	TR15	3.3	84	0.78	20	33415	25	\$2.28	32415	2	\$2.69
	TR20	3.6	91	0.78	20	33420	25	\$2.40	32420	2	\$2.80
	TR25	3.8	98	0.88	22	33425	25	\$2.51	32425	2	\$2.93
	TR27	4.2	106	0.95	24	33427	25	\$2.75	32427	2	\$3.04
	TR30	4.6	116	1.03	26	33430	25	\$2.79	32430	2	\$3.34
	TR40	4.9	125	1.11	28	33440	25	\$2.93	32440	2	\$3.45

Did you know...?

ProGuard™ Dry Surface Technology is the world's best corrosion protection. The tool user does not have to work with rusty tools. ProGuard™ protection delivers up to 5 times the corrosion resistance of any other Hex or TORX® tool finish.

TORX® and TORX PLUS® are registered trademarks of Acument Intellectual Properties, LLC.

Ball End L-Wrenches

- BriteGuard™ Finish -

- Ball End inserts into a screw at a 25° angle
- Ball End saves time by quickly funneling tool into screw
- 25° angle allows natural hand and wrist movement
- Superior Ball End strength and working angle
- Works in hard to reach places

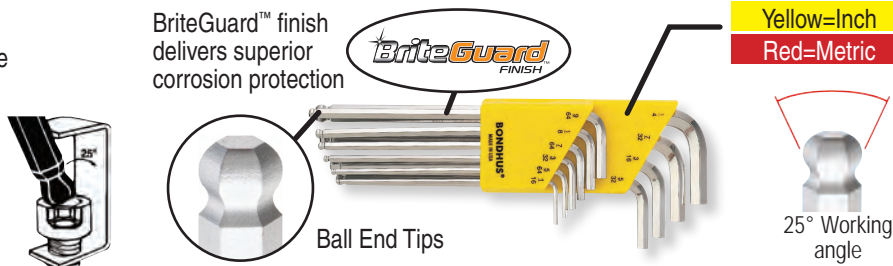

Sets	PART#	MODEL#	PCS	LENGTH	CONTENTS	QTY	LIST
Inch	16938	BLX10B	10	Long	1/16, 5/64, 3/32, 7/64, 1/8, 9/64, 5/32, 3/16, 7/32, 1/4"	1	\$16.79
	16936	BLX12B	12	Long	.050, 1/16, 5/64, 3/32, 7/64, 1/8, 9/64, 5/32, 3/16, 7/32, 1/4, 5/16"	1	\$20.98
	16937	BLX13B	13	Long	.050, 1/16, 5/64, 3/32, 7/64, 1/8, 9/64, 5/32, 3/16, 7/32, 1/4, 5/16, 3/8"	1	\$26.90
Metric	17046	BLX6MB	6	Extra Long	1.5, 2, 2.5, 3, 4, 5mm	1	\$9.89
	17092	BLX7MB	7	Extra Long	1.5, 2, 2.5, 3, 4, 5, 6mm	1	\$13.31
	17099	BLX9MB	9	Extra Long	1.5, 2, 2.5, 3, 4, 5, 6, 8, 10mm	1	\$21.84
	17095	BLX15MB	15	Extra Long	1.27, 1.5, 2, 2.5, 3, 3.5, 4, 4.5, 5, 5.5, 6, 7, 8, 9, 10mm	1	\$36.57
	16999	BLX9MLB	9	Long	1.5, 2, 2.5, 3, 4, 5, 6, 8, 10mm	1	\$19.67



Singles	SIZE	INCH	MM	INCH	MM	PART#	QTY	LIST EA	PART#	QTY	LIST EA
LONG Inch	.050	2.8	72	0.53	13	26902	50	\$1.07	16902	10	\$1.38
	1/16	3.0	76	0.56	14	26903	50	\$1.07	16903	10	\$1.38
	5/64	3.2	81	0.61	15	26904	50	\$1.07	16904	10	\$1.38
	3/32	3.4	86	0.65	16	26905	50	\$1.25	16905	10	\$1.44
	7/64	3.6	90	0.70	18	26906	50	\$1.38	16906	10	\$1.65
	1/8	3.8	95	0.75	19	26907	50	\$1.51	16907	10	\$1.70
	9/64	4.0	101	0.80	20	26908	50	\$1.51	16908	10	\$1.70
	5/32	4.2	107	0.84	21	26909	50	\$1.58	16909	10	\$1.77
	3/16	4.5	114	0.94	24	26910	50	\$1.77	16910	10	\$2.05
	7/32	4.9	124	1.03	26	26911	25	\$2.28	16911	5	\$2.45
	1/4	5.6	141	1.13	29	26912	25	\$2.69	16912	5	\$2.81
	5/16	6.0	152	1.25	32	26913	25	\$4.27	16913	5	\$4.46
	3/8	6.8	171	1.38	35	26914	25	\$5.97	16914	5	\$6.29
	7/16	7.5	191	1.50	38	-	-	-	16915	1	\$11.55
	1/2	7.8	198	1.63	41	-	-	-	16916	1	\$14.45
	9/16	9.0	229	1.75	44	-	-	-	16917	1	\$18.39
5/8	9.8	248	1.88	48	-	-	-	16918	1	\$21.01	
3/4	11.3	286	2.13	54	-	-	-	16919	1	\$31.52	

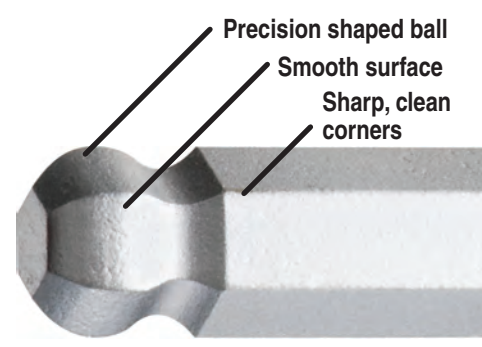

EXTRA LONG Metric	1.27	2.8	72	0.53	13	27049	50	\$1.07	17049	10	\$1.38
	1.5	3.5	90	0.53	14	27050	50	\$1.07	17050	10	\$1.38
	2.0	3.9	100	0.61	16	27052	50	\$1.07	17052	10	\$1.38
	2.5	4.4	112	0.69	17	27054	50	\$1.25	17054	10	\$1.44
	3.0	5.0	126	0.75	19	27056	50	\$1.38	17056	10	\$1.65
	3.5	5.2	133	0.85	21	27058	50	\$1.58	17058	1	\$1.77
	4.0	5.6	142	0.87	22	27060	50	\$1.58	17060	10	\$1.77
	4.5	5.9	151	1.00	25	27062	50	\$1.77	17062	1	\$2.05
	5.0	6.3	160	1.06	27	27064	50	\$1.97	17064	5	\$2.23
	5.5	6.8	172	1.14	29	27066	25	\$2.50	17066	1	\$2.63
	6	6.8	172	1.22	31	27068	25	\$2.75	17068	5	\$2.96
	7	7.2	184	1.30	33	27070	25	\$3.80	17070	1	\$4.00
	8	7.7	195	1.38	35	27072	25	\$4.54	17072	5	\$4.79
	9	8.0	202	1.46	37	27074	25	\$5.59	17074	1	\$5.70
	10	8.4	213	1.54	39	27076	10	\$6.85	17076	5	\$6.95
	11	7.9	200	1.63	42	27078	10	\$11.30	17078	1	\$11.55
12	8.7	220	1.73	44	27080	10	\$11.30	17080	1	\$11.55	
14	10.2	260	2.15	55	-	-	-	17084	1	\$16.42	
17	11.0	280	2.42	61	-	-	-	17086	1	\$24.96	
19	11.6	295	2.70	69	-	-	-	17088	1	\$31.52	

Did you know...?

Bondhus Ball End tools feature a consistent 25° working angle. The Ball End feature saves time and tool users can absolutely count on every Bondhus Ball End tool to provide a 25° working angle. Period!

Stubby Ball End L-Wrenches

- BriteGuard™ Finish -

- Fits into tight spaces standard hex keys cannot
- Eliminates the need to trim and file the short arm
- Tighter inside radius means full smooth entry into screw head
- Chamfered short arm eliminates burrs
- Ball End inserts into a screw at a 25° angle

BriteGuard™ finish delivers superior corrosion protection



Sets	PART#	MODEL#	PCS	LENGTH	CONTENTS	QTY	LIST
Inch	16738	SBLX10B	10	Long	1/16, 5/64, 3/32, 7/64, 1/8, 9/64, 5/32, 3/16, 7/32, 1/4"	1	\$21.36
	16737	SBLX13B	13	Long	.050, 1/16, 5/64, 3/32, 7/64, 1/8, 9/64, 5/32, 3/16, 7/32, 1/4, 5/16, 3/8"	1	\$34.18
Metric	16792	SBLX7MB	7	Extra Long	1.5, 2, 2.5, 3, 4, 5, 6mm	1	\$16.96
	16799	SBLX9MB	9	Extra Long	1.5, 2, 2.5, 3, 4, 5, 6, 8, 10mm	1	\$27.71



SINGLE PACKAGING



Singles	SIZE	INCH		MM		PART#	QTY	LIST EA	PART#	QTY	LIST EA
		INCH	MM	INCH	MM						
LONG Inch	.050	2.8	72	0.14	4	26702	50	\$1.62	16702	5	\$1.77
	1/16	3.0	76	0.16	4	26703	50	\$1.62	16703	5	\$1.77
	5/64	3.2	81	0.27	7	26704	50	\$1.62	16704	5	\$1.77
	3/32	3.4	86	0.29	7	26705	50	\$1.66	16705	5	\$1.83
	7/64	3.6	90	0.30	8	26706	50	\$1.89	16706	5	\$2.11
	1/8	3.8	95	0.32	8	26707	50	\$1.95	16707	5	\$2.17
	9/64	4.0	101	0.33	8	26708	50	\$1.95	16708	5	\$2.17
	5/32	4.2	107	0.35	9	26709	50	\$2.03	16709	5	\$2.23
	3/16	4.5	114	0.39	10	26710	50	\$2.30	16710	5	\$2.55
	7/32	4.9	124	0.46	12	26711	25	\$2.78	16711	2	\$3.08
1/4	5.6	141	0.46	12	26712	25	\$3.24	16712	2	\$3.61	
5/16	6.0	152	0.57	14	26713	25	\$5.02	16713	2	\$5.59	
3/8	6.8	171	0.71	18	26714	25	\$7.10	16714	2	\$7.89	
EXTRA LONG Metric	1.27	2.7	69	0.14	4	26749	50	\$1.62	16749	5	\$1.77
	1.5	3.5	90	0.19	5	26750	50	\$1.62	16750	5	\$1.77
	2.0	3.9	100	0.27	7	26752	50	\$1.62	16752	5	\$1.77
	2.5	4.4	112	0.28	7	26754	50	\$1.66	16754	5	\$1.83
	3.0	5.0	126	0.32	8	26756	50	\$1.89	16756	5	\$2.11
	4.0	5.6	142	0.35	9	26760	50	\$2.03	16760	5	\$2.23
	5.0	6.3	160	0.40	10	26764	25	\$2.54	16764	2	\$2.81
	6	6.8	172	0.47	12	26768	25	\$3.38	16768	2	\$3.75
	8	7.7	195	0.57	14	26772	25	\$5.51	16772	2	\$6.11
	10	8.4	213	0.78	20	26776	25	\$7.99	16776	2	\$8.87

Did you know...?
Stubby tools have a tighter inside radius than standard hex keys, which saves time because the tight radius design reaches screws that even a hex key with a cut down short arm cannot.

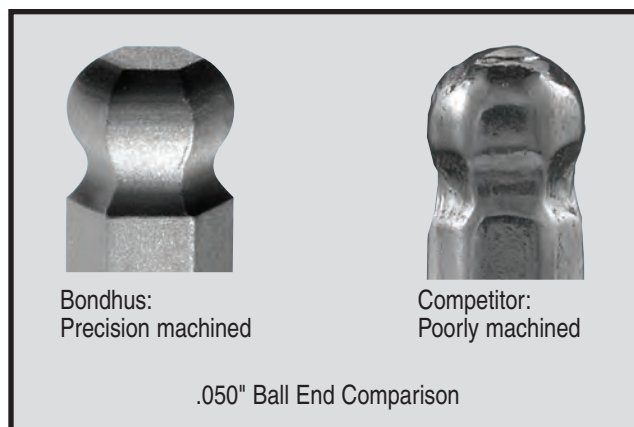

Hex End L-Wrenches

- BriteGuard™ Finish -

- Chamfered tool tips eliminate burrs and help tools seat in screw head
- Sharp corners transfer more torque to the screw and reduce stripping
- Precision machined for ease of use and superior fit

BriteGuard™ finish delivers superior corrosion protection



Yellow=Inch

Red=Metric

Hex End Tips

Sets	PART#	MODEL#	PCS	LENGTH	CONTENTS	QTY	LIST
Inch	16138	HLX10B	10	Long	1/16, 5/64, 3/32, 7/64, 1/8, 9/64, 5/32, 3/16, 7/32, 1/4"	1	\$9.07
	16136	HLX12B	12	Long	.050, 1/16, 5/64, 3/32, 7/64, 1/8, 9/64, 5/32, 3/16, 7/32, 1/4, 5/16"	1	\$12.94
	16137	HLX13B	13	Long	.050, 1/16, 5/64, 3/32, 7/64, 1/8, 9/64, 5/32, 3/16, 7/32, 1/4, 5/16, 3/8"	1	\$17.12
	16238	HLX10SB	10	Short	1/16, 5/64, 3/32, 7/64, 1/8, 9/64, 5/32, 3/16, 7/32, 1/4"	1	\$7.55
	16236	HLX12SB	12	Short	.050, 1/16, 5/64, 3/32, 7/64, 1/8, 9/64, 5/32, 3/16, 7/32, 1/4, 5/16"	1	\$9.12
	16237	HLX13SB	13	Short	.050, 1/16, 5/64, 3/32, 7/64, 1/8, 9/64, 5/32, 3/16, 7/32, 1/4, 5/16, 3/8"	1	\$12.22
Metric	17146	HLX6MB	6	Extra Long	1.5, 2, 2.5, 3, 4, 5mm	1	\$7.82
	17192	HLX7MB	7	Extra Long	1.5, 2, 2.5, 3, 4, 5, 6mm	1	\$10.16
	17199	HLX9MB	9	Extra Long	1.5, 2, 2.5, 3, 4, 5, 6, 8, 10mm	1	\$16.14
	17195	HLX15MB	15	Extra Long	1.27, 1.5, 2, 2.5, 3, 3.5, 4, 4.5, 5, 5.5, 6, 7, 8, 9, 10mm	1	\$28.85
	16246	HLX6MSB	6	Short	1.5, 2, 2.5, 3, 4, 5mm	1	\$6.30
	16292	HLX7MSB	7	Short	1.5, 2, 2.5, 3, 4, 5, 6mm	1	\$7.72
	16299	HLX9MSB	9	Short	1.5, 2, 2.5, 3, 4, 5, 6, 8, 10mm	1	\$11.30

17199 (Extra Long)

16292 (Short)

Singles	SIZE INCH MM				SINGLE PACKAGING			SIZE INCH MM				SINGLE PACKAGING										
	INCH	MM	INCH	MM	PART#	QTY	LIST EA	PART#	QTY	LIST EA	PART#	QTY	LIST EA	PART#	QTY	LIST EA						
Inch	Long							Short														
	.028	2.6	66	0.22	6	26100	50	\$0.53	16100	10	\$0.92	.028	1.2	31	0.22	6	26200	50	\$0.40	16200	10	\$0.67
	.035	2.7	68	0.34	9	26101	50	\$0.53	16101	10	\$0.92	.035	1.2	31	0.34	9	26201	50	\$0.40	16201	10	\$0.67
	.050	2.8	72	0.53	13	26102	50	\$0.35	16102	10	\$0.55	.050	1.6	42	0.53	13	26202	50	\$0.27	16202	10	\$0.45
	1/16	3.0	76	0.56	14	26103	50	\$0.40	16103	10	\$0.58	1/16	1.8	45	0.56	14	26203	50	\$0.27	16203	10	\$0.45
	5/64	3.2	81	0.61	15	26104	50	\$0.40	16104	10	\$0.58	5/64	1.9	48	0.61	15	26204	50	\$0.30	16204	10	\$0.53
	3/32	3.4	86	0.65	16	26105	50	\$0.51	16105	10	\$0.72	3/32	2.0	51	0.65	16	26205	50	\$0.30	16205	10	\$0.53
	7/64	3.6	90	0.70	18	26106	50	\$0.51	16106	10	\$0.72	7/64	2.1	54	0.70	18	26206	50	\$0.38	16206	10	\$0.55
	1/8	3.8	95	0.75	19	26107	50	\$0.51	16107	10	\$0.72	1/8	2.3	58	0.75	19	26207	50	\$0.38	16207	10	\$0.55
	9/64	4.0	101	0.80	20	26108	50	\$0.58	16108	10	\$0.85	9/64	2.4	61	0.80	20	26208	50	\$0.40	16208	10	\$0.58
	5/32	4.2	107	0.84	21	26109	50	\$0.58	16109	10	\$0.85	5/32	2.5	64	0.84	21	26209	50	\$0.40	16209	10	\$0.58
	3/16	4.5	114	0.94	24	26110	50	\$0.92	16110	10	\$1.25	3/16	2.8	70	0.94	24	26210	50	\$0.58	16210	10	\$0.72
	7/32	4.9	124	1.03	26	26111	25	\$1.51	16111	5	\$1.77	7/32	3.0	77	1.03	26	26211	25	\$0.95	16211	5	\$1.13
	1/4	5.3	133	1.13	29	26112	25	\$1.51	16112	5	\$1.77	1/4	3.3	83	1.13	29	26212	25	\$0.95	16212	5	\$1.13
	5/16	6.0	152	1.25	32	26113	25	\$2.63	16113	5	\$2.96	5/16	3.8	96	1.25	32	26213	25	\$1.51	16213	5	\$1.77
	3/8	6.8	171	1.38	35	26114	25	\$4.14	16114	5	\$4.61	3/8	4.3	108	1.38	35	26214	25	\$2.63	16214	5	\$2.96
7/16	7.5	191	1.50	38	-	-	-	16115	1	\$9.45	7/16	4.8	121	1.50	38	-	-	-	-	16215	1	\$6.04
1/2	7.8	198	1.63	41	-	-	-	16116	1	\$9.45	1/2	5.3	133	1.63	41	-	-	-	-	16216	1	\$6.04
9/16	9.0	229	1.75	44	-	-	-	16117	1	\$10.51	9/16	5.8	146	1.75	44	-	-	-	-	16217	1	\$7.62
5/8	9.8	248	1.88	48	-	-	-	16118	1	\$15.12	5/8	6.3	159	1.88	48	-	-	-	-	16218	1	\$9.86
3/4	11.3	286	2.13	54	-	-	-	16119	1	\$20.37	3/4	7.3	184	2.13	54	-	-	-	-	16219	1	\$15.25
Metric	Extra Long							Short														
	.71	2.6	66	0.22	6	27147	50	\$0.53	17147	10	\$0.92	.71	1.2	31	0.22	6	26247	50	\$0.40	16247	10	\$0.67
	.89	2.7	68	0.34	9	27148	50	\$0.53	17148	10	\$0.92	.89	1.2	31	0.34	9	26248	50	\$0.40	16248	10	\$0.67
	1.27	2.8	72	0.53	13	27149	50	\$0.36	17149	10	\$0.55	1.27	1.6	42	0.53	13	26249	50	\$0.27	16249	10	\$0.45
	1.5	3.5	90	0.53	14	27150	50	\$0.40	17150	10	\$0.58	1.5	1.7	44	0.53	14	26250	50	\$0.27	16250	10	\$0.45
	2.0	3.9	100	0.61	16	27152	50	\$0.40	17152	10	\$0.58	2.0	1.9	49	0.61	16	26252	50	\$0.30	16252	10	\$0.50
	2.5	4.4	112	0.69	17	27154	50	\$0.51	17154	10	\$0.72	2.5	2.1	54	0.69	17	26254	50	\$0.30	16254	10	\$0.50
	3.0	5.0	126	0.75	19	27156	50	\$0.51	17156	10	\$0.72	3.0	2.4	61	0.75	19	26256	50	\$0.38	16256	10	\$0.55
	3.5	5.2	133	0.85	21	27158	50	\$0.58	17158	1	\$0.85	3.5	2.6	65	0.85	21	26258	50	\$0.40	16258	1	\$0.58
	4.0	5.6	142	0.87	22	27160	50	\$0.58	17160	10	\$0.85	4.0	2.7	68	0.87	22	26260	50	\$0.40	16260	10	\$0.58
	4.5	5.9	151	1.00	25	27162	50	\$0.92	17162	1	\$1.25	4.5	2.9	73	1.00	25	26262	50	\$0.58	16262	1	\$0.72
	5.0	6.3	160	1.06	27	27164	50	\$0.92	17164	5	\$1.25	5.0	3.1	78	1.06	27	26264	50	\$0.58	16264	5	\$0.72
	5.5	6.8	172	1.14	29	27166	25	\$1.51	17166	1	\$1.77	5.5	3.3	83	1.14	29	26266	25	\$0.95	16266	1	\$1.13
	6	6.8	172	1.22	31	27168	25	\$1.51	17168	5	\$1.77	6	3.5	88	1.22	31	26268	25	\$0.95	16268	5	\$1.13
	7	7.2	184	1.30	33	27170	25	\$2.63	17170	1	\$2.96	7	3.7	93	1.30	33	26270	25	\$1.51	16270	1	\$1.77
	8	7.7	195	1.38	35	27172	25	\$2.63	17172	5	\$2.96	8	3.9	98	1.38	35	26272	25	\$1.51	16272	5	\$1.77
	9	8.0	202	1.46	37	27174	25	\$4.14	17174	1	\$4.61	9	4.0	102	1.46	37	26274	25	\$2.63	16274	1	\$2.96
	10	8.4	213	1.54	39	27176	10	\$4.14	17176	5	\$4.61	10	4.3	109	1.54	39	26276	10	\$2.63	16276	5	\$2.96
	11	7.9	200	1.63	42	27178	10	\$9.26	17178	1	\$9.45	11	4.5	115	1.63	42	26278	10	\$5.65	16278	1	\$6.04
12	8.7	220	1.73	44	27180	10	\$9.26	17180	1	\$9.45	12	4.8	122	1.73	44	26280	10	\$5.65	16280	1	\$6.04	
14	10.2	260	2.15	55	-	-	-	17184	1	\$10.51	14	5.4	136	2.15	55	-	-	-	-	16284	1	\$7.89
17	11.0	280	2.42	61	-	-	-	17186	1	\$14.45	17	6.1	156	2.42	61	-	-	-	-	16286	1	\$9.20
19	11.6	295	2.70	69	-	-	-	17188	1	\$19.05	19	6.9	175	2.72	69	-	-	-	-	16288	1	\$15.25

Ball End L-Wrenches

- GoldGuard™ Finish -

- Ball End inserts into a screw at a 25° angle
- Ball End saves time by quickly funneling tool into screw
- 25° angle allows natural hand and wrist movement
- Superior Ball End strength and working angle
- Works in hard to reach places

GoldGuard™ finish.
Real 14 karat Gold



Sets	PART#	MODEL#	PCS	LENGTH	CONTENTS	QTY	LIST
Inch	37938	BLX10G	10	Long	1/16, 5/64, 3/32, 7/64, 1/8, 9/64, 5/32, 3/16, 7/32, 1/4"	1	\$17.28
	37936	BLX12G	12	Long	.050, 1/16, 5/64, 3/32, 7/64, 1/8, 9/64, 5/32, 3/16, 7/32, 1/4, 5/16"	1	\$21.57
	37937	BLX13G	13	Long	.050, 1/16, 5/64, 3/32, 7/64, 1/8, 9/64, 5/32, 3/16, 7/32, 1/4, 5/16, 3/8"	1	\$27.66
Metric	38046	BLX6MG	6	Long	1.5, 2, 2.5, 3, 4, 5mm	1	\$10.22
	38092	BLX7MG	7	Long	1.5, 2, 2.5, 3, 4, 5, 6mm	1	\$13.69
	38099	BLX9MG	9	Long	1.5, 2, 2.5, 3, 4, 5, 6, 8, 10mm	1	\$22.39
	38095	BLX15MG	15	Long	1.27, 1.5, 2, 2.5, 3, 3.5, 4, 4.5, 5, 5.5, 6, 7, 8, 9, 10mm	1	\$37.60

Singles	SIZE	INCH	MM	INCH	MM	SINGLE PACKAGING			TAGGED/BARCODED		
						BULK	QTY	LIST EA	PART#	QTY	LIST EA
LONG Inch	.050	2.8	72	0.53	13	27902	50	\$1.13	37902	10	\$1.42
	1/16	3.0	76	0.56	14	27903	50	\$1.13	37903	10	\$1.42
	5/64	3.2	81	0.61	15	27904	50	\$1.13	37904	10	\$1.42
	3/32	3.4	86	0.65	16	27905	50	\$1.30	37905	10	\$1.48
	7/64	3.6	90	0.70	18	27906	50	\$1.44	37906	10	\$1.69
	1/8	3.8	95	0.75	19	27907	50	\$1.59	37907	10	\$1.76
	9/64	4.0	101	0.80	20	27908	50	\$1.59	37908	10	\$1.76
	5/32	4.2	107	0.84	21	27909	50	\$1.65	37909	10	\$1.82
	3/16	4.5	114	0.94	24	27910	50	\$1.86	37910	10	\$2.10
	7/32	4.9	124	1.03	26	27911	25	\$2.42	37911	5	\$2.51
	1/4	5.6	141	1.13	29	27912	25	\$2.81	37912	5	\$2.90
	5/16	6.0	152	1.25	32	27913	25	\$4.46	37913	5	\$4.60
	3/8	6.8	171	1.38	35	27914	25	\$6.26	37914	5	\$6.49
	7/16	7.5	191	1.50	38	-	-	-	37915	1	\$11.89
1/2	7.8	198	1.63	41	-	-	-	37916	1	\$14.86	
9/16	9.0	229	1.75	44	-	-	-	37917	1	\$18.91	
5/8	9.8	248	1.88	48	-	-	-	37918	1	\$21.62	
3/4	11.3	286	2.13	54	-	-	-	37919	1	\$32.42	

Did you know...?
Protanium® Steel tools are up to 20% stronger than competitor tools made from standard grades of steel.

LONG Metric	1.27	2.8	72	0.53	13	28049	50	\$1.13	38049	10	\$1.42
	1.5	3.0	77	0.53	14	28050	50	\$1.13	38050	10	\$1.42
	2.0	3.2	82	0.61	16	28052	50	\$1.13	38052	10	\$1.42
	2.5	3.5	88	0.69	17	28054	50	\$1.30	38054	10	\$1.48
	3.0	3.9	98	0.75	19	28056	50	\$1.44	38056	10	\$1.69
	3.5	3.9	100	0.85	21	28058	50	\$1.65	38058	1	\$1.82
	4.0	4.3	110	0.87	22	28060	50	\$1.65	38060	10	\$1.82
	4.5	4.5	114	1.00	25	28062	50	\$1.86	38062	1	\$2.10
	5.0	4.7	119	1.06	27	28064	50	\$2.08	38064	5	\$2.28
	5.5	4.9	124	1.14	29	28066	25	\$2.61	38066	1	\$2.70
	6	5.5	139	1.22	31	28068	25	\$2.90	38068	5	\$3.05
	7	5.5	140	1.30	33	28070	25	\$4.00	38070	1	\$4.12
	8	6.0	152	1.38	35	28072	25	\$4.75	38072	5	\$4.94
	9	6.2	159	1.46	37	28074	25	\$5.85	38074	1	\$5.87
	10	6.7	171	1.54	39	28076	10	\$7.16	38076	5	\$7.22
	11	7.9	200	1.63	42	28078	10	\$11.83	38078	1	\$11.89
	12	8.7	220	1.73	44	28080	10	\$11.83	38080	1	\$11.89
	14	10.2	260	2.15	55	-	-	-	38084	1	\$16.89
17	11.0	280	2.42	61	-	-	-	38086	1	\$25.67	
19	11.6	295	2.70	69	-	-	-	38088	1	\$32.42	

Hex End L-Wrenches

- GoldGuard™ Finish -

- Chamfered tool tips eliminate burrs and help tools seat in screw head
- Sharp corners transfer more torque to the screw and reduce stripping
- Precision machined for ease of use and superior fit

GoldGuard™ finish.
Real 14 karat Gold



Sets	PART#	MODEL#	PCS	LENGTH	CONTENTS	QTY	LIST
Inch	38138	HLX10G	10	Long	1/16, 5/64, 3/32, 7/64, 1/8, 9/64, 5/32, 3/16, 7/32, 1/4"	1	\$9.40
	38136	HLX12G	12	Long	.050, 1/16, 5/64, 3/32, 7/64, 1/8, 9/64, 5/32, 3/16, 7/32, 1/4, 5/16"	1	\$13.31
	38137	HLX13G	13	Long	.050, 1/16, 5/64, 3/32, 7/64, 1/8, 9/64, 5/32, 3/16, 7/32, 1/4, 5/16, 3/8"	1	\$17.56
	38238	HLX10SG	10	Short	1/16, 5/64, 3/32, 7/64, 1/8, 9/64, 5/32, 3/16, 7/32, 1/4"	1	\$7.77
	38236	HLX12SG	12	Short	.050, 1/16, 5/64, 3/32, 7/64, 1/8, 9/64, 5/32, 3/16, 7/32, 1/4, 5/16"	1	\$9.40
	38237	HLX13SG	13	Short	.050, 1/16, 5/64, 3/32, 7/64, 1/8, 9/64, 5/32, 3/16, 7/32, 1/4, 5/16, 3/8"	1	\$12.55
Metric	39146	HLX6MG	6	Long	1.5, 2, 2.5, 3, 4, 5mm	1	\$8.10
	39192	HLX7MG	7	Long	1.5, 2, 2.5, 3, 4, 5, 6mm	1	\$10.44
	39199	HLX9MG	9	Long	1.5, 2, 2.5, 3, 4, 5, 6, 8, 10mm	1	\$16.63
	39195	HLX15MG	15	Long	1.27, 1.5, 2, 2.5, 3, 3.5, 4, 4.5, 5, 5.5, 6, 7, 8, 9, 10mm	1	\$29.67
	38246	HLX6MSG	6	Short	1.5, 2, 2.5, 3, 4, 5mm	1	\$6.51
	38292	HLX7MSG	7	Short	1.5, 2, 2.5, 3, 4, 5, 6mm	1	\$7.94
	38299	HLX9MSG	9	Short	1.5, 2, 2.5, 3, 4, 5, 6, 8, 10mm	1	\$11.62

Singles	SINGLE PACKAGING							SINGLE PACKAGING													
	SIZE	INCH	MM	INCH	MM	PART#	QTY LIST EA	PART#	QTY LIST EA	SIZE	INCH	MM	INCH	MM	PART#	QTY LIST EA	PART#	QTY LIST EA			
Inch	Long							Short													
	.028	2.6	66	0.22	6	28100	50 \$0.54	38100	10 \$0.95	.028	1.2	31	0.22	6	28200	50 \$0.41	38200	10 \$0.68			
	.035	2.7	68	0.34	9	28101	50 \$0.54	38101	10 \$0.95	.035	1.2	31	0.34	9	28201	50 \$0.41	38201	10 \$0.68			
	.050	2.8	72	0.53	13	28102	50 \$0.37	38102	10 \$0.57	.050	1.6	42	0.53	13	28202	50 \$0.28	38202	10 \$0.47			
	1/16	3.0	76	0.56	14	28103	50 \$0.41	38103	10 \$0.60	1/16	1.8	45	0.56	14	28203	50 \$0.28	38203	10 \$0.47			
	5/64	3.2	81	0.61	15	28104	50 \$0.41	38104	10 \$0.60	5/64	1.9	48	0.61	15	28204	50 \$0.32	38204	10 \$0.54			
	3/32	3.4	86	0.65	16	28105	50 \$0.53	38105	10 \$0.75	3/32	2.0	51	0.65	16	28205	50 \$0.32	38205	10 \$0.54			
	7/64	3.6	90	0.70	18	28106	50 \$0.53	38106	10 \$0.75	7/64	2.1	54	0.70	18	28206	50 \$0.38	38206	10 \$0.57			
	1/8	3.8	95	0.75	19	28107	50 \$0.53	38107	10 \$0.75	1/8	2.3	58	0.75	19	28207	50 \$0.38	38207	10 \$0.57			
	9/64	4.0	101	0.80	20	28108	50 \$0.60	38108	10 \$0.88	9/64	2.4	61	0.80	20	28208	50 \$0.41	38208	10 \$0.60			
	5/32	4.2	107	0.84	21	28109	50 \$0.60	38109	10 \$0.88	5/32	2.5	64	0.84	21	28209	50 \$0.41	38209	10 \$0.60			
	3/16	4.5	114	0.94	24	28110	50 \$0.95	38110	10 \$1.28	3/16	2.8	70	0.94	24	28210	50 \$0.60	38210	10 \$0.75			
	7/32	4.9	124	1.03	26	28111	25 \$1.55	38111	5 \$1.82	7/32	3.0	77	1.03	26	28211	25 \$0.97	38211	5 \$1.16			
	1/4	5.3	133	1.13	29	28112	25 \$1.55	38112	5 \$1.82	1/4	3.3	83	1.13	29	28212	25 \$0.97	38212	5 \$1.16			
	5/16	6.0	152	1.25	32	28113	25 \$2.70	38113	5 \$3.05	5/16	3.8	96	1.25	32	28213	25 \$1.55	38213	5 \$1.82			
	3/8	6.8	171	1.38	35	28114	25 \$4.26	38114	5 \$4.74	3/8	4.3	108	1.38	35	28214	25 \$2.70	38214	5 \$3.05			
	7/16	7.5	191	1.50	38	-	-	38115	1 \$9.72	7/16	4.8	121	1.50	38	-	-	38215	1 \$6.22			
	1/2	7.8	198	1.63	41	-	-	38116	1 \$9.72	1/2	5.3	133	1.63	41	-	-	38216	1 \$6.22			
	9/16	9.0	229	1.75	44	-	-	38117	1 \$10.82	9/16	5.8	146	1.75	44	-	-	38217	1 \$7.82			
5/8	9.8	248	1.88	48	-	-	38118	1 \$15.55	5/8	6.3	159	1.88	48	-	-	38218	1 \$10.14				
3/4	11.3	286	2.13	54	-	-	38119	1 \$20.95	3/4	7.3	184	2.13	54	-	-	38219	1 \$15.67				
Metric	Long							Short													
	.71	2.6	66	0.22	6	29147	50 \$0.54	39147	10 \$0.95	.71	1.2	31	0.22	6	28247	50 \$0.41	38247	10 \$0.68			
	.89	2.7	68	0.34	9	29148	50 \$0.54	39148	10 \$0.95	.89	1.2	31	0.34	9	28248	50 \$0.41	38248	10 \$0.68			
	1.27	2.8	72	0.53	13	29149	50 \$0.37	39149	10 \$0.57	1.27	1.6	42	0.53	13	28249	50 \$0.28	38249	10 \$0.47			
	1.5	3.0	77	0.53	14	29150	50 \$0.41	39150	10 \$0.60	1.5	1.7	44	0.53	14	28250	50 \$0.28	38250	10 \$0.47			
	2.0	3.2	82	0.61	16	29152	50 \$0.41	39152	10 \$0.60	2.0	1.9	49	0.61	16	28252	50 \$0.32	38252	10 \$0.51			
	2.5	3.5	88	0.69	17	29154	50 \$0.53	39154	10 \$0.75	2.5	2.1	54	0.69	17	28254	50 \$0.32	38254	10 \$0.51			
	3.0	3.9	98	0.75	19	29156	50 \$0.53	39156	10 \$0.75	3.0	2.4	61	0.75	19	28256	50 \$0.38	38256	10 \$0.57			
	3.5	3.9	100	0.85	21	29158	50 \$0.60	39158	1 \$0.88	3.5	2.6	65	0.85	21	28258	50 \$0.41	38258	1 \$0.60			
	4.0	4.3	110	0.87	22	29160	50 \$0.60	39160	10 \$0.88	4.0	2.7	68	0.87	22	28260	50 \$0.41	38260	10 \$0.60			
	4.5	4.5	114	1.00	25	29162	50 \$0.95	39162	1 \$1.28	4.5	2.9	73	1.00	25	28262	50 \$0.60	38262	1 \$0.75			
	5.0	4.7	119	1.06	27	29164	50 \$0.95	39164	5 \$1.28	5.0	3.1	78	1.06	27	28264	50 \$0.60	38264	5 \$0.75			
	5.5	4.9	124	1.14	29	29166	25 \$1.55	39166	1 \$1.82	5.5	3.3	83	1.14	29	28266	25 \$0.97	38266	1 \$1.16			
	6	5.5	139	1.22	31	29168	25 \$1.55	39168	5 \$1.82	6	3.5	88	1.22	31	28268	25 \$0.97	38268	5 \$1.16			
	7	5.5	140	1.30	33	29170	25 \$2.70	39170	1 \$3.05	7	3.7	93	1.30	33	28270	25 \$1.55	38270	1 \$1.82			
	8	6.0	152	1.38	35	29172	25 \$2.70	39172	5 \$3.05	8	3.9	98	1.38	35	28272	25 \$1.55	38272	5 \$1.82			
	9	6.2	159	1.46	37	29174	25 \$4.26	39174	1 \$4.74	9	4.0	102	1.46	37	28274	25 \$2.70	38274	1 \$3.05			
	10	6.7	171	1.54	39	29176	10 \$4.26	39176	5 \$4.74	10	4.3	109	1.54	39	28276	10 \$2.70	38276	5 \$3.05			
	11	7.9	200	1.63	42	29178	10 \$9.53	39178	1 \$9.72	11	4.5	115	1.63	42	28278	10 \$5.81	38278	1 \$6.22			
12	8.7	220	1.73	44	29180	10 \$9.53	39180	1 \$9.72	12	4.8	122	1.73	44	28280	10 \$5.81	38280	1 \$6.22				
14	10.2	260	2.15	55	-	-	39184	1 \$10.82	14	5.4	136	2.15	55	-	-	38284	1 \$8.11				
17	11.0	280	2.42	61	-	-	39186	1 \$14.86	17	6.1	156	2.42	61	-	-	38286	1 \$9.45				
19	11.6	295	2.70	69	-	-	39188	1 \$19.59	19	6.9	175	2.72	69	-	-	38288	1 \$15.67				

HexPro™ Pivot Head Wrenches

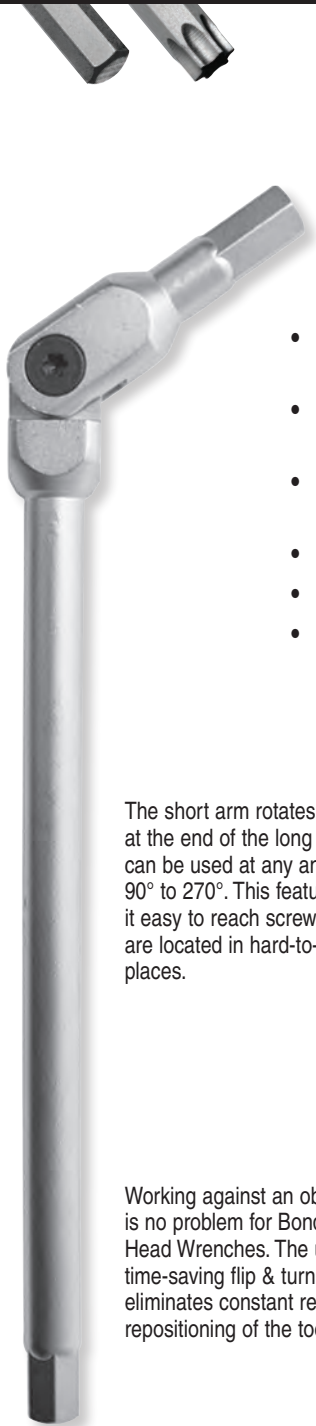

- Fits Inch and Metric Hex, TORX®, and Star screws
- Available in 25 sizes to cover most fastener heads
- Heat treated high quality industrial tool steel
- Long handles for extra reach
- Matte chrome finish to prevent corrosion
- Lifetime Warranty

The short arm rotates on a hinge at the end of the long arm and can be used at any angle from 90° to 270°. This feature makes it easy to reach screw heads that are located in hard-to-reach places.



Working against an obstruction is no problem for Bondhus Pivot Head Wrenches. The unique time-saving flip & turn feature eliminates constant removal and repositioning of the tool.



This precision machined tool features smooth surfaces and radiused edges where the users hand holds the tool, making it comfortable to use.



Pivot Head Hex and TORX® Wrenches



Pivot Head Hex and TORX® wrenches allow tool users to insert wrench into socket head screw one time, pivoting around obstacles.



Joints are engineered to be as small as possible without weakening the tool.

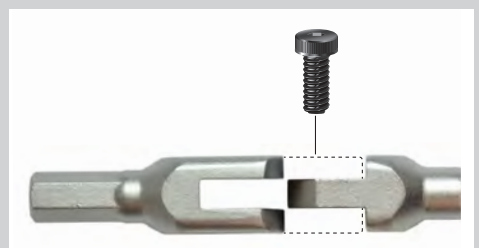

Forged hinges provide a simple, effective, patented design. Fewer pieces make Pivot Head Hex and TORX® wrenches stronger and less likely to break than competitors.

HexPro™ Pivot Head Wrenches

- Chrome Finish -

L-Wrenches

Sets	PART#	MODEL#	PCS	PACKED IN	CARD	POUCH	CONTENTS	QTY	LIST
Inch Hex	00009	HP5-IC-09	5	Box		✓	3/16, 7/32, 1/4, 5/16, 3/8"	1	\$57.00
	00017	HP8-IC-17	8	Box		✓	1/8, 9/64, 5/32, 3/16, 7/32, 1/4, 5/16, 3/8"	1	\$72.85
	00040	HP5-IC-40R	5	Transparent Clamshell	*ROY		3/16, 7/32, 1/4, 5/16, 3/8"	1	\$49.95
	00048	HP5-IC-48R	5	Transparent Clamshell	*ROY	✓	3/16, 7/32, 1/4, 5/16, 3/8"	1	\$54.95
	00060	HP5-IC-60B	5	Transparent Clamshell	Blue		3/16, 7/32, 1/4, 5/16, 3/8"	1	\$49.95
	00068	HP5-IC-68B	5	Transparent Clamshell	Blue	✓	3/16, 7/32, 1/4, 5/16, 3/8"	1	\$54.95
Metric Hex	00005	HP5-IC-05	5	Box		✓	4, 5, 6, 8, 10mm	1	\$57.00
	00010	HP6-IC-10	6	Box		✓	3, 4, 5, 6, 8, 10mm	1	\$60.15
	00051	HP5-IC-51R	5	Transparent Clamshell	*ROY		4, 5, 6, 8, 10mm	1	\$49.95
	00053	HP5-IC-53R	5	Transparent Clamshell	*ROY	✓	4, 5, 6, 8, 10mm	1	\$54.95
	00070	HP5-IC-70B	5	Transparent Clamshell	Blue		4, 5, 6, 8, 10mm	1	\$49.95
	00073	HP5-IC-73B	5	Transparent Clamshell	Blue	✓	4, 5, 6, 8, 10mm	1	\$54.95
TORX®	00019	SP5-IC-19	5	Box		✓	T15, T20, T25, T27, T30	1	\$55.70
	00018	SP5-IC-18	5	Box		✓	T40, T45, T47, T50, T55	1	\$58.55
	00015	SP6-IC-15	6	Box		✓	T25, T27, T30, T40, T45, T50	1	\$68.15
	00022	SP10-IC-22	10	Box		✓	T15, T20, T25, T27, T30, T40, T45, T47, T50, T55	1	\$110.05
	00055	SP5-IC-55R	5	Transparent Clamshell	*ROY		T25, T30, T40, T45, T50	1	\$49.95
	00058	SP5-IC-58R	5	Transparent Clamshell	*ROY	✓	T25, T30, T40, T45, T50	1	\$54.95
	00075	SP5-IC-75B	5	Transparent Clamshell	Blue		T25, T30, T40, T45, T50	1	\$49.95
	00078	SP5-IC-78B	5	Transparent Clamshell	Blue	✓	T25, T30, T40, T45, T50	1	\$54.95



Pouch



*ROY - red, orange & yellow card

Singles	SIZE	PACKAGED		TAGGED/BARCODED							
		INCH	MM	PART#	QTY	LIST EA	PART#	QTY	LIST EA		
Inch	1/8	3.8	97	1.10	28	88007	1	\$9.05	88707	1	\$9.05
	9/64	3.8	97	1.10	28	88008	1	\$9.20	88708	1	\$9.20
	5/32	4.2	108	1.20	31	88009	1	\$9.35	88709	1	\$9.35
	3/16	4.6	118	1.30	33	88010	1	\$9.80	88710	1	\$9.80
	7/32	5.0	128	1.40	36	88011	1	\$10.20	88711	1	\$10.20
	1/4	5.4	138	1.60	41	88012	1	\$10.80	88712	1	\$10.80
	5/16	6.4	163	1.90	48	88013	1	\$11.70	88713	1	\$11.70
	3/8	7.0	177	2.00	51	88014	1	\$12.90	88714	1	\$12.90
Metric	3	3.8	97	1.10	28	88056	1	\$9.05	88756	1	\$9.05
	4	4.2	108	1.20	31	88060	1	\$9.35	88760	1	\$9.35
	5	4.6	118	1.30	33	88064	1	\$9.55	88764	1	\$9.55
	6	5.4	138	1.60	41	88068	1	\$10.30	88768	1	\$10.30
	7	6.4	163	1.90	48	88070	1	\$11.00	88770	1	\$11.00
	8	6.4	163	1.90	48	88072	1	\$11.70	88772	1	\$11.70
	10	7.0	177	2.00	51	88076	1	\$13.50	88776	1	\$13.50



Singles	SIZE	PACKAGED		TAGGED/BARCODED							
		INCH	MM	PART#	QTY	LIST EA	PART#	QTY	LIST EA		
TORX®	T15	4.2	108	1.20	31	88215	1	\$10.25	88715	1	\$10.25
	T20	4.2	108	1.20	31	88220	1	\$10.25	88720	1	\$10.25
	T25	4.6	118	1.30	33	88225	1	\$10.35	88725	1	\$10.35
	T27	4.6	118	1.30	33	88227	1	\$10.40	88727	1	\$10.40
	T30	4.6	118	1.30	33	88230	1	\$10.55	88730	1	\$10.55
	T40	5.4	138	1.60	41	88240	1	\$10.55	88740	1	\$10.55
	T45	6.4	163	1.90	48	88245	1	\$12.90	88745	1	\$12.90
	T47	6.4	163	1.90	48	88247	1	\$12.90	88747	1	\$12.90
	T50	6.4	163	1.90	48	88250	1	\$12.90	88750	1	\$12.90
	T55	7.0	177	2.00	51	88255	1	\$12.90	88755	1	\$12.90

TORX® Tip Tools

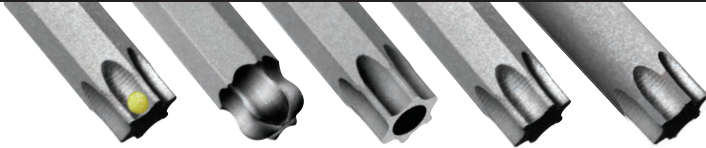

- Fits in both TORX® and TORX PLUS® fasteners
- Fits in Star and Star Plus fasteners
- A full range of tip sizes from T5 to T100
- The only TORX® tools made with Protanium® steel



Color-Coded
 TORX®



High Torque Steel:

Up to 20% stronger, with more torque and twice the wear resistance of standard grades of steel.

FINISH OPTIONS:









Corrosion-resistant finish:

Environmentally safe, provides better tool grip, resists solvents and is 5 times more corrosion resistant than competitor finishes.

Bondhus TORX® Tip Tools

Bondhus TORX® Tip tools are made to the same high standards as every tool we make. Our TORX® Tip tools are precision machined, available in several handle and tip types, and are the only TORX® tools made from Protanium® High Torque Steel. Bondhus TORX® and TORX PLUS® Tip tools fit TORX®, Star and Star Plus screws.

	L-Wrenches	27-28
	Wing and Flag Tools	29
	Fold Ups	31-33
	T-Handles	41
	Screwdrivers	46-47
	Socket Bits	55

TORX® and TORX PLUS® are registered trademarks of Acument Intellectual Properties, LLC.

TORX® L-Wrenches

- ProGuard™ Finish -

- Fits all TORX® and Star screws
- Broad contact surface provides deep lobe engagement
- Straight, vertical sidewalls increase tool engagement and virtually eliminates camout

ProGuard™ finish delivers superior corrosion protection

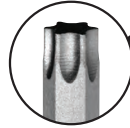

TORX® Tips

L-Wrenches

Tools are in color coded cases for easy recognition
Green=TORX®

Sets	PART#	MODEL#	PCS	LENGTH	CONTENTS	QTY	LIST
TORX®	31832	TLX8S	8	Long	T6, T7, T8, T9, T10, T15, T20, T25	1	\$19.15
	31834	TLX8	8	Long	T9, T10, T15, T20, T25, T27, T30, T40	1	\$16.51
	31732	TLXS8S	8	Short	T6, T7, T8, T9, T10, T15, T20, T25	1	\$16.66
	31734	TLXS8	8	Short	T9, T10, T15, T20, T25, T27, T30, T40	1	\$14.39
	12699	TLX9S	9	Short	T10, T15, T20, T25, T27, T30, T40, T45, T50 (in pouch)	1	\$20.49
	31737	TLX13S	13	Short	T7, T8, T9, T10, T15, T20, T25, T27, T30, T40, T45, T50, T55 (in pouch)	1	\$30.17



Singles	Long				Short																	
	SIZE	INCH	MM	PART#	QTY	LIST EA	PART#	QTY	LIST EA													
TORX®	T6	2.1	55	0.65	16	32806	25	\$3.05	31806	5	\$3.39	T5	0.9	23	0.65	16	32705	25	\$2.64	31705	5	\$2.93
	T7	2.4	61	0.65	16	32807	25	\$2.74	31807	5	\$3.04	T6	1.1	29	0.65	16	32706	25	\$2.64	31706	5	\$2.93
	T8	2.6	67	0.65	16	32808	25	\$2.74	31808	5	\$3.04	T7	1.4	35	0.65	16	32707	25	\$2.34	31707	5	\$2.64
	T9	2.9	74	0.65	16	32809	25	\$2.74	31809	5	\$3.04	T8	1.6	42	0.65	16	32708	25	\$2.34	31708	5	\$2.64
	T10	3.2	80	0.73	19	32810	25	\$1.29	31810	5	\$1.69	T9	1.9	48	0.65	16	32709	25	\$2.34	31709	5	\$2.64
	T15	3.3	84	0.78	20	32815	25	\$1.40	31815	5	\$1.76	T10	2.2	55	0.73	19	32710	25	\$1.35	31710	5	\$1.46
	T20	3.6	91	0.78	20	32820	25	\$1.50	31820	5	\$1.82	T15	2.3	59	0.78	20	32715	25	\$1.35	31715	5	\$1.52
	T25	3.8	98	0.88	22	32825	25	\$1.76	31825	5	\$1.94	T20	2.6	66	0.78	20	32720	25	\$1.46	31720	5	\$1.64
	T27	4.2	106	0.95	24	32827	25	\$1.76	31827	5	\$1.99	T25	2.8	72	0.88	22	32725	25	\$1.52	31725	5	\$1.69
	T30	4.6	116	1.03	26	32830	25	\$1.97	31830	5	\$2.23	T27	3.2	81	0.95	24	32727	25	\$1.58	31727	5	\$1.76
	T40	4.9	125	1.11	28	32840	25	\$2.17	31840	5	\$2.40	T30	3.6	90	1.03	26	32730	25	\$1.69	31730	5	\$1.87
	T45	5.4	138	1.20	30	32845	10	\$2.74	31845	2	\$3.27	T40	3.9	99	1.11	28	32740	25	\$1.87	31740	5	\$2.10
	T50	6.2	156	1.25	32	32850	10	\$3.36	31850	2	\$4.10	T45	3.9	98	1.20	30	32745	10	\$2.34	31745	2	\$2.58
	T55	6.7	171	1.36	34	32855	10	\$5.38	31855	2	\$6.15	T50	3.8	97	1.25	32	32750	10	\$2.64	31750	2	\$2.93
	T60	7.2	182	1.75	44	32860	10	\$7.13	31860	2	\$8.08	T55	3.8	95	1.36	34	32755	10	\$4.51	31755	2	\$4.98
													T60	3.7	93	1.75	44	32760	10	\$6.31	31760	2

ProHold® TORX® L-Wrenches

- ProGuard™ Finish -

- Fits all TORX® and Star screws
- Holds screw tight on the tool EVERY TIME
- Button is non-magnetic
- Broad contact surface provides deep lobe engagement

ProGuard™ finish delivers superior corrosion protection

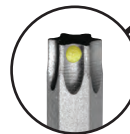

The ProHold® TORX® Tip holds screw securely

Tools are in color coded cases for easy recognition
Green=TORX®

Set	PART#	MODEL#	PCS	LENGTH	CONTENTS	QTY	LIST
TORX®	71834	PHTX8	8	Long	T9, T10, T15, T20, T25, T27, T30, T40	1	\$24.84



Singles	SIZE	INCH	MM	INCH	MM	PART#	QTY	LIST EA	PART#	QTY	LIST EA
LONG TORX®	T9	2.9	74	0.65	16	72809	25	\$4.10	71809	5	\$4.55
	T10	3.2	80	0.73	19	72810	25	\$2.05	71810	5	\$2.59
	T15	3.3	84	0.78	20	72815	25	\$2.34	71815	5	\$2.64
	T20	3.6	91	0.78	20	72820	25	\$2.45	71820	5	\$2.74
	T25	3.8	98	0.88	22	72825	25	\$2.64	71825	5	\$2.90
	T27	4.2	106	0.95	24	72827	25	\$2.69	71827	5	\$2.95
	T30	4.6	116	1.03	26	72830	25	\$2.98	71830	5	\$3.36
	T40	4.9	125	1.11	28	72840	25	\$3.27	71840	5	\$3.62
	T45	5.4	138	1.20	30	72845	10	\$4.44	71845	2	\$4.92
	T50	6.2	156	1.25	32	72850	10	\$5.55	71850	2	\$6.16
	T55	6.7	171	1.36	34	72855	10	\$8.31	71855	2	\$9.26
T60	7.2	182	1.75	44	72860	10	\$10.87	71860	2	\$12.11	

TORX® and TORX PLUS® are registered trademarks of Acument Intellectual Properties, LLC.

BallStar™ Tip L-Wrenches

- ProGuard™ Finish -

- Fits all TORX® and Star screws
- Ball End inserts into screws at a 20° angle
- Ball End saves time by quickly funneling tool into screw
- Superior Ball End strength and working angle
- Works in hard to reach places

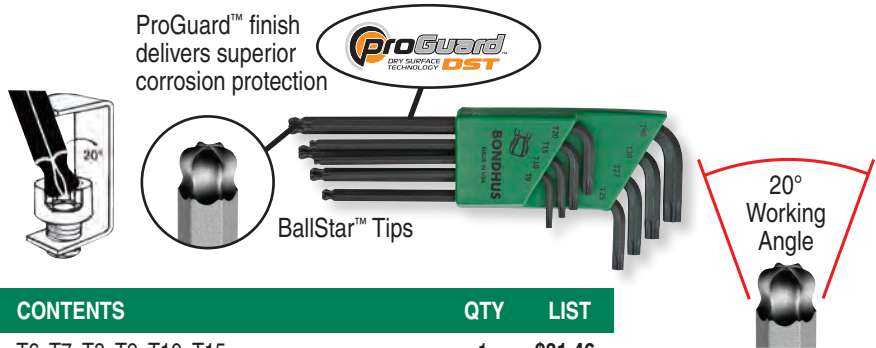

Sets	PART#	MODEL#	PCS	LENGTH	CONTENTS	QTY	LIST
BALL STAR™	11346	LTX6	6	Long	T6, T7, T8, T9, T10, T15	1	\$31.46
	11331	LTX8S	8	Long	T6, T7, T8, T9, T10, T15, T20, T25	1	\$43.52
	11332	LTX8	8	Long	T9, T10, T15, T20, T25, T27, T30, T40	1	\$49.01

TAGGED/BARCODED

Singles	SIZE	INCH	MM	INCH	MM	PART#	QTY	LIST EA
BALL STAR™	T6	2.1	55	0.65	16	11706	5	\$5.07
	T7	2.4	61	0.65	16	11707	5	\$5.07
	T8	2.6	67	0.65	16	11708	5	\$5.07
	T9	2.9	74	0.65	16	11709	5	\$5.07
	T10	3.2	80	0.73	19	11710	5	\$5.49
	T15	3.3	84	0.78	20	11715	5	\$5.68
	T20	3.6	91	0.78	20	11720	5	\$5.85
	T25	3.8	98	0.88	22	11725	5	\$6.28
	T27	4.2	106	0.95	24	11727	5	\$6.49
	T30	4.6	116	1.03	26	11730	5	\$6.68
	T40	4.9	125	1.11	28	11740	5	\$7.48
	T45	5.4	138	1.20	30	11745	1	\$8.91
	T50	6.2	156	1.25	32	11750	1	\$9.93
T55	6.7	171	1.36	34	11755	1	\$13.39	

Did you know...?

BallStar™ tools work at a 20° angle; screws can be turned continuously without constantly taking the tool out of the screw, repositioning it and reinserting it, even at angles up to 20°.

Tamper Resistant TORX® L-Wrenches

- ProGuard™ Finish -

- Fits all TORX® and Star tamper resistant screws
- Broad contact surface provides deep lobe engagement
- Straight, vertical sidewalls increase tool engagement and virtually eliminates camout



Sets	PART#	MODEL#	PCS	LENGTH	CONTENTS	QTY	LIST
TORX®	32432	TR-TL8S	8	Long	TR6, TR7, TR8, TR9, TR10, TR15, TR20, TR25	1	\$29.24
	32434	TR-TL8	8	Long	TR9, TR10, TR15, TR20, TR25, TR27, TR30, TR40	1	\$25.00

SINGLE PACKAGING

BULK

TAGGED/BARCODED

Singles	SIZE	INCH	MM	INCH	MM	PART#	QTY	LIST EA	PART#	QTY	LIST EA
LONG TORX®	TR6	2.1	55	0.65	16	33406	25	\$4.55	32406	2	\$5.07
	TR7	2.4	61	0.65	16	33407	25	\$4.22	32407	2	\$4.68
	TR8	2.6	67	0.65	16	33408	25	\$4.22	32408	2	\$4.68
	TR9	2.9	74	0.65	16	33409	25	\$4.22	32409	2	\$4.68
	TR10	3.2	80	0.73	19	33410	25	\$2.23	32410	2	\$2.58
	TR15	3.3	84	0.78	20	33415	25	\$2.28	32415	2	\$2.69
	TR20	3.6	91	0.78	20	33420	25	\$2.40	32420	2	\$2.80
	TR25	3.8	98	0.88	22	33425	25	\$2.51	32425	2	\$2.93
	TR27	4.2	106	0.95	24	33427	25	\$2.75	32427	2	\$3.04
	TR30	4.6	116	1.03	26	33430	25	\$2.79	32430	2	\$3.34
	TR40	4.9	125	1.11	28	33440	25	\$2.93	32440	2	\$3.45

Did you know...?

ProGuard® protection is a permanent solution that does not wipe off like common oil and black oxide finishes; tools remain in good condition with up to 5 times the resistance to rust and corrosion.

TORX® Wing Tools

- ProGuard™ Finish -

- Fits all TORX® and TORX PLUS® screws
- Fits all Star and Star Plus screws
- ComfortGrip Handles – soft rubber outer coating for maximum comfort and grip
- Broad contact surface provides deep lobe engagement
- Straight, vertical sidewalls increase tool engagement and virtually eliminates camout

ProGuard™ finish delivers superior corrosion protection



Sets	PART#	MODEL#	PCS	TIP	CONTENTS	QTY	LIST
TORX®	34745	TWX7	7	TORX®	T6, T7, T8, T9, T10, T15, T20	1	\$29.29
	33945	TPWX7	7	TORX PLUS®	IP 6, IP 7, IP 8, IP 9, IP 10, IP 15, IP 20	1	\$33.74



Singles	SIZE	INCH	MM	PART#	QTY	LIST EA
TORX®						
	T6	1.5	39	34706	2	\$3.67
	T7	1.5	39	34707	2	\$3.67
	T8	1.5	39	34708	2	\$3.67
	T9	1.5	39	34709	2	\$3.67
	T10	1.5	39	34710	2	\$3.67
	T15	1.5	39	34715	2	\$3.67
	T20	1.5	39	34720	2	\$3.67

Singles	SIZE	INCH	MM	PART#	QTY	LIST EA
TORX PLUS®						
	6 IP	2.0	52	33906	2	\$3.89
	7 IP	2.0	52	33907	2	\$3.89
	8 IP	2.0	52	33908	2	\$3.89
	9 IP	2.0	52	33909	2	\$4.38
	10 IP	2.0	52	33910	2	\$4.38
	15 IP	2.0	52	33915	2	\$4.65
	20 IP	2.0	52	33920	2	\$5.13



33945

TORX® Flag Tools

- ProGuard™ Finish -

- Fits all TORX® and TORX PLUS® screws
- Fits all Star and Star Plus screws
- ComfortGrip Handles – soft rubber outer coating for maximum comfort and grip
- Broad contact surface provides deep lobe engagement
- Straight, vertical sidewalls increase tool engagement and virtually eliminates camout

ProGuard™ finish delivers superior corrosion protection



Sets	PART#	MODEL#	PCS	TIP	CONTENTS	QTY	LIST
TORX®	34445	TFX7	7	TORX®	T6, T7, T8, T9, T10, T15, T20	1	\$28.05
	35045	TPFX7	7	TORX PLUS®	IP 6, IP 7, IP 8, IP 9, IP 10, IP 15, IP 20	1	\$32.55

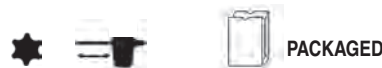

Singles	SIZE	INCH	MM	PART#	QTY	LIST EA
TORX®						
	T5	1.5	39	34405	2	\$3.52
	T6	1.5	39	34406	2	\$3.52
	T7	1.5	39	34407	2	\$3.52
	T8	1.5	39	34408	2	\$3.52
	T9	1.5	39	34409	2	\$3.52
	T10	1.5	39	34410	2	\$3.52
	T15	1.5	39	34415	2	\$3.52
	T20	1.5	39	34420	2	\$3.52

Singles	SIZE	INCH	MM	PART#	QTY	LIST EA
TORX PLUS®						
	-	-	-	-	-	-
	6 IP	2.0	52	35006	2	\$3.73
	7 IP	2.0	52	35007	2	\$3.73
	8 IP	2.0	52	35008	2	\$3.73
	9 IP	2.0	52	35009	2	\$4.22
	10 IP	2.0	52	35010	2	\$4.22
	15 IP	2.0	52	35015	2	\$4.43
	20 IP	2.0	52	35020	2	\$4.92



34445

Fold Ups



- Patented handle design makes every job faster and easier
- Durable GorillaGrip® handle is stronger than steel handles
- Tool user can adjust tool tension

Color-Coded

- Inch
- Metric
- TORX®
- Inch/Metric
- Motorcycle
- Utility



High Torque Steel:

Up to 20% stronger, with more torque and twice the wear resistance of standard grades of steel.

FINISH OPTIONS:



Corrosion-resistant finish:

Environmentally safe, provides better tool grip, resists solvents and is 5 times more corrosion resistant than competitor finishes.



Next generation chrome finish:

Traditional plated tool look with superior protection and durability.



Real 14 karat gold finish:

Superior protection and durability over traditional chrome and the look and shine of real gold.

Designed with the Tool User in mind

A Bondhus Fold Up is a tool for life. When designing the GorillaGrip® Fold Up, Bondhus engineers eliminated the problems of the average folding tool. GorillaGrip® Fold Up tools are stronger, more comfortable and easier to use.

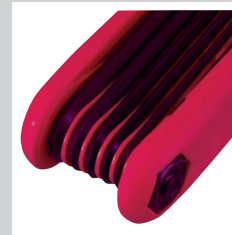

Patented Flutes allow for easy selection of one tool at a time.



Blades are accessed from both the top and bottom, eliminating the constant 'unstacking' of blades.



Turn & Flip Feature eliminates constant removal and repositioning in screw head when working against obstructions.



90° stop converts the tool into a non-stop, time saving, speed wrench.

TORX® and TORX PLUS® are trademarks of Acument Intellectual Properties, LLC

GorillaGrip® Fold Up Multi Packs

- ProGuard™ Finish -

- Assembled from our most popular Fold Up sets
- Multiple Fold Up sets per package
- Tip selections include Hex End and TORX® Tip

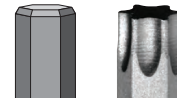
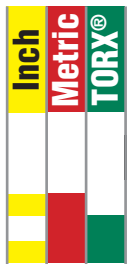

PART#	MODEL#	PCS	CONTENTS	QTY	LIST
12522	HF16	16	12589 (5/64-1/4") + 12587 (2-8mm)	1	\$15.11
12544	HF15	15	12587 (2-8mm) + 12634 (T9-T40)	1	\$22.30
12533	HF24	24	12589 (5/64-1/4") + 12587 (2-8mm) + 12634 (T9-T40)	1	\$29.55

12522

Hex End GorillaGrip® Fold Ups

- ProGuard™ Finish -

- Chamfered tool tips eliminate burrs and help tools seat in screws
- World's strongest handle
- Speed-Wrench feature
- Tools open from both the top and bottom
- Molded-in 90° stop
- Patented spacers between tools



ProGuard™ finish delivers superior corrosion protection



Hex End Tips

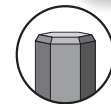

Sets	PART#	MODEL#	PCS	CONTENTS	QTY	LIST
Inch	12591	HF9S	9	.050, 1/16, 5/64, 3/32, 7/64, 1/8, 9/64, 5/32, 3/16"	1	\$6.00
	12589	HF9	9	5/64, 3/32, 7/64, 1/8, 9/64, 5/32, 3/16, 7/32, 1/4"	1	\$7.76
	12585	HF5	5	3/16, 7/32, 1/4, 5/16, 3/8"	1	\$10.97
Metric	12592	HF7MS	7	1.5, 2, 2.5, 3, 4, 5, 6mm	1	\$6.26
	12587	HF7M	7	2, 2.5, 3, 4, 5, 6, 8mm	1	\$8.33
	12595	HF6M	6	3, 4, 5, 6, 8, 10mm	1	\$11.64
Inch/Metric	12550	HF12	12	5/64, 3/32, 7/64, 1/8, 9/64, 5/32" 1.5, 2, 2.5, 3, 4, 5mm	1	\$10.66



Ball End GorillaGrip® Fold Ups

- ProGuard™ Finish -

- Ball End inserts into a screw at a 25° angle
- World's strongest handle
- Speed-Wrench feature
- Tools open from both the top and bottom
- Molded-in 90° stop
- Patented spacers between tools



ProGuard™ finish delivers superior corrosion protection

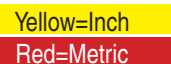

Ball End Tips



Sets	PART#	MODEL#	PCS	CONTENTS	QTY	LIST
Inch	12894	BF5	5	3/16, 7/32, 1/4, 5/16, 3/8"	1	\$15.27
Metric	12897	BF5M	5	5, 6, 7, 8, 10mm	1	\$15.27



TORX® GorillaGrip® Fold Ups

- ProGuard™ Finish -

- Fits all TORX® and Star screws
- World's strongest handle
- Speed-Wrench feature
- Tools open from both the top and bottom
- Molded-in 90° stop
- Patented spacers between tools



Sets	PART#	MODEL#	PCS	CONTENTS	QTY	LIST
TORX®	12632	TF8S	8	T6, T7, T8, T9, T10, T15, T20, T25	1	\$15.01
	12634	TF8	8	T9, T10, T15, T20, T25, T27, T30, T40	1	\$15.37

Tamper Resistant TORX® GorillaGrip® Fold Ups

- ProGuard™ Finish -

- Fits all TORX® and Star tamper resistant screws
- World's strongest handle
- Speed-Wrench feature
- Tools open from both the top and bottom
- Molded-in 90° stop
- Patented spacers between tools



Sets	PART#	MODEL#	PCS	CONTENTS	QTY	LIST
TORX®	12636	TR-TF7S	7	TR7, TR8, TR9, TR10, TR15, TR20, TR25	1	\$15.27
	12638	TR-TF8	8	TR9, TR10, TR15, TR20, TR25, TR27, TR30, TR40	1	\$18.01

Utility GorillaGrip® Fold Ups

- ProGuard™ Finish -

- Wide selection of tool tips
- World's strongest handle
- Speed-Wrench feature
- Tools open from both the top and bottom
- Molded-in 90° stop
- Patented spacers between tools



Sets	PART#	MODEL#	PCS	CONTENTS	QTY	LIST
Utility	12540	HFU5	5	PH #1; Slotted 3/16"; Hex 4, 5, 6mm	1	\$7.97
	12543	RFU5	5	PH #1, #2; Slotted 3/16"; Square #1, #2	1	\$7.97
	12545	AFU5	5	PH #1, #2; Slotted 1/8, 3/16"; Awl	1	\$7.97
	12547	FU5	5	PH #1, #2; Slotted 1/8, 3/16, 1/4"	1	\$7.97

Hawg Buddy GorillaGrip® Motorcycle Fold Up - BriteGuard™ Finish -

- Designed for making all common adjustments to Harley Davidson® motorcycles
- World's strongest handle
- Speed-Wrench feature
- Tools open from both the top and bottom
- Molded-in 90° stop

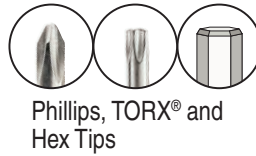

BriteGuard
FINISH

BriteGuard™ finish, next generation chrome



*Harley Davidson® is a Registered Trademark of Harley Davidson Motorcycles

Set	PART#	MODEL#	PCS	CONTENTS	QTY	LIST
	12531	FUHB7	7	PH #2; T27, T40; Hex 5/32, 3/16, 1/4, 5/16"	1	\$25.91

Cycle Buddy GorillaGrip® Motorcycle Fold Up - GoldGuard™ Finish -

- Designed for making all common adjustments to Japanese/European motorcycles
- Fits most ATVs
- World's strongest handle
- Speed-Wrench feature
- Tools open from both the top and bottom
- Molded-in 90° stop



GoldGuard
FINISH

GoldGuard™ finish. Real 14 karat Gold.



Set	PART#	MODEL#	PCS	CONTENTS	QTY	LIST
	12594	FUCB6	6	PH #2; Hex 3, 4, 5, 6, 8mm	1	\$25.91

Metal Fold Ups - ProGuard™ Finish -

- Chamfered tool tips eliminate burrs and help tools seat in screw head
- Sharp corners transfer torque to screw more efficiently and reduce stripping
- Precision machined for ease of use and superior fit



ProGuard
DRY SURFACE TECHNOLOGY
DST

ProGuard™ finish delivers superior corrosion protection



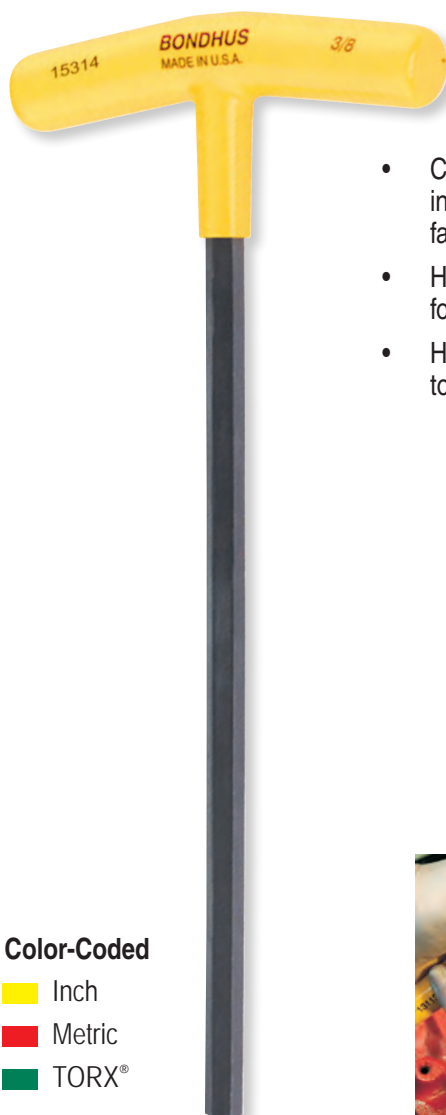

Sets	PART#	MODEL#	PCS	CONTENTS	QTY	LIST
Inch	14590	MHF8	8	.050, 1/16, 5/64, 3/32, 7/64, 1/8, 9/64, 5/32"	1	\$4.71
	14591	MHF9S	9	.050, 1/16, 5/64, 3/32, 7/64, 1/8, 9/64, 5/32, 3/16"	1	\$5.49
	14589	MHF9	9	5/64, 3/32, 7/64, 1/8, 9/64, 5/32, 3/16, 7/32, 1/4"	1	\$6.93
	14585	MHF5	5	3/16, 7/32, 1/4, 5/16, 3/8"	1	\$9.78
Metric	14592	MHF7MS	7	1.5, 2, 2.5, 3, 4, 5, 6mm	1	\$5.69
	14587	MHF7M	7	2, 2.5, 3, 4, 5, 6, 8mm	1	\$7.45
	14595	MHF6M	6	3, 4, 5, 6, 8, 10mm	1	\$10.35
TORX®	14532	MTF8S	8	T6, T7, T8, T9, T10, T15, T20, T25	1	\$13.51
	14534	MTF8	8	T9, T10, T15, T20, T25, T27, T30, T40	1	\$13.51

T-Handles



- Cushioned, curved handle increases comfort and reduces fatigue
- Handle is welded directly to blade for a tool that will last a lifetime
- Handles are designed to match torque capacity of blade

Color-Coded

-  Inch
-  Metric
-  TORX®



High Torque Steel:

Up to 20% stronger, with more torque and twice the wear resistance of standard grades of steel.

FINISH OPTIONS:



Corrosion-resistant finish:

Environmentally safe, provides better tool grip, resists solvents and is 5 times more corrosion resistant than competitor finishes.

A Better T-Handle

Bondhus T-Handles are built to be comfortable, strong and durable. The welded handle and blade joint guarantees a permanent connection. The form-fitting handle fits the curve of the user's hand.

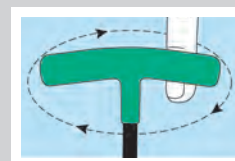

The Bondhus solid steel handle is heavy duty and generates a flywheel effect for super fast insertion and removal of screws.



The Bondhus T-Handle is curved to match the shape of the hand. This design is ergonomically superior to old fashioned straight handles.



Handle and blade are securely welded and will never loosen or slip.



Bondhus is the only company to engineer our handles to match the blade's torque capacity. Tool user's can always feel confident in their tool's strength.

TORX® and TORX PLUS® are trademarks of Acument Intellectual Properties, LLC.

Ball End T-Handles - ProGuard™ Finish -

- Solid steel handles
- Welded handle/blade connection
- Ergonomic handle design
- Flywheel effect saves time
- Smooth, non-porous handle coating
- Handle coating extends along blade

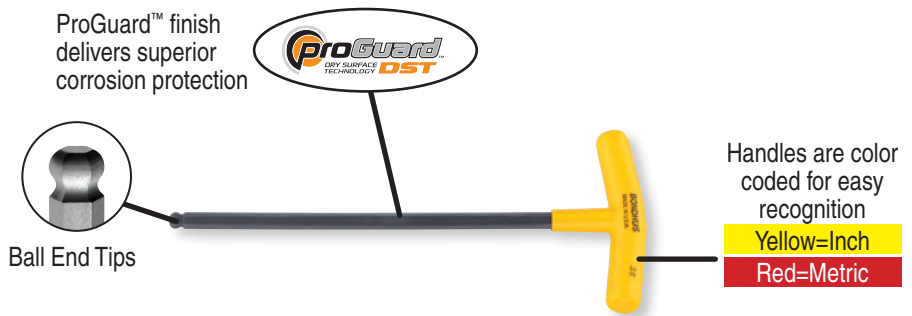

Sets	PART#	MODEL#	PCS	LENGTH	W/STAND	CONTENTS	QTY	LIST
Inch	13146	BTX60	6	Graduated		5/32, 3/16, 7/32, 1/4, 5/16, 3/8"	1	\$42.90
	13190*	BTX10/S	10	Graduated	✓	3/32, 7/64, 1/8, 9/64, 5/32, 3/16, 7/32, 1/4, 5/16, 3/8"	1	\$61.69
	13138*	BTX10	10	Graduated		3/32, 7/64, 1/8, 9/64, 5/32, 3/16, 7/32, 1/4, 5/16, 3/8"	1	\$57.86
Metric	13148	BTX50M	5	Graduated		4, 5, 6, 8, 10mm	1	\$36.85
	13189*	BTX80M/S	8	Graduated	✓	2, 2.5, 3, 4, 5, 6, 8, 10mm	1	\$51.23
	13187*	BTX80M	8	Graduated		2, 2.5, 3, 4, 5, 6, 8, 10mm	1	\$47.40
Inch/Metric	13199*	BTX9IN/MM	9	Graduated		1/8, 5/32, 3/16, 1/4, 5/16" & 3, 4, 5, 6mm	1	\$51.74

*The 3/32, 7/64, 1/8, and 9/64 inch blades, and the 2, 2.5 and 3mm blades are straight hex blades to prevent breakage.
✓ Comes with stand



Singles	SIZE	INCH	MM	INCH	MM	PART#	QTY	LIST EA	PART#	QTY	LIST EA
Inch	3/32	6.1	154	3.0	76	13205 Hex*	2	\$3.93	53205 Hex*	2	\$4.48
	7/64	6.8	173	3.0	76	13206 Hex*	2	\$4.22	53206 Hex*	2	\$4.76
	1/8	7.6	192	3.0	76	13207 Hex*	2	\$4.47	53207 Hex*	2	\$5.11
	9/64	8.3	211	3.0	76	13208 Hex*	2	\$4.74	53208 Hex*	2	\$5.38
	5/32	9.1	231	3.0	76	13109	2	\$5.15	53109	2	\$5.91
	3/16	9.8	250	4.0	102	13110	2	\$5.43	53110	2	\$6.19
	7/32	10.3	262	4.0	102	13111	2	\$6.39	53111	2	\$7.25
	1/4	10.8	275	4.0	102	13112	2	\$6.55	53112	2	\$7.42
	5/16	11.4	289	5.0	127	13113	2	\$10.03	53113	2	\$11.00
	3/8	11.8	300	5.0	127	13114	2	\$11.06	53114	2	\$12.04
Metric	2.0	5.9	150	3.0	76	13252 Hex*	2	\$4.47	53252 Hex*	2	\$5.01
	2.5	6.8	172	3.0	76	13254 Hex*	2	\$4.47	53254 Hex*	2	\$5.01
	3.0	7.7	196	3.0	76	13256 Hex*	2	\$4.74	53256 Hex*	2	\$5.38
	4.0	8.7	220	3.0	76	13160	2	\$5.42	53160	2	\$6.18
	5.0	9.7	246	4.0	102	13164	2	\$6.23	53164	2	\$6.99
	6	10.5	266	4.0	102	13168	2	\$6.77	53168	2	\$7.64
	8	11.2	285	5.0	127	13172	2	\$10.18	53172	2	\$11.16
	10	12.1	307	5.0	127	13176	2	\$11.16	53176	2	\$12.13



*The 3/32, 7/64, 1/8, and 9/64 inch blades, and the 2, 2.5 and 3mm blades are straight hex blades to prevent breakage.

Molded T-Handle Stands

- Extremely durable design
- Can be used free standing or wall mounted
- Sizes are clearly marked on stand
- Available in Inch, Metric, or TORX® configurations

PART#	DESCRIPTION	QTY	LIST EA
17936	Inch Stand	1	\$3.47
17935	Metric Stand	1	\$3.47
17934	TORX® Stand	1	\$3.47



Set stand on bench or mount on wall.

Did you know...?
Welded T-Handle handle/blade connection increases strength and provides greater resistance to breakage. The tool user will never be stabbed in the hand by a blade that has broken free and pushed through the handle.

ProHold® Tip Ball End T-Handles

- ProGuard™ Finish -

- Holds screw tight on the tool EVERY TIME
- Button is non-magnetic
- Super smooth rotational action, with no interference from the ProHold® button
- Tool strength is not compromised by the ProHold® button
- Solid steel handles
- Welded handle/blade connection

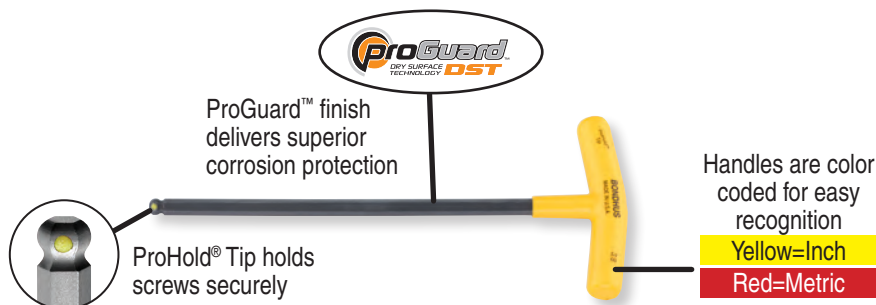

Sets	PART#	MODEL#	PCS	LENGTH	W/STAND	CONTENTS	QTY	LIST
Inch	75146	PBTX60	6	Graduated		5/32, 3/16, 7/32, 1/4, 5/16, 3/8"	1	\$47.82
Metric	75148	PBTX50M	5	Graduated		4, 5, 6, 8, 10mm	1	\$40.88



75148

Singles	SIZE	INCH	MM	INCH	MM	PART#	QTY	LIST EA
Inch	5/32	9.1	231	3.0	76	75109	2	\$5.80
	3/16	9.8	250	4.0	102	75110	2	\$6.19
	7/32	10.3	262	4.0	102	75111	2	\$7.31
	1/4	10.8	275	4.0	102	75112	2	\$7.47
	5/16	11.4	289	5.0	127	75113	2	\$10.85
	3/8	11.8	300	5.0	127	75114	2	\$11.83
Metric	4.0	8.7	220	3.0	76	75160	2	\$6.07
	5.0	9.7	246	4.0	102	75164	2	\$7.06
	6	10.5	266	4.0	102	75168	2	\$7.69
	8	11.2	285	5.0	127	75172	2	\$10.99
	10	12.1	307	5.0	127	75176	2	\$11.95

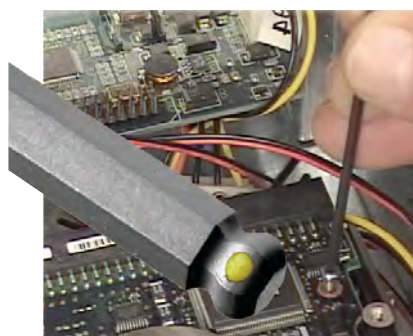
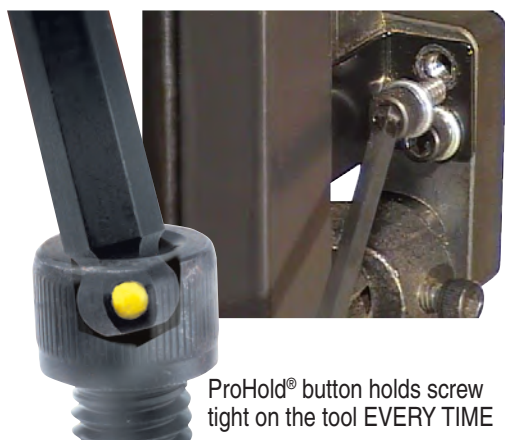

Hex End T-Handle Sets

- ProGuard™ Finish -

T-Handles

- Solid steel handles
- Welded handle/blade connection
- Ergonomic handle design
- Flywheel effect saves time
- Smooth, non-porous handle coating
- Handle coating extends along blade



Sets	PART#	MODEL#	PCS	LENGTH	W/STAND	CONTENTS	QTY	LIST
Inch	13332	HTX80	8	Graduated		3/32, 7/64, 1/8, 9/64, 5/32, 3/16, 7/32, 1/4"	1	\$32.86
	15232	HTX80-6	8	6 inch		3/32, 7/64, 1/8, 9/64, 5/32, 3/16, 7/32, 1/4"	1	\$30.79
	15332	HTX80-9	8	9 inch		3/32, 7/64, 1/8, 9/64, 5/32, 3/16, 7/32, 1/4"	1	\$44.61
	13390	HTX10/S	10	Graduated	✓	3/32, 7/64, 1/8, 9/64, 5/32, 3/16, 7/32, 1/4, 5/16, 3/8"	1	\$52.42
	13338	HTX10	10	Graduated		3/32, 7/64, 1/8, 9/64, 5/32, 3/16, 7/32, 1/4, 5/16, 3/8"	1	\$48.63
	15290	HTX10/S-6	10	6 inch	✓	3/32, 7/64, 1/8, 9/64, 5/32, 3/16, 7/32, 1/4, 5/16, 3/8"	1	\$49.94
	15238	HTX10-6	10	6 inch		3/32, 7/64, 1/8, 9/64, 5/32, 3/16, 7/32, 1/4, 5/16, 3/8"	1	\$46.21
	15390	HTX10/S-9	10	9 inch	✓	3/32, 7/64, 1/8, 9/64, 5/32, 3/16, 7/32, 1/4, 5/16, 3/8"	1	\$69.19
	15338	HTX10-9	10	9 inch		3/32, 7/64, 1/8, 9/64, 5/32, 3/16, 7/32, 1/4, 5/16, 3/8"	1	\$65.52
	Metric	13348	HTX60M	6	Graduated		2, 2.5, 3, 4, 5, 6mm	1
15248		HTX60M-6	6	6 inch		2, 2.5, 3, 4, 5, 6mm	1	\$23.03
15348		HTX60M-9	6	9 inch		2, 2.5, 3, 4, 5, 6mm	1	\$35.03
13389		HTX80M/S	8	Graduated	✓	2, 2.5, 3, 4, 5, 6, 8, 10mm	1	\$48.08
13387		HTX80M	8	Graduated		2, 2.5, 3, 4, 5, 6, 8, 10mm	1	\$44.30
15289		HTX80M/S-6	8	6 inch	✓	2, 2.5, 3, 4, 5, 6, 8, 10mm	1	\$44.61
15287		HTX80M-6	8	6 inch		2, 2.5, 3, 4, 5, 6, 8, 10mm	1	\$40.93
15389		HTX80M/S-9	8	9 inch	✓	2, 2.5, 3, 4, 5, 6, 8, 10mm	1	\$59.87
15387		HTX80M-9	8	9 inch		2, 2.5, 3, 4, 5, 6, 8, 10mm	1	\$56.15
Inch/Metric		15299	HTX9-6IN/MM	9	6 inch		1/8, 5/32, 3/16, 1/4, 5/16" & 3, 4, 5, 6mm	1

✓ Comes with stand 17936 Inch or 17935 Metric



13389



13390



13348

Bondhus



Bondhus handles are permanently welded. There is no chance the blades will ever loosen. The tool user is in no danger of the blade pushing through the top of the handle and stabbing into the palm of the hand.

Competitor



The friction fit blades in competitors' T-Handles are not welded. They can loosen, slip, and even fall out or punch through the top of the handle.



For singles see page 38

Hex End T-Handle Singles

- ProGuard™ Finish -

T-Handles

- Solid steel handles
- Welded handle/blade connection
- Ergonomic handle design
- Flywheel effect saves time
- Smooth, non-porous handle coating
- Handle coating extends along blade



SINGLE PACKAGING

PACKAGED TAGGED/BARCODED

Singles		SIZE	INCH	MM	INCH	MM	PART#	QTY	LIST EA	PART#	QTY	LIST EA
Inch	6" Length											
	5/64	6.0	152	3.0	76	15204	2	\$3.04	45204	2	\$3.58	
	3/32	6.0	152	3.0	76	15205	2	\$3.04	45205	2	\$3.58	
	7/64	6.0	152	3.0	76	15206	2	\$3.11	45206	2	\$3.64	
	1/8	6.0	152	3.0	76	15207	2	\$3.45	45207	2	\$4.10	
	9/64	6.0	152	3.0	76	15208	2	\$3.67	45208	2	\$4.33	
	5/32	6.0	152	3.0	76	15209	2	\$3.86	45209	2	\$4.62	
	3/16	6.0	152	4.0	102	15210	2	\$4.27	45210	2	\$5.03	
	7/32	6.0	152	4.0	102	15211	2	\$4.38	45211	2	\$5.25	
	1/4	6.0	152	4.0	102	15212	2	\$4.98	45212	2	\$5.84	
	5/16	6.0	152	5.0	127	15213	2	\$8.08	45213	2	\$9.06	
	3/8	6.0	152	5.0	127	15214	2	\$9.00	45214	2	\$9.99	
	1/2	6.0	152	5.0	127	15216	1	\$19.09	45216	1	\$20.16	

SINGLE PACKAGING

PACKAGED TAGGED/BARCODED

Singles		SIZE	INCH	MM	INCH	MM	PART#	QTY	LIST EA	PART#	QTY	LIST EA
Metric	6" Length											
	2.0	6.0	152	3.0	76	15252	2	\$3.11	45252	2	\$3.64	
	2.5	6.0	152	3.0	76	15254	2	\$3.11	45254	2	\$3.64	
	3.0	6.0	152	3.0	76	15256	2	\$3.39	45256	2	\$4.05	
	4.0	6.0	152	3.0	76	15260	2	\$3.86	45260	2	\$4.62	
	5.0	6.0	152	4.0	102	15264	2	\$4.22	45264	2	\$4.98	
	6	6.0	152	4.0	102	15268	2	\$5.38	45268	2	\$6.25	
	7	6.0	152	4.0	102	15270	2	\$8.48	-	-	-	
	8	6.0	152	5.0	127	15272	2	\$8.48	45272	2	\$9.45	
	9	6.0	152	5.0	127	15274	2	\$9.41	-	-	-	
	10	6.0	152	5.0	127	15276	2	\$9.41	45276	2	\$10.38	

SINGLE PACKAGING

PACKAGED TAGGED/BARCODED

Singles		SIZE	INCH	MM	INCH	MM	PART#	QTY	LIST EA
Inch	9" Length								
	5/64	9.0	229	3.0	76	15304	2	\$4.61	
	3/32	9.0	229	3.0	76	15305	2	\$4.61	
	7/64	9.0	229	3.0	76	15306	2	\$4.91	
	1/8	9.0	229	3.0	76	15307	2	\$5.21	
	9/64	9.0	229	3.0	76	15308	2	\$5.35	
	5/32	9.0	229	3.0	76	15309	2	\$5.52	
	3/16	9.0	229	4.0	102	15310	2	\$5.62	
	7/32	9.0	229	4.0	102	15311	2	\$6.63	
	1/4	9.0	229	4.0	102	15312	2	\$6.79	
	5/16	9.0	229	5.0	127	15313	2	\$9.92	
	3/8	9.0	229	5.0	127	15314	2	\$10.95	
	1/2	9.0	229	5.0	127	15316	1	\$24.20	
Graduated Length									
	3/32	4.2	105	3.0	76	13305	2	\$3.93	
	7/64	4.4	112	3.0	76	13306	2	\$4.22	
	1/8	4.6	118	3.0	76	13307	2	\$4.35	
	9/64	4.9	124	3.0	76	13308	2	\$4.47	
	5/32	5.2	132	3.0	76	13309	2	\$4.61	
	3/16	5.6	141	4.0	102	13310	2	\$4.74	
	7/32	6.1	154	4.0	102	13311	2	\$5.00	
	1/4	6.5	165	4.0	102	13312	2	\$5.27	
	5/16	7.4	189	5.0	127	13313	2	\$8.57	
3/8	8.3	211	5.0	127	13314	2	\$9.86		

SINGLE PACKAGING

PACKAGED TAGGED/BARCODED

Singles		SIZE	INCH	MM	INCH	MM	PART#	QTY	LIST EA
Metric	9" Length								
	2.0	9.0	229	3.0	76	15352	2	\$5.21	
	2.5	9.0	229	3.0	76	15354	2	\$5.21	
	3.0	9.0	229	3.0	76	15356	2	\$5.52	
	4.0	9.0	229	3.0	76	15360	2	\$5.62	
	5.0	9.0	229	4.0	102	15364	2	\$6.46	
	6	9.0	229	4.0	102	15368	2	\$7.03	
	8	9.0	229	5.0	127	15372	2	\$10.08	
	10	9.0	229	5.0	127	15376	2	\$11.04	
	14" Length								
3.0		14	356	3.0	76	16456	1	\$7.76	
4.0		14	356	3.0	76	16460	1	\$9.21	
5.0		14	356	4.0	102	16464	1	\$9.47	
6		14	356	4.0	102	16468	1	\$11.64	
8	14	356	5.0	127	16472	1	\$12.21		
Graduated Length									
	2.0	4.0	100	3.0	76	13352	2	\$4.47	
	2.5	4.3	110	3.0	76	13354	2	\$4.47	
	3.0	4.7	120	3.0	76	13356	2	\$4.74	
	4.0	5.3	136	3.0	76	13360	2	\$5.14	
	5.0	5.9	150	4.0	102	13364	2	\$5.80	
	6	6.8	173	4.0	102	13368	2	\$6.46	
	8	7.9	202	5.0	127	13372	2	\$9.09	
	10	9.1	232	5.0	127	13376	2	\$10.40	

For sets see page 37

Loop T-Handles

- ProGuard™ Finish -

- Chamfered tool tips eliminate burrs and help tools seat in screw head
- Sharp corners transfer more torque to the screw and reduce stripping
- Precision machined for ease of use and superior fit



ProGuard™ finish delivers superior corrosion protection

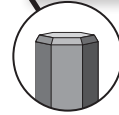

Chamfered Hex Tips fit tighter and eliminate burrs



Sets	PART#	MODEL#	PCS	LENGTH	CONTENTS	QTY	LIST
Inch	15432	LTX80P-6	8	6 inch	3/32, 7/64, 1/8, 9/64, 5/32, 3/16, 7/32, 1/4"	1	\$18.06
	15438	LTX10P-6	10	6 inch	3/32, 7/64, 1/8, 9/64, 5/32, 3/16, 7/32, 1/4, 5/16, 3/8"	1	\$33.79
	15532	LTX80P-9	8	9 inch	3/32, 7/64, 1/8, 9/64, 5/32, 3/16, 7/32, 1/4"	1	\$21.17
	15538	LTX10P-9	10	9 inch	3/32, 7/64, 1/8, 9/64, 5/32, 3/16, 7/32, 1/4, 5/16, 3/8"	1	\$38.55
Metric	15448	LTX50P-6	5	6 inch	2.5, 3, 4, 5, 6mm	1	\$14.49
	15487	LTX80MP-6	8	6 inch	2, 2.5, 3, 4, 5, 6, 8, 10mm	1	\$29.55
	15548	LTX50P-9	5	9 inch	2.5, 3, 4, 5, 6mm	1	\$15.68
	15587	LTX80MP-9	8	9 inch	2, 2.5, 3, 4, 5, 6, 8, 10mm	1	\$32.81



Singles SIZE INCH MM INCH MM PART# QTY LIST EA

Singles SIZE INCH MM INCH MM PART# QTY LIST EA

3" Blade Length

Inch	3/32	3.6	90	2.8	70	15605	2	\$1.23
	7/64	3.6	91	2.8	70	15606	2	\$1.23
	1/8	3.6	92	3.0	76	15607	2	\$1.28
	9/64	3.7	93	3.0	76	15608	2	\$1.40
	5/32	3.7	94	3.0	76	15609	2	\$1.50
	3/16	3.8	95	4.0	102	15610	2	\$1.89
	7/32	3.8	97	4.0	102	15611	2	\$2.55
	1/4	3.9	98	4.0	102	15612	2	\$2.92
	5/16	4.4	111	6.0	152	15613	2	\$5.11
	3/8	4.5	114	6.0	152	15614	2	\$6.22

6" Blade Length

	2.0	6.5	166	2.7	70	15452	2	\$1.81
	2.5	6.6	167	2.7	70	15454	2	\$1.81
	3	6.6	168	3.0	76	15456	2	\$1.81
	4	6.7	170	3.0	76	15460	2	\$2.17
	5	6.8	172	4.0	102	15464	2	\$3.01
	6	6.8	174	4.0	102	15468	2	\$3.56
	8	7.4	187	6.0	152	15472	2	\$6.26
	10	7.5	191	6.0	152	15476	2	\$7.76

6" Blade Length

	3/32	6.6	167	2.8	70	15405	2	\$1.44
	7/64	6.6	167	2.8	70	15406	2	\$1.51
	1/8	6.6	168	3.0	76	15407	2	\$1.51
	9/64	6.7	169	3.0	76	15408	2	\$1.69
	5/32	6.7	170	3.0	76	15409	2	\$1.81
	3/16	6.8	171	4.0	102	15410	2	\$2.23
	7/32	6.8	173	4.0	102	15411	2	\$3.01
	1/4	6.9	175	4.0	102	15412	2	\$3.37
	5/16	7.4	187	6.0	152	15413	2	\$6.15
	3/8	7.5	191	6.0	152	15414	2	\$7.59

9" Blade Length

	2.0	9.5	242	2.8	70	15552	2	\$2.05
	2.5	9.6	243	2.8	70	15554	2	\$2.05
	3	9.6	244	3.0	76	15556	2	\$2.05
	4	9.7	246	3.0	76	15560	2	\$2.41
	5	9.8	248	4.0	102	15564	2	\$3.25
	6	9.8	250	4.0	102	15568	2	\$3.80
	8	10.4	264	6.0	152	15572	2	\$7.05
	10	10.5	268	6.0	152	15576	2	\$9.05

9" Blade Length

	3/32	9.6	243	2.8	70	15505	2	\$1.62
	7/64	9.6	244	2.8	70	15506	2	\$1.69
	1/8	9.6	244	3.0	76	15507	2	\$1.69
	9/64	9.7	245	3.0	76	15508	2	\$1.86
	5/32	9.7	246	3.0	76	15509	2	\$2.05
	3/16	9.8	248	4.0	102	15510	2	\$2.54
	7/32	9.8	249	4.0	102	15511	2	\$3.50
	1/4	9.9	251	4.0	102	15512	2	\$4.10
	5/16	10.4	264	6.0	152	15513	2	\$6.93
	3/8	10.5	267	6.0	152	15514	2	\$8.67



Cushion Grip Loop T-Handles

- ProGuard™ Finish -

- Coated handles for user comfort
- Chamfered tool tips eliminate burrs and help tools seat in screw head
- Sharp corners transfer more torque to the screw and reduce stripping
- Precision machined for ease of use and superior fit

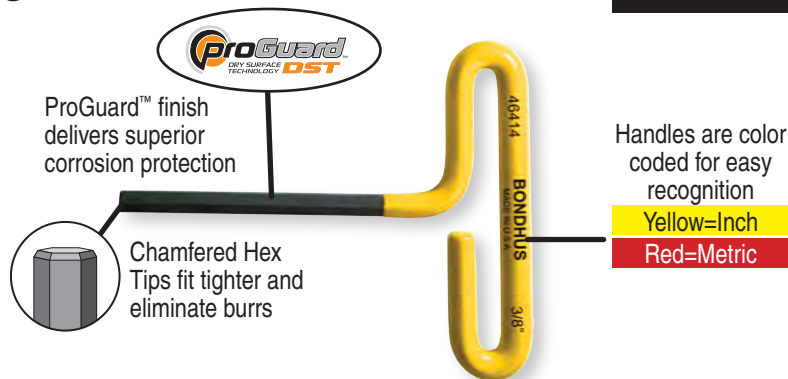

Sets	PART#	MODEL#	PCS	LENGTH	W/STAND	CONTENTS	QTY	LIST
Inch	46432	CTHX80-6	8	6 inch		3/32, 7/64, 1/8, 9/64, 5/32, 3/16, 7/32, 1/4"	1	\$31.85
	46532	CTHX80-9	8	9 inch		3/32, 7/64, 1/8, 9/64, 5/32, 3/16, 7/32, 1/4"	1	\$36.24
	46490	CTHX10/S-6	10	6 inch	✓	3/32, 7/64, 1/8, 9/64, 5/32, 3/16, 7/32, 1/4, 5/16, 3/8"	1	\$50.84
	46438	CTHX10-6	10	6 inch		3/32, 7/64, 1/8, 9/64, 5/32, 3/16, 7/32, 1/4, 5/16, 3/8"	1	\$45.27
	46590	CTHX10/S-9	10	9 inch	✓	3/32, 7/64, 1/8, 9/64, 5/32, 3/16, 7/32, 1/4, 5/16, 3/8"	1	\$56.52
	46538	CTHX10-9	10	9 inch		3/32, 7/64, 1/8, 9/64, 5/32, 3/16, 7/32, 1/4, 5/16, 3/8"	1	\$47.50
Metric	46448	CTHX60M-6	6	6 inch		2, 2.5, 3, 4, 5, 6mm	1	\$26.23
	46548	CTHX60M-9	6	9 inch		2, 2.5, 3, 4, 5, 6mm	1	\$26.98
	46489	CTHX80M/S-6	6	6 inch	✓	2, 2.5, 3, 4, 5, 6, 8, 10mm	1	\$46.39
	46487	CTHX80M-6	8	6 inch		2, 2.5, 3, 4, 5, 6, 8, 10mm	1	\$39.00
	46589	CTHX80M/S-9	8	9 inch	✓	2, 2.5, 3, 4, 5, 6, 8, 10mm	1	\$47.98
	46587	CTHX80M-9	8	9 inch		2, 2.5, 3, 4, 5, 6, 8, 10mm	1	\$42.50

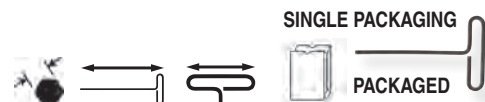

Singles	SIZE	INCH	MM	INCH	MM	PART#	QTY	LIST EA
6" Blade Length								
Inch	5/64	6.6	167	2.8	70	46404	2	\$2.40
	3/32	6.6	167	2.8	70	46405	2	\$2.40
	7/64	6.6	167	2.8	70	46406	2	\$2.46
	1/8	6.6	168	3.0	76	46407	2	\$2.46
	9/64	6.7	169	3.0	76	46408	2	\$2.67
	5/32	6.7	170	3.0	76	46409	2	\$2.79
	3/16	6.8	171	4.0	102	46410	2	\$3.25
	7/32	6.8	173	4.0	102	46411	2	\$4.06
	1/4	6.9	175	4.0	102	46412	2	\$4.66
	5/16	7.4	187	6.0	152	46413	2	\$7.91
3/8	7.5	191	6.0	152	46414	2	\$9.87	
9" Blade Length								
Inch	5/64	9.6	243	2.8	70	46504	2	\$2.57
	3/32	9.6	243	2.8	70	46505	2	\$2.57
	7/64	9.6	244	2.8	70	46506	2	\$2.61
	1/8	9.6	244	3.0	76	46507	2	\$2.61
	9/64	9.7	245	3.0	76	46508	2	\$2.90
	5/32	9.7	246	3.0	76	46509	2	\$3.08
	3/16	9.8	248	4.0	102	46510	2	\$3.64
	7/32	9.8	249	4.0	102	46511	2	\$4.60
	1/4	9.9	251	4.0	102	46512	2	\$5.40
	5/16	10.4	264	6.0	152	46513	2	\$8.74
3/8	10.5	267	6.0	152	46514	2	\$11.07	

Singles	SIZE	INCH	MM	INCH	MM	PART#	QTY	LIST EA	
6" Blade Length									
Metric	2.0	6.5	166	2.7	70	46452	2	\$2.82	
	2.5	6.6	167	2.7	70	46454	2	\$2.82	
	3	6.6	168	3.0	76	46456	2	\$2.82	
	4	6.7	170	3.0	76	46460	2	\$3.21	
	5	6.8	172	4.0	102	46464	2	\$3.95	
	6	6.8	174	4.0	102	46468	2	\$4.66	
	8	7.4	187	6.0	152	46472	2	\$8.01	
	10	7.5	191	6.0	152	46476	2	\$10.23	
	9" Blade Length								
	Metric	2.0	9.5	242	2.8	70	46552	2	\$3.00
2.5		9.6	243	2.8	70	46554	2	\$3.04	
3		9.6	244	3.0	76	46556	2	\$3.08	
4		9.7	246	3.0	76	46560	2	\$3.52	
5		9.8	248	4.0	102	46564	2	\$4.33	
6		9.8	250	4.0	102	46568	2	\$5.15	
8		10.4	264	6.0	152	46572	2	\$8.90	
10		10.5	268	6.0	152	46576	2	\$11.39	

TORX® T-Handles

- ProGuard™ Finish -

- Fits all TORX® and Star screws
- Solid steel handles
- Welded handle/blade connection
- Ergonomic handle design
- Flywheel effect saves time
- Smooth, non-porous handle coating

ProGuard™ finish delivers superior corrosion protection

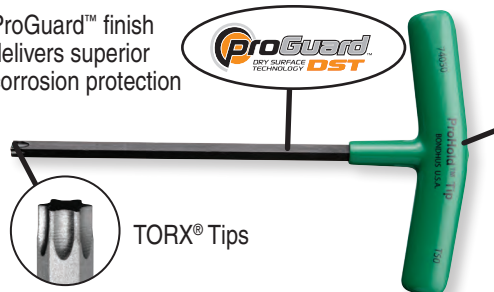

Handles are color coded for easy recognition
Green=TORX®



Set	PART#	MODEL#	PCS	LENGTH	W/STAND	CONTENTS	QTY	LIST
TORX®	33034	TTHX8	8	Graduated	✓	T9, T10, T15, T20, T25, T27, T30, T40	1	\$52.63
✓ Comes with stand 17934								



Singles	SIZE	INCH	MM	INCH	MM	PART#	QTY	LIST EA
TORX®	T9	6.1	155	3.0	76	33009	2	\$5.03
	T10	6.4	161	3.0	76	33010	2	\$5.27
	T15	6.6	168	3.0	76	33015	2	\$5.61
	T20	6.9	174	3.0	76	33020	2	\$5.85
	T25	7.1	180	3.0	76	33025	2	\$6.09
	T27	7.4	187	4.0	102	33027	2	\$6.44
	T30	7.6	193	4.0	102	33030	2	\$6.78
	T40	7.9	199	4.0	102	33040	2	\$7.61
	T45	8.1	206	5.0	127	33045	2	\$8.49
	T50	8.4	212	5.0	127	33050	2	\$9.94
	T55	8.6	218	5.0	127	33055	2	\$12.88

ProHold® TORX® T-Handles

- ProGuard™ Finish -

- Fits all TORX® and Star screws
- Holds screw tight on the tool EVERY TIME
- Button is non-magnetic
- Welded handle/blade connection

ProGuard™ finish delivers superior corrosion protection

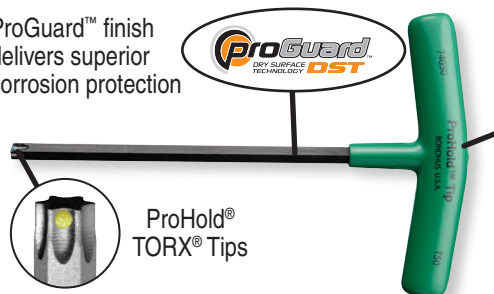

Handles are color coded for easy recognition
Green=TORX®



Set	PART#	MODEL#	PCS	LENGTH	W/STAND	CONTENTS	QTY	LIST
TORX®	74034	PHTTHX8	8	Graduated	✓	T9, T10, T15, T20, T25, T27, T30, T40	1	\$80.52
✓ Comes with stand 17934								



Singles	SIZE	INCH	MM	INCH	MM	PART#	QTY	LIST EA
TORX®	T9	6.1	155	3.0	76	74009	2	\$8.01
	T10	6.4	161	3.0	76	74010	2	\$8.42
	T15	6.6	168	3.0	76	74015	2	\$8.94
	T20	6.9	174	3.0	76	74020	2	\$9.36
	T25	7.1	180	3.0	76	74025	2	\$9.71
	T27	7.4	187	4.0	102	74027	2	\$10.29
	T30	7.6	193	4.0	102	74030	2	\$10.83
	T40	7.9	199	4.0	102	74040	2	\$12.17
	T45	8.1	206	5.0	127	74045	2	\$13.57
	T50	8.4	212	5.0	127	74050	2	\$15.91
	T55	8.6	218	5.0	127	74055	2	\$17.54

Did you know...?
Bondhus T-Handle tools feature an ergonomic handle design to increase user comfort and decrease hand fatigue.

Screwdrivers



- Ergonomic handle design greatly reduces pain and discomfort associated with repetitive tasks
- Non-slip grip generates maximum torque even when wet or oily
- Anti-roll design prevents rolling on vibrating surfaces and inclines up to 15°
- Two component ComfortGrip Handle is durable and comfortable

Color-Coded

- Inch
- Metric
- TORX®



High Torque Steel:

Up to 20% stronger, with more torque and twice the wear resistance of standard grades of steel.

FINISH OPTIONS:



Corrosion-resistant finish:

Environmentally safe, provides better tool grip, resists solvents and is 5 times more corrosion resistant than competitor finishes.



Next generation chrome finish:

Traditional plated tool look with superior protection and durability.



Real 14 karat gold finish:

Superior protection and durability over traditional chrome and the look and shine of real gold.

Attention to Detail

To create a superior screwdriver, Bondhus gives great attention to detail. The ComfortGrip handle is more comfortable and features a better grip than typical screwdrivers. Bondhus is also the only company to match the size of our screwdriver handles to the screwdriver blade's maximum torque.



The Bondhus ComfortGrip handle features a durable thermoplastic core wrapped in cushioned rubber for increased comfort and torque.



Bondhus handles are designed and sized to match the torque capacity of each blade tip.



Ergonomically designed handles deliver maximum torque with unrivaled comfort and grip.



Slight texture of handle helps retain grip, even when hands are wet or oily.

TORX® and TORX PLUS® are trademarks of Acument Intellectual Properties, LLC

Ball End Screwdrivers - ProGuard™ Finish -

- Ball End inserts into screw at a 25° angle
- Ergonomic handle design
- Non-slip grip
- Two component handle with tough inner core and cushioned rubber exterior
- Anti-roll design



Handles are color coded for easy recognition

Yellow=Inch
Red=Metric

Sets	PART#	MODEL#	PCS	LENGTH	CONTENTS	QTY	LIST
Inch	10645	BSX7	7	Standard	5/64, 3/32, 7/64, 1/8, 9/64, 5/32, 3/16"	1	\$23.86
	10632	BSX8S	8	Standard	.050, 1/16, 5/64, 3/32, 7/64, 1/8, 9/64, 5/32"	1	\$24.06
	10633	BSX8	8	Standard	7/64, 1/8, 9/64, 5/32, 3/16, 7/32, 1/4, 5/16"	1	\$39.07
	10637	BSX13	13	Standard	.050, 1/16, 5/64, 3/32, 7/64, 1/8, 9/64, 5/32, 3/16, 7/32, 1/4, 5/16, 3/8"	1	\$57.91
	10737	BSX11L	11	Long	5/64, 3/32, 7/64, 1/8, 9/64, 5/32, 3/16, 7/32, 1/4, 5/16, 3/8"	1	\$63.65
Metric	10686	BSX6M	6	Standard	1.5, 2, 2.5, 3, 4, 5mm	1	\$20.75
	10687	BSX7M	7	Standard	1.27, 1.5, 2, 2.5, 3, 4, 5mm	1	\$23.13
	10699	BSX9M	9	Standard	1.5, 2, 2.5, 3, 4, 5, 6, 8, 10mm	1	\$45.64
	10733	BSX8ML	8	Long	2, 2.5, 3, 4, 5, 6, 8, 10mm	1	\$52.06



10637

Singles	Standard					Long														
	SIZE	INCH	MM	INCH	MM	PART#	QTY	LIST	EA	PART#	QTY	LIST	EA							
Inch	Standard					Long														
	.050	2.4	60	4.1	104	10602	2	\$2.37		40602	2	\$2.91								
	1/16	2.5	64	4.7	118	10603	2	\$2.56		40603	2	\$3.12								
	5/64	2.6	67	4.8	122	10604	2	\$2.77		40604	2	\$3.31	5/64	4.3	110	6.5	164	10704	2	\$3.22
	3/32	2.8	71	5.2	132	10605	2	\$2.91		40605	2	\$3.46	3/32	4.8	122	7.2	184	10705	2	\$3.33
	7/64	2.9	74	5.3	136	10606	2	\$2.94		40606	2	\$3.48	7/64	5.9	151	8.4	212	10706	2	\$3.66
	1/8	3.1	80	6.6	168	10607	2	\$2.98		40607	2	\$3.63	1/8	6.4	164	9.9	252	10707	2	\$3.98
	9/64	3.3	83	6.8	171	10608	2	\$3.25		40608	2	\$3.89	9/64	6.9	176	10.4	264	10708	2	\$4.31
	5/32	3.6	91	7.9	201	10609	2	\$3.47		40609	2	\$4.12	5/32	7.4	189	11.8	299	10709	2	\$5.14
	3/16	3.7	94	8.0	204	10610	2	\$4.61		40610	2	\$5.36	3/16	7.9	202	12.3	312	10710	2	\$5.71
	7/32	4.2	107	9.0	230	10611	2	\$4.95		40611	2	\$5.69	7/32	8.4	214	13.3	337	10711	2	\$6.39
	1/4	5.0	126	9.8	249	10612	2	\$6.26		40612	2	\$7.12	1/4	8.9	227	13.7	349	10712	2	\$7.43
	5/16	5.6	142	10.4	265	10613	2	\$7.42		40613	2	\$8.39	5/16	9.5	241	14.3	364	10713	2	\$8.87
3/8	6.5	164	11.3	287	10614	2	\$8.91		40614	2	\$9.88	3/8	9.9	252	14.8	376	10714	2	\$10.51	
7/16	7.6	194	12.5	317	10615	1	\$18.52		-	-	-	-	-	-	-	-	-	-		
1/2	8.6	217	13.4	340	10616	1	\$21.72		-	-	-	-	-	-	-	-	-	-		
Metric	Standard					Long														
	1.27	2.4	60	4.1	104	10649	2	\$2.36		40649	2	\$2.90	-	-	-	-	-	-	-	
	1.5	2.6	66	4.7	120	10650	2	\$2.64		40650	2	\$3.18	-	-	-	-	-	-	-	
	2.0	2.8	72	5.0	127	10652	2	\$2.94		40652	2	\$3.48	2.0	4.0	102	6.2	157	10752	2	\$3.31
	2.5	2.7	69	5.1	130	10654	2	\$2.95		40654	2	\$3.51	2.5	4.3	110	6.7	171	10754	2	\$3.55
	3.0	3.3	83	6.7	171	10656	2	\$2.99		40656	2	\$3.54	3.0	6.2	158	9.7	247	10756	2	\$4.18
	3.5	3.5	88	6.9	176	10658	1	\$4.07		-	-	-	-	-	-	-	-	-	-	
	4.0	3.7	95	8.1	205	10660	2	\$3.61		40660	2	\$4.26	4.0	7.0	179	11.4	288	10760	2	\$4.52
	4.5	4.3	109	8.6	218	10662	1	\$4.98		-	-	-	-	-	-	-	-	-	-	
	5.0	4.3	109	8.6	219	10664	2	\$4.76		40664	2	\$5.52	5.0	7.8	198	12.1	308	10764	2	\$6.18
	5.5	5.0	126	9.3	236	10666	1	\$6.93		-	-	-	-	-	-	-	-	-	-	
	6	5.4	137	10.2	260	10668	2	\$5.45		40668	2	\$6.31	6	8.6	218	13.4	341	10768	2	\$6.60
	7	5.7	145	10.5	268	10670	1	\$8.52		-	-	-	-	-	-	-	-	-	-	
8	6.4	162	11.2	286	10672	2	\$8.30		40672	2	\$9.27	8	9.3	237	14.2	360	10772	2	\$9.15	
9	6.9	175	11.7	298	10674	1	\$11.12		-	-	-	-	-	-	-	-	-	-		
10	7.3	184	12.1	307	10676	2	\$9.58		40676	2	\$10.56	10	10.2	259	15.0	382	10776	2	\$11.28	

For Extra Long Length Singles see page 44

Ball End Screwdriver Extra Long

- ProGuard™ Finish -

- Ball End inserts into screw at a 25° angle
- Ergonomic handle design
- Non-slip grip



Ball End Tips

ProGuard™ finish delivers superior corrosion protection



Handles are color coded for easy recognition

Yellow=Inch

Red=Metric



Singles	SIZE	INCH	MM	INCH	MM	PART#	QTY	LIST EA
Extra Long								
Inch	.050	11.1	283	12.8	326	3702	1	\$8.71
	1/16	11.1	281	13.2	336	3703	1	\$8.71
	5/64	11.0	279	13.2	334	3704	1	\$8.71
	3/32	11.0	279	13.4	341	3705	1	\$8.71
	7/64	10.6	270	13.0	331	3706	1	\$8.60
	1/8	10.6	270	14.1	358	3707	1	\$8.60
	9/64	10.5	267	14.0	355	3708	1	\$9.05
	5/32	10.5	267	14.8	377	3709	1	\$9.28
	3/16	10.3	260	14.6	370	3710	1	\$10.19
	7/32	10.3	260	15.1	383	3711	1	\$10.19
	1/4	10.3	260	15.1	383	3712	1	\$10.93
	5/16	10.3	260	15.1	383	3713	1	\$11.93
	3/8	10.3	260	15.1	383	3714	1	\$13.90
	7/16	10.5	267	15.3	390	3715	1	\$15.07
1/2	10.5	267	15.3	390	3716	1	\$16.83	

Singles	SIZE	INCH	MM	INCH	MM	PART#	QTY	LIST EA
Extra Long								
Metric	1.5	11.0	279	13.2	334	3750	1	\$8.71
	2.0	11.0	279	13.2	334	3752	1	\$8.71
	2.5	10.5	267	12.9	328	3754	1	\$8.71
	3.0	10.6	270	14.1	358	3756	1	\$8.60
	4.0	10.5	267	14.8	377	3760	1	\$9.28
	5.0	10.3	260	14.6	370	3764	1	\$10.19
	6	10.3	260	15.1	383	3768	1	\$10.93
	8	10.3	260	15.1	383	3772	1	\$11.93
	10	10.3	260	15.1	383	3776	1	\$13.90

ProHold® Ball End Screwdrivers

- ProGuard™ Finish -

- Holds screw tight on the tool EVERY TIME
- Button is non-magnetic
- Super smooth rotational action, with no interference from the ProHold® button

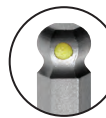

ProHold® Tip holds screws securely

ProGuard™ finish delivers superior corrosion protection



Handles are color coded for easy recognition

Yellow=Inch

Red=Metric

Sets	PART#	MODEL#	PCS	CONTENTS	QTY	LIST
Inch	74632	PBSX8S	8	.050, 1/16, 5/64, 3/32, 7/64, 1/8, 9/64, 5/32"	1	\$28.57
	74637	PBSX13	13	.050, 1/16, 5/64, 3/32, 7/64, 1/8, 9/64, 5/32, 3/16, 7/32, 1/4, 5/16, 3/8"	1	\$66.71
Metric	74686	PBSX6M	6	1.5, 2, 2.5, 3, 4, 5mm	1	\$24.22
	74699	PBSX9M	9	1.5, 2, 2.5, 3, 4, 5, 6, 8, 10mm	1	\$51.75



Singles	SIZE	INCH	MM	INCH	MM	PART#	QTY	LIST EA
Inch	.050	2.4	60	4.1	104	74602	2	\$2.89
	1/16	2.5	64	4.7	118	74603	2	\$3.07
	5/64	2.6	67	4.8	122	74604	2	\$3.27
	3/32	2.8	71	5.2	132	74605	2	\$3.43
	7/64	2.9	74	5.3	136	74606	2	\$3.54
	1/8	3.1	80	6.6	168	74607	2	\$3.61
	9/64	3.3	83	6.8	171	74608	2	\$3.87
	5/32	3.6	91	7.9	201	74609	2	\$4.10
	3/16	3.7	94	8.0	204	74610	2	\$5.31
	7/32	4.2	107	9.0	230	74611	2	\$5.82
	1/4	4.7	118	9.8	249	74612	2	\$7.07
	5/16	5.6	142	10.4	265	74613	2	\$8.18
	3/8	6.5	164	11.3	287	74614	2	\$9.59

Singles	SIZE	INCH	MM	INCH	MM	PART#	QTY	LIST EA
Metric	1.27	2.4	60	4.1	104	74649	2	\$2.89
	1.5	2.6	66	4.7	120	74650	2	\$3.14
	2.0	2.8	72	5.0	127	74652	2	\$3.43
	2.5	2.7	69	5.1	130	74654	2	\$3.47
	3.0	3.3	83	6.7	171	74656	2	\$3.60
	4.0	3.7	95	8.1	205	74660	2	\$4.25
	5.0	4.3	109	8.6	219	74664	2	\$5.54
	6	5.4	137	10.2	260	74668	2	\$6.29
	8	6.4	162	11.2	286	74672	2	\$8.99
	10	7.3	184	12.1	307	74676	2	\$10.23

Ball End Screwdrivers - BriteGuard™ Finish -

- Ball End inserts into screw at a 25° angle
- Ergonomic handle design
- Non-slip grip
- Two component handle with tough inner core and cushioned rubber exterior
- Anti-roll design



BriteGuard™ finish delivers superior corrosion protection



Ball End Tips

Handles are color coded for easy recognition

Yellow=Inch
Red=Metric

Sets	PART#	MODEL#	PCS	CONTENTS	QTY	LIST
Inch	16632	BSX8SB	8	.050, 1/16, 5/64, 3/32, 7/64, 1/8, 9/64, 5/32"	1	\$34.18
	16637	BSX13B	13	.050, 1/16, 5/64, 3/32, 7/64, 1/8, 9/64, 5/32, 3/16, 7/32, 1/4, 5/16, 3/8"	1	\$82.70
Metric	16686	BSX6MB	6	1.5, 2, 2.5, 3, 4, 5mm	1	\$31.63
	16699	BSX9MB	9	1.5, 2, 2.5, 3, 4, 5, 6, 8, 10mm	1	\$68.25

SINGLE PACKAGING



PACKAGED

SINGLE PACKAGING

PACKAGED

Singles	SIZE	INCH	MM	INCH	MM	PART#	QTY	LIST EA
Inch	.050	2.4	60	4.1	104	16602	2	\$3.61
	1/16	2.5	64	4.7	118	16603	2	\$3.94
	5/64	2.6	67	4.8	122	16604	2	\$4.46
	3/32	2.8	71	5.2	132	16605	2	\$4.46
	7/64	2.9	74	5.3	136	16606	2	\$4.61
	1/8	3.1	80	6.6	168	16607	2	\$4.61
	9/64	3.3	83	6.8	171	16608	2	\$5.53
	5/32	3.6	91	7.9	201	16609	2	\$5.53
	3/16	3.7	94	8.0	204	16610	2	\$7.22
	7/32	4.2	107	9.0	230	16611	2	\$8.26
	1/4	5.0	126	9.8	249	16612	2	\$8.26
	5/16	5.6	142	10.4	265	16613	2	\$12.61
	3/8	6.5	164	11.3	287	16614	2	\$14.56
	7/16	7.6	194	12.5	317	16615	1	\$26.40
	1/2	8.6	217	13.4	340	16616	1	\$30.87

Singles	SIZE	INCH	MM	INCH	MM	PART#	QTY	LIST EA
Metric	1.27	2.4	60	4.1	104	16649	2	\$3.61
	1.5	2.6	66	4.7	120	16650	2	\$3.94
	2.0	2.8	72	5.0	127	16652	2	\$4.46
	2.5	2.7	69	5.1	130	16654	2	\$4.46
	3.0	3.3	83	6.7	171	16656	2	\$4.61
	4.0	3.7	95	8.1	205	16660	2	\$5.52
	5.0	4.3	109	8.6	219	16664	2	\$7.22
	6	5.4	137	10.2	260	16668	2	\$8.26
	8	6.4	162	11.2	286	16672	2	\$12.61
	10	7.3	184	12.1	307	16676	2	\$14.56

Ball End Screwdrivers - GoldGuard™ Finish -

- Ball End inserts into screw at a 25° angle
- Ergonomic handle design
- Non-slip grip
- Two component handle with tough inner core and cushioned rubber exterior
- Anti-roll design



GoldGuard™ finish. Real 14 karat Gold



Ball End Tips

Handles are color coded for easy recognition

Yellow=Inch
Red=Metric

Sets	PART#	MODEL#	PCS	CONTENTS	QTY	LIST
Inch	38632	BSX8SG	8	.050, 1/16, 5/64, 3/32, 7/64, 1/8, 9/64, 5/32"	1	\$35.15
	38637	BSX13G	13	.050, 1/16, 5/64, 3/32, 7/64, 1/8, 9/64, 5/32, 3/16, 7/32, 1/4, 5/16, 3/8"	1	\$85.09
Metric	38686	BSX6MG	6	1.5, 2, 2.5, 3, 4, 5mm	1	\$32.50
	38699	BSX9MG	9	1.5, 2, 2.5, 3, 4, 5, 6, 8, 10mm	1	\$70.20

SINGLE PACKAGING



PACKAGED

SINGLE PACKAGING

PACKAGED

Singles	SIZE	INCH	MM	INCH	MM	PART#	QTY	LIST EA
Inch	.050	2.4	60	4.1	104	38602	2	\$3.70
	1/16	2.5	64	4.7	118	38603	2	\$4.04
	5/64	2.6	67	4.8	122	38604	2	\$4.60
	3/32	2.8	71	5.2	132	38605	2	\$4.60
	7/64	2.9	74	5.3	136	38606	2	\$4.74
	1/8	3.1	80	6.6	168	38607	2	\$4.74
	9/64	3.3	83	6.8	171	38608	2	\$5.68
	5/32	3.6	91	7.9	201	38609	2	\$5.68
	3/16	3.7	94	8.0	204	38610	2	\$7.44
	7/32	4.2	107	9.0	230	38611	2	\$8.49
	1/4	5.0	126	9.8	249	38612	2	\$8.49
	5/16	5.6	142	10.4	265	38613	2	\$12.99
	3/8	6.5	164	11.3	287	38614	2	\$14.98
	7/16	7.6	194	12.5	317	38615	1	\$27.15
	1/2	8.6	217	13.4	340	38616	1	\$31.74

Singles	SIZE	INCH	MM	INCH	MM	PART#	QTY	LIST EA
Metric	1.27	2.4	60	4.1	104	38649	2	\$3.70
	1.5	2.6	66	4.7	120	38650	2	\$4.04
	2.0	2.8	72	5.0	127	38652	2	\$4.60
	2.5	2.7	69	5.1	130	38654	2	\$4.60
	3.0	3.3	83	6.8	172	38656	2	\$4.74
	4.0	3.7	95	8.1	205	38660	2	\$5.68
	5.0	4.3	109	8.6	219	38664	2	\$7.44
	6	5.4	137	10.2	260	38668	2	\$8.49
	8	6.4	162	11.2	286	38672	2	\$12.99
	10	7.3	184	12.1	307	38676	2	\$14.98

TORX® Tip Screwdrivers

- ProGuard™ Finish -

- Fits all TORX® and Star screws
- Burr free tool tips help tools seat fully in screw head
- Precision machined tips transfer more torque to the screw and reduces stripping
- Broad contact surface provides deep lobe engagement
- Straight, vertical sidewalls increase tool engagement and virtually eliminates camout

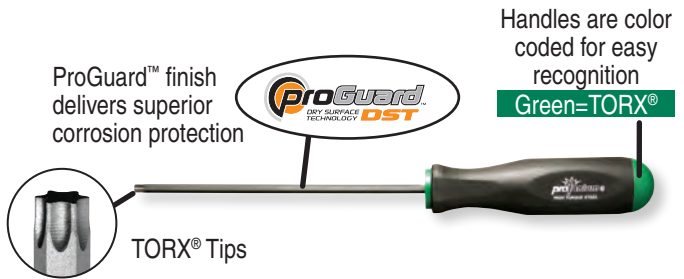

Sets	PART#	MODEL#	PCS	CONTENTS	QTY	LIST
TORX®	34532	TSX8S	8	T6, T7, T8, T9, T10, T15, T20, T25	1	\$40.26
	34534	TSX8	8	T9, T10, T15, T20, T25, T27, T30, T40	1	\$46.78

SINGLE PACKAGING



Singles	SIZE	INCH	MM	INCH	MM	PART#	QTY	LIST EA
TORX®	T5	4.0	102	6.2	156	34505	2	\$5.85
	T6	4.3	108	6.4	163	34506	2	\$4.56
	T7	4.5	114	6.7	169	34507	2	\$4.44
	T8	4.8	121	7.2	182	34508	2	\$4.44
	T9	4.9	124	7.3	186	34509	2	\$4.79
	T10	5.0	128	7.4	189	34510	2	\$5.03
	T15	5.1	131	8.6	219	34515	2	\$5.14
	T20	5.4	138	9.8	248	34520	2	\$5.61
	T25	5.7	144	10.0	253	34525	2	\$6.20
	T27	5.8	147	10.6	270	34527	2	\$7.13
	T30	6.0	153	10.9	276	34530	2	\$8.42
	T40	6.3	159	11.1	282	34540	2	\$9.18
	T45	6.5	166	11.4	289	34545	1	\$9.26
	T50	6.8	172	11.6	295	34550	1	\$10.28
	T55	7.0	178	11.9	301	34555	1	\$11.46
	T60	7.3	185	12.1	308	34560	1	\$13.11

Did you know...?
ProGuard™ Dry Surface Technology is the world's best corrosion protection. The tool user does not have to work with rusty tools. ProGuard™ protection delivers up to 5 times the corrosion resistance of any other Hex or TORX® tool finish.

ProHold® TORX® Screwdrivers

- ProGuard™ Finish -

- Fits all TORX® and Star screws
- Holds screw tight on the tool EVERY TIME
- Button is non-magnetic
- Broad contact surface provides deep lobe engagement

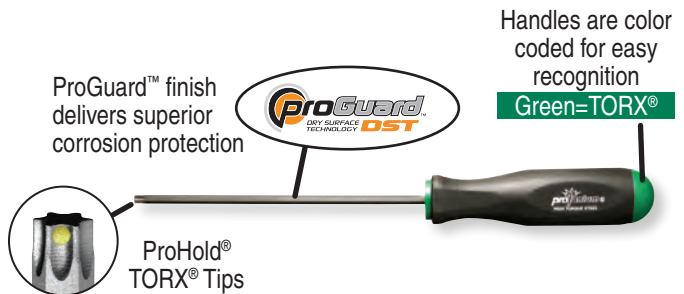

Sets	PART#	MODEL#	PCS	CONTENTS	QTY	LIST
TORX®	75534	PHTSX8	8	T9, T10, T15, T20, T25, T27, T30, T40	1	\$81.87

SINGLE PACKAGING



Singles	SIZE	INCH	MM	INCH	MM	PART#	QTY	LIST EA
TORX®	T9	4.9	124	7.3	186	75509	1	\$7.62
	T10	5.0	128	7.4	189	75510	1	\$7.95
	T15	5.1	131	8.6	219	75515	1	\$8.18
	T20	5.4	138	9.8	248	75520	1	\$8.89
	T25	5.7	144	10.0	253	75525	1	\$9.82
	T27	5.8	147	10.6	270	75527	1	\$11.34
	T30	6.0	153	10.9	276	75530	1	\$13.46
	T40	6.3	159	11.1	282	75540	1	\$14.62
	T45	6.5	166	11.4	289	75545	1	\$15.20
	T50	6.8	172	11.6	295	75550	1	\$16.97
	T55	7.0	178	11.9	301	75555	1	\$18.95
	T60	7.3	185	12.1	308	75560	1	\$20.94

Did you know...?
ProHold® buttons are non-magnetic and work on all fastener types. They are safe to use on sensitive equipment. They will not rust and will hold non-magnetic screws (aluminum, stainless and plastic).

BallStar™ Tip Screwdrivers

- ProGuard™ Finish -

- Fits all TORX® and Star screws
- Ball End inserts into a screw at a 20° angle
- Ball End saves time by quickly funneling tool into screw
- Superior Ball End strength and working angle
- Works in hard to reach places



ProGuard™ finish delivers superior corrosion protection



Handles are color coded for easy recognition
Green=TORX®

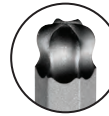

BallStar™ Tips

Sets	PART#	MODEL#	PCS	CONTENTS	QTY	LIST
BALL STAR™	13546	STX6	6	T6, T7, T8, T9, T10, T15	1	\$44.51
	13532	STX8	8	T9, T10, T15, T20, T25, T27, T30, T40	1	\$66.03

SINGLE PACKAGING



PACKAGED

Singles	SIZE	INCH	MM	INCH	MM	PART#	QTY	LIST EA
BALL STAR™	T6	2.6	65	4.7	119	12706	2	\$7.29
	T7	2.6	65	4.7	119	12707	2	\$7.29
	T8	2.6	65	5.0	126	12708	2	\$7.29
	T9	2.6	65	5.0	126	12709	2	\$7.29
	T10	2.8	70	5.2	132	12710	2	\$7.69
	T15	2.9	73	6.4	161	12715	2	\$7.69
	T20	3.2	81	7.5	191	12720	2	\$7.90
	T25	3.4	87	7.7	197	12725	2	\$8.11
	T27	3.8	97	8.7	220	12727	2	\$8.54
	T30	4.2	106	9.0	229	12730	2	\$9.11
	T40	4.6	117	9.4	240	12740	2	\$9.74
	T45	5.2	132	10.0	255	12745	1	\$11.55
	T50	6.0	153	10.9	276	12750	1	\$13.78
	T55	6.8	172	11.6	295	12755	1	\$16.55

Did you know...?
BallStar™ tools work at a 20° angle; screws can be turned continuously without constantly taking the tool out of the screw, repositioning it and reinserting it, even at angles up to 20°.

Tamper Resistant TORX® Screwdrivers

- ProGuard™ Finish -

- Fits all TORX® and Star tamper resistant screws
- Burr free tool tips help tools seat fully in screw head
- Precision machined tips transfer more torque to the screw and reduces stripping

ProGuard™ finish delivers superior corrosion protection



Handles are color coded for easy recognition
Green=TORX®

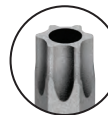

Tamper Resistant TORX® Tips

Sets	PART#	MODEL#	PCS	CONTENTS	QTY	LIST
TORX®	33832	TR-SX8S	8	TR6, TR7, TR8, TR9, TR10, TR15, TR20, TR25	1	\$66.65
	33834	TR-SX8	8	TR9, TR10, TR15, TR20, TR25, TR27, TR30, TR40	1	\$85.39

SINGLE PACKAGING



PACKAGED

Singles	SIZE	INCH	MM	INCH	MM	PART#	QTY	LIST EA
TORX®	TR6	4.3	108	6.4	163	33806	1	\$7.62
	TR7	4.5	114	6.7	169	33807	1	\$7.62
	TR8	4.8	121	7.2	182	33808	1	\$7.62
	TR9	4.9	124	7.3	186	33809	1	\$7.85
	TR10	5.0	128	7.4	189	33810	1	\$7.85
	TR15	5.1	131	8.6	219	33815	1	\$8.01
	TR20	5.4	138	9.8	248	33820	1	\$10.06
	TR25	5.7	144	10.0	253	33825	1	\$10.12
	TR27	5.8	147	10.6	270	33827	1	\$12.00
	TR30	6.0	153	10.9	276	33830	1	\$14.33
	TR40	6.3	159	11.1	282	33840	1	\$15.49

Did you know...?
Bondhus' ergonomic handle design greatly reduces fatigue associated with repetitive tasks and the application of torque.



All Bondhus® tools are made with Protanium® High Torque Steel.

TORX® and TORX PLUS® are registered trademarks of Acument Intellectual Properties, LLC.

Made in the U.S.A.

Square Ball End Screwdrivers

- ProGuard™ Finish -

- Ball End inserts into a screw at a 25° angle
- Ball End saves time by quickly funneling tool into screw
- Two component handle with tough inner core and cushioned rubber exterior
- Non-slip grip
- Anti-roll design



ProGuard™ finish delivers superior corrosion protection

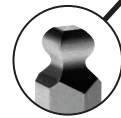

Square Ball Tips

Ergonomic handle design



Set	PART#	MODEL#	PCS	CONTENTS	QTY	LIST
	11640	BRX4	4	SQ0, SQ1, SQ2, SQ3	1	\$22.61



Singles	SIZE	INCH	MM	INCH	MM	PART#	QTY	LIST EA
	SQ0	3.5	90	7.0	178	11600	2	\$4.89
	SQ1	3.8	95	7.2	183	11601	2	\$5.59
	SQ2	4.0	102	8.3	212	11602	2	\$6.00
	SQ3	4.0	102	8.3	212	11603	2	\$6.68
	SQ4	4.5	115	8.8	225	11604	2	\$7.42

Bondhex™ Cases

- Provides a convenient means of keeping L-Wrenches neat and organized
- Sizes are printed on the case for quick tool selection
- Case can be used in conjunction with the tool to increase torque

	PART#	FITS SIZES	QTY	LIST
Inch	18032	.050, 1/16, 5/64, 3/32, 7/64, 1/8, 9/64, 5/32"	10	\$1.04
	18036	.050, 1/16, 5/64, 3/32, 7/64, 1/8, 9/64, 5/32, 3/16, 7/32, 1/4, 5/16"	10	\$1.29
	18037	.050, 1/16, 5/64, 3/32, 7/64, 1/8, 9/64, 5/32, 3/16, 7/32, 1/4, 5/16, 3/8"	10	\$1.55
	18038	1/16, 5/64, 3/32, 7/64, 1/8, 9/64, 5/32, 3/16, 7/32, 1/4"	10	\$1.29
	18045	5/64, 3/32, 7/64, 1/8, 9/64, 5/32, 3/16"	10	\$1.04
Metric	18046	1.5, 2, 2.5, 3, 4, 5mm	10	\$1.04
	18099	1.5, 2, 2.5, 3, 4, 5, 6, 8, 10mm	10	\$1.29

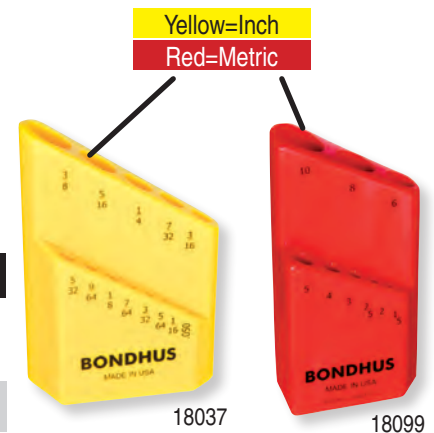

About the Bondhex™ Case

For Ball End and Hex Tip L-Wrenches

Bondhus Ball End and Hex key sets are packed in a color-coded Bondhex™ case to keep tools neat and sorted. A simple 60 degree turn locks keys in place to eliminate loose, spilled and lost keys. Tool sizes are clearly printed beneath each tool for quick size selection. A Bondhex™ case can also be used with a hex key to increase grip and comfortably generate additional torque.

Most Bondhus L-Wrench sets come standard with our Bondhex™ case.



Hollow Shaft Nut Drivers

- Hexagonal upper shaft for use with a wrench for increased torque
- Ergonomic handle design
- Non-slip grip
- Anti-roll handle
- High strength chrome plated shaft



Handles are color coded for easy recognition
Yellow=Inch
Red=Metric

Sets	PART#	MODEL#	PCS	CONTENTS	QTY	LIST
Inch	48445	BNX7	7	3/16, 1/4, 5/16, 11/32, 3/8, 7/16, 1/2"	1	\$37.88
Metric	48492	BNX7M	7	6, 7, 8, 9, 10, 11, 12mm	1	\$37.88
	48496	BNX7ML	7	6, 7, 8, 9, 10, 11, 13mm	1	\$37.88

SINGLE PACKAGING



Singles	SIZE	INCH		MM		PACKAGED			TAGGED/BARCODED		
		INCH	MM	INCH	MM	PART#	QTY	LIST EA	PART#	QTY	LIST EA
Inch	5/32	3	76	7.3	186	38409	1	\$6.37	48409	1	\$7.04
	3/16	3	76	7.3	186	38410	1	\$6.37	48410	1	\$7.04
	7/32	3	76	7.3	186	38411	1	\$6.37	48411	1	\$7.04
	1/4	3	76	7.3	186	38412	1	\$6.37	48412	1	\$7.04
	9/32	3	76	7.3	186	38432	1	\$6.57	48432	1	\$7.25
	5/16	3	76	7.3	186	38413	1	\$6.57	48413	1	\$7.25
	11/32	3	76	7.3	186	38435	1	\$6.57	48435	1	\$7.25
	3/8	3	76	7.3	186	38414	1	\$7.25	48414	1	\$7.92
	7/16	3	76	7.3	186	38415	1	\$7.25	48415	1	\$7.92
	1/2	3	76	7.3	186	38416	1	\$7.25	48416	1	\$7.92
Metric	4.0	3	76	7.3	186	38460	1	\$6.37	48460	1	\$7.04
	5.0	3	76	7.3	186	38464	1	\$6.37	48464	1	\$7.04
	5.5	3	76	7.3	186	38466	1	\$6.37	48466	1	\$7.04
	6	3	76	7.3	186	38468	1	\$6.37	48468	1	\$7.04
	7	3	76	7.3	186	38470	1	\$6.57	48470	1	\$7.25
	8	3	76	7.3	186	38472	1	\$6.57	48472	1	\$7.25
	9	3	76	7.3	186	38474	1	\$6.57	48474	1	\$7.25
	10	3	76	7.3	186	38476	1	\$7.25	48476	1	\$7.92
	11	3	76	7.3	186	38478	1	\$7.25	48478	1	\$7.92
	12	3	76	7.3	186	38480	1	\$7.25	48480	1	\$7.92
	13	3	76	7.3	186	38482	1	\$7.25	48482	1	\$7.92



48492



ClickSet™ TLD (Torque Limiting Device)



- Wide range of factory preset torque limiting handles – no adjustment needed
- When the preset torque level is reached, the mechanism slips and makes an audible “click”
- Protects from overtorquing
- Reduces fastener wear and stripping
- Reduces potential damage to carbide inserts
- +/- 10% repeatability

Factory preset torque value

Economical solution to an expensive problem

Factory preset torque level helps prevent damage to carbide inserts.

Perfect for use with aluminum and plastic screws.



High Torque Steel:

Up to 20% stronger, with more torque and twice the wear resistance of standard grades of steel.

FINISH OPTION:



Impermeable polymer surface:

Impermeable PTFE (with TEFLON®* material) added to finish for extra corrosion protection. Environmentally friendly finish, free of harsh chemicals, acids, and metals.

Dependable Economy

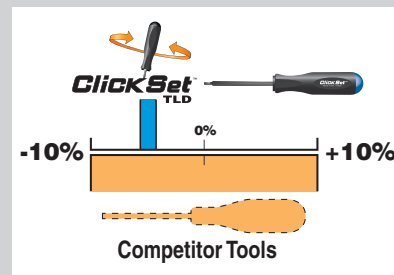

A Bondhus ClickSet™ TLD tool will deliver the same torque every time. Competitor tools deliver a different torque level with every use.

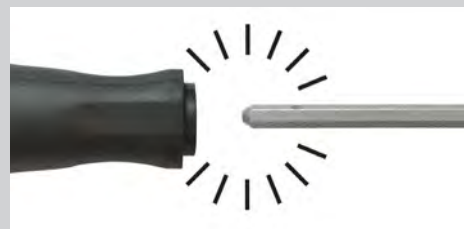

Replaceable blades snap into handle, simplifying blade replacement.



Ergonomically designed handles deliver unrivaled comfort and grip.



Slight texture of handle helps retain grip, even when hands are wet or oily.



The Bondhus ComfortGrip handle features a durable thermoplastic core wrapped in cushioned rubber for increased comfort and torque.

TORX® and TORX PLUS® are trademarks of Acument Intellectual Properties, LLC.

* TEFLON® is a registered trademark of E.I. du Pont de Nemours and Co.

ClickSet™ TLD (Torque Limiting Device)

- TuffKote™ Finish -

- Wide range of factory preset torque limiting handles – no adjustment needed
- When the preset torque level is reached, the mechanism slips and makes an audible “click”
- Protects from overtorquing
- Reduces fastener wear and stripping
- Reduces potential damage to carbide inserts
- +/- 10% repeatability

Impermeable PTFE finish for extra corrosion protection

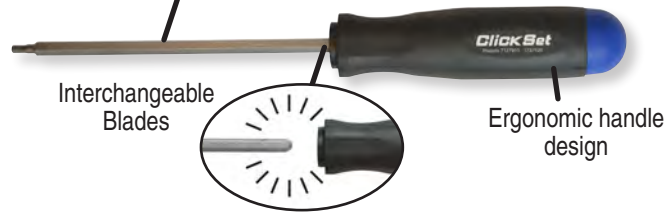

	PART #	TORQUE	QTY	LIST PRICE
Handles Only	50404	4.4 in-lb/0.5 Nm	1	\$26.91
	50405	5.3 in-lb/0.6 Nm	1	\$26.91
	50408	8.0 in-lb/0.9 Nm	1	\$26.91
	50409	9.7 in-lb/1.1 Nm	1	\$26.91
	50410	10.6 in-lb/1.2 Nm	1	\$26.91
	50412	12.4 in-lb/1.4 Nm	1	\$26.91
	50417	17.7 in-lb/2.0 Nm	1	\$26.91
	50422	22.1 in-lb/2.5 Nm	1	\$26.91
	50426	26.6 in-lb/3.0 Nm	1	\$26.91
	50431	31.0 in-lb/3.5 Nm	1	\$26.91

	PART #	TIP	DRIVE	QTY	LIST PRICE
Inch Hex	50102	.050"	5mm	1	\$9.32
	50103	1/16"	5mm	1	\$9.32
	50104	5/64"	5mm	1	\$9.32
	50105	3/32"	5mm	1	\$9.32
	50106	7/64"	5mm	1	\$9.32
	50107	1/8"	5mm	1	\$9.32

Metric Hex	50150	1.5mm	5mm	1	\$9.32
	50152	2.0mm	5mm	1	\$9.32
	50154	2.5mm	5mm	1	\$9.32
	50156	3.0mm	5mm	1	\$9.32

TORX®	50205	T5	5mm	1	\$9.32
	50206	T6	5mm	1	\$9.32
	50207	T7	5mm	1	\$9.32
	50208	T8	5mm	1	\$9.32
	50209	T9	5mm	1	\$9.32
	50210	T10	5mm	1	\$9.32
	50215	T15	5mm	1	\$9.32

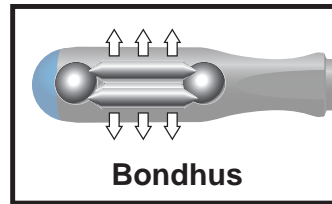

Bondhus ClickSet™ Torque Limiting Screwdrivers distribute the torque load along the handle, redistributing force over a larger surface for greater accuracy and longer tool life.

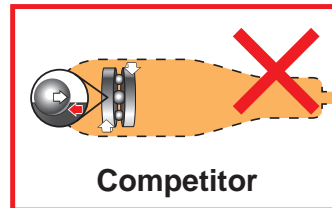

Competitor torque limiting tools use ball bearings or teeth to carry the torque load across the handle, wearing out the mechanism quickly.



	PART #	TIP	DRIVE	QTY	LIST PRICE
TORX PLUS®	50305	5 IP	5mm	1	\$9.32
	50306	6 IP	5mm	1	\$9.32
	50307	7 IP	5mm	1	\$9.32
	50308	8 IP	5mm	1	\$9.32
	50309	9 IP	5mm	1	\$9.32
	50310	10 IP	5mm	1	\$9.32
	50315	15 IP	5mm	1	\$9.32



	PART #	TIP	DRIVE	QTY	LIST PRICE
TORX®	50004	T5	5mm	1	\$36.23
	50005	T6	5mm	1	\$36.23
	50008	T7	5mm	1	\$36.23
	50010	T8	5mm	1	\$36.23
	50012	T9	5mm	1	\$36.23
	50017	T10	5mm	1	\$36.23
	50026	T15	5mm	1	\$36.23

HANDLE TORQUE
4.4 in-lb/0.5 Nm
5.3 in-lb/0.6 Nm
8.0 in-lb/0.9 Nm
10.6 in-lb/1.2 Nm
12.4 in-lb/1.4 Nm
22.1 in-lb/2.5 Nm
31.0 in-lb/3.5 Nm

	PART #	TIP	DRIVE	QTY	LIST PRICE
TORX PLUS®	50054	5 IP	5mm	1	\$36.23
	50055	6 IP	5mm	1	\$36.23
	50058	7 IP	5mm	1	\$36.23
	50060	8 IP	5mm	1	\$36.23
	50062	9 IP	5mm	1	\$36.23
	50067	10 IP	5mm	1	\$36.23
	50076	15 IP	5mm	1	\$36.23

ClickSet™ 1/4" Magnetic Bit Holder

- TuffKote™ Finish -

- Accepts all 1/4" bits



PART #	QTY	LIST PRICE
50125	1	\$15.99

Made in the U.S.A.



All Bondhus® tools are made with Protenium® High Torque Steel.

TORX® and TORX PLUS® are registered trademarks of Acument Intellectual Properties, LLC.

Socket Bits

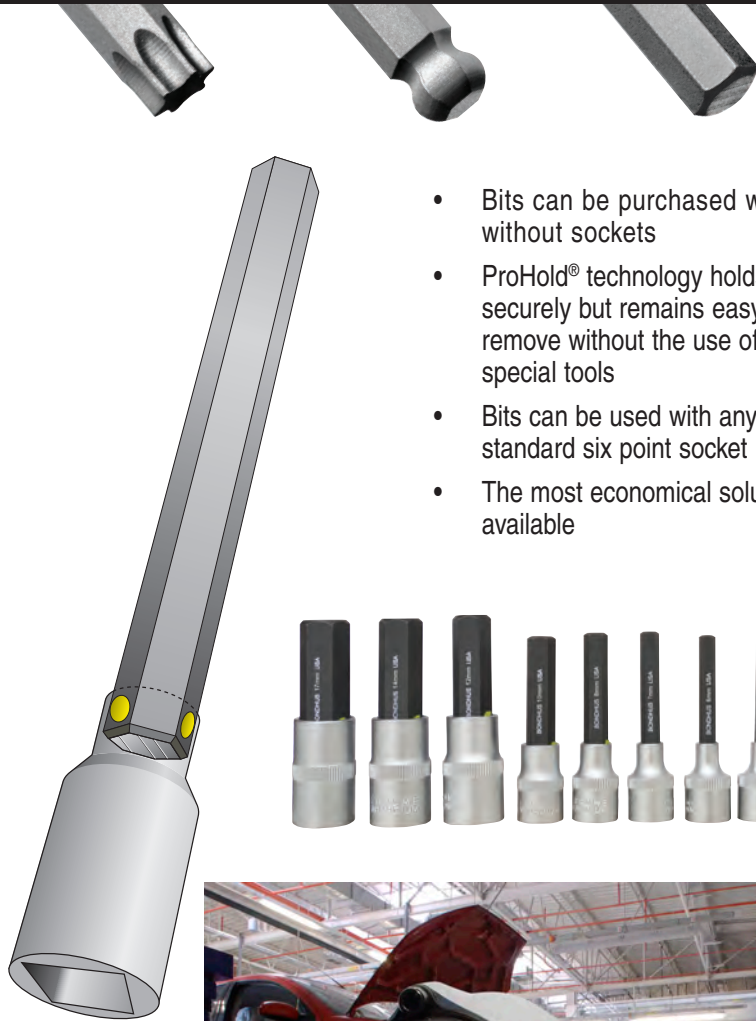

- Bits can be purchased with or without sockets
- ProHold® technology holds bits securely but remains easy to remove without the use of special tools
- Bits can be used with any standard six point socket
- The most economical solution available



High Torque Steel:

Up to 20% stronger, with more torque and twice the wear resistance of standard grades of steel.

FINISH OPTIONS:



Corrosion-resistant finish:

Environmentally safe, provides better tool grip, resists solvents and is 5 times more corrosion resistant than competitor finishes.

ProHold® Socket Bit Technology

Bondhus ProHold® technology is a revolution in holding systems that makes all other holding systems obsolete. Bits seat firmly into socket. No special tools are required to remove bits from sockets.

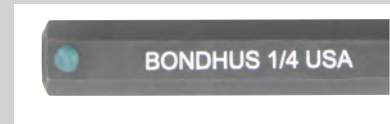

Bit sizes are clearly printed in white ink.



ProHold® buttons hold bit securely while allowing easy removal without the use of set screws or roll pins.



Bits are suitable for use with standard or impact sockets.

Socket Bits

Hex End Socket Bits

- ProGuard™ Finish -

- Bits fit any standard six-point socket
- Bits are suitable for use with impact sockets
- Chamfered tool tips eliminate burrs and help tools seat in screw head
- Sharp corners transfer more torque to the screw and reduce stripping
- Precision machined for ease of use and superior fit

ProGuard™ finish delivers superior corrosion protection

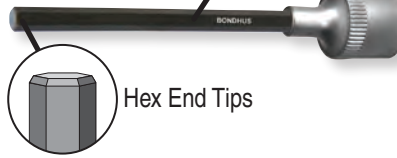

Hex End Tips



Molded Black Case



Clamshell Package

Sets	PART#	MODEL#	PCS	BIT LGTH	DRIVE	DESCRIPTION	PACKED IN	CONTENTS	QTY	LIST	
Inch	43299	PHX9/S-2	9	2"/50mm	3/8" 1/2"	Sockets & Bits	Transparent Clamshell	5/32, 3/16, 7/32, 1/4, 5/16, 3/8, 1/2*, 9/16*, 5/8"	1	\$107.69	
	33299	PHX9-2	9	2"/50mm		Bits Only	Transparent Clamshell	5/32, 3/16, 7/32, 1/4, 5/16, 3/8, 1/2, 9/16, 5/8"	1	\$53.87	
	30299	PHX9/S-2C	9	2"/50mm	3/8" 1/2"	Sockets & Bits	Molded Black Case	5/32, 3/16, 7/32, 1/4, 5/16, 3/8, 1/2*, 9/16*, 5/8"	1	\$123.94	
	23299	PHX9-2C	9	2"/50mm		Bits Only	Molded Black Case	5/32, 3/16, 7/32, 1/4, 5/16, 3/8, 1/2, 9/16, 5/8"	1	\$64.69	
	43645	PHX5/S-6	5	6"/150mm	1/2"	Sockets & Bits	Transparent Clamshell	5/16, 3/8, 1/2, 9/16, 5/8"	1	\$98.27	
	33645	PHX5-6	5	6"/150mm		Bits Only	Transparent Clamshell	5/16, 3/8, 1/2, 9/16, 5/8"	1	\$49.16	
	30645	PHX5/S-6C	5	6"/150mm	1/2"	Sockets & Bits	Molded Black Case	5/16, 3/8, 1/2, 9/16, 5/8"	1	\$114.47	
Metric	43298	PHX9M/S-2	9	2"/50mm	3/8", 1/2"	Sockets & Bits	Transparent Clamshell	4, 5, 6, 7, 8, 10, 12*, 14*, 17mm*	1	\$110.28	
	33298	PHX9M-2	9	2"/50mm		Bits Only	Transparent Clamshell	4, 5, 6, 7, 8, 10, 12, 14, 17mm	1	\$55.17	
	30298	PHX9M/S-2C	9	2"/50mm	3/8", 1/2"	Sockets & Bits	Molded Black Case	4, 5, 6, 7, 8, 10, 12*, 14*, 17mm*	1	\$126.48	
	23246	PHX6M-2C	6	2"/50mm		Bits Only	Molded Black Case	4, 5, 6, 7, 8, 10mm	1	\$45.02	
	23298	PHX9M-2C	9	2"/50mm		Bits Only	Molded Black Case	4, 5, 6, 7, 8, 10, 12, 14, 17mm	1	\$65.93	
	23296	PHX9ML-2C	9	2"/50mm		Bits Only	Molded Black Case	5, 6, 7, 8, 10, 12, 14, 17, 19mm	1	\$74.62	
	43646	PHX6M/S-6	6	6"/150mm	3/8"	Sockets & Bits	Transparent Clamshell	4, 5, 6, 7, 8, 10mm	1	\$80.94	
	33646	PHX6M-6	6	6"/150mm		Bits Only	Transparent Clamshell	4, 5, 6, 7, 8, 10mm	1	\$40.52	
		30646	PHX6M/S-6C	6	6"/150mm	3/8"	Sockets & Bits	Molded Black Case	4, 5, 6, 7, 8, 10mm	1	\$97.19



BIT ONLY



SOCKET AND BIT



BIT ONLY



SOCKET AND BIT

Singles	SIZE	PART#	QTY	LIST EA	PART#	QTY	DRIVE	LIST EA
Inch	2" Long		50mm Long					
	1/8	33207	1	\$6.62	43207	1	3/8"	\$12.16
	5/32	33209	1	\$6.62	43209	1	3/8"	\$12.16
	3/16	33210	1	\$6.78	43210	1	3/8"	\$12.37
	7/32	33211	1	\$6.83	43211	1	3/8"	\$12.42
	1/4	33212	1	\$6.99	43212	1	3/8"	\$12.52
	5/16	33213	1	\$7.30	43213	1	3/8"	\$12.89
	3/8	33214	1	\$7.87	43214	1	3/8"	\$13.40
	7/16	33215	1	\$8.30	-	-	-	-
	1/2	33216	1	\$8.90	43216	1	1/2"	\$15.01
	9/16	33217	1	\$9.30	43217	1	1/2"	\$15.42
	5/8	33218	1	\$10.30	43218	1	1/2"	\$16.40
	3/4	33219	1	\$12.47	43219	1	1/2"	\$21.22
Inch	2.5" Long		65mm Long					
	7/8	33220	1	\$14.75	-	-	-	-
	1	33221	1	\$22.25	-	-	-	-
	1 1/8	33223	1	\$23.81	-	-	-	-
	1 1/4	33225	1	\$28.98	-	-	-	-
	1 1/2	33229	1	\$36.74	-	-	-	-
	1 3/4	33231	1	\$45.54	-	-	-	-
	2	33233	1	\$51.74	-	-	-	-
Inch	6" Long		150mm Long					
	1/8	33607	1	\$6.78	43507	1	3/8"	\$12.52
	5/32	33609	1	\$6.78	43509	1	3/8"	\$12.52
	3/16	33610	1	\$7.04	43510	1	3/8"	\$12.89
	7/32	33611	1	\$7.30	43511	1	3/8"	\$13.20
	1/4	33612	1	\$7.56	43512	1	3/8"	\$13.61
	5/16	33613	1	\$8.69	43513	1	3/8"	\$14.18
	3/8	33614	1	\$10.04	43514	1	3/8"	\$14.80
	5/16	-	-	-	43613	1	1/2"	\$15.53
	3/8	-	-	-	43614	1	1/2"	\$16.87
	7/16	33615	1	\$11.91	-	-	-	-
	1/2	33616	1	\$13.77	43616	1	1/2"	\$20.65
	9/16	33617	1	\$15.58	43617	1	1/2"	\$22.51
5/8	33618	1	\$17.23	43618	1	1/2"	\$24.17	
3/4	33619	1	\$22.72	43619	1	1/2"	\$30.58	

Singles	SIZE	PART#	QTY	LIST EA	PART#	QTY	DRIVE	LIST EA
Metric	2" Long		50mm Long					
	3.0	33256	1	\$6.57	43256	1	3/8"	\$12.11
	4.0	33260	1	\$6.62	43260	1	3/8"	\$12.16
	5.0	33264	1	\$6.78	43264	1	3/8"	\$12.47
	6	33268	1	\$7.04	43268	1	3/8"	\$12.73
	7	33270	1	\$7.19	43270	1	3/8"	\$12.94
	8	33272	1	\$7.30	43272	1	3/8"	\$13.04
	9	33274	1	\$7.92	43274	1	3/8"	\$13.61
	10	33276	1	\$7.92	43276	1	3/8"	\$13.61
	12	33280	1	\$9.26	43280	1	1/2"	\$14.90
	14	33284	1	\$9.63	43284	1	1/2"	\$15.89
	17	33286	1	\$11.80	43286	1	1/2"	\$18.06
	19	33288	1	\$12.94	43288	1	1/2"	\$21.53
Metric	2.5" Long		65mm Long					
	22	33291	1	\$22.25	-	-	-	-
	24	33293	1	\$23.81	-	-	-	-
	27	33295	1	\$28.98	-	-	-	-
	32	33297	1	\$40.37	-	-	-	-
	36	33200	1	\$46.58	-	-	-	-
Metric	6" Long		150mm Long					
	3.0	33656	1	\$6.73	43656	1	3/8"	\$12.16
	4.0	33660	1	\$6.73	43660	1	3/8"	\$12.21
	5.0	33664	1	\$7.09	43664	1	3/8"	\$12.58
	6	33668	1	\$7.61	43668	1	3/8"	\$13.14
	7	33670	1	\$8.59	43670	1	3/8"	\$14.18
	8	33672	1	\$9.26	43672	1	3/8"	\$15.53
	9	33674	1	\$10.30	43674	1	3/8"	\$16.87
	10	33676	1	\$10.30	43676	1	3/8"	\$16.87
	12	33680	1	\$13.09	43680	1	1/2"	\$21.32
	14	33684	1	\$14.13	43684	1	1/2"	\$22.56
	17	33686	1	\$18.68	43686	1	1/2"	\$28.20
	19	33688	1	\$23.18	43688	1	1/2"	\$33.90



Ball End Socket Bits - ProGuard™ Finish -

- Bits fit any standard six-point socket
- Ball End inserts into a screw at a 25° angle
- Ball End saves time by quickly funneling tool into screw
- Superior Ball End strength and working angle

ProGuard™ finish delivers superior corrosion protection



Ball End Tips



Molded Black Case



Clamshell Package

Sets	PART#	MODEL#	PCS	BIT LGTH	DRIVE	DESCRIPTION	PACKED IN	CONTENTS	QTY	LIST
Inch	31445	PHBX7-2	7	2"/50mm		Bits Only	Transparent Clamshell	1/8, 5/32, 3/16, 7/32, 1/4, 5/16, 3/8"	1	\$42.95
	23445	PHBX7-2C	7	2"/50mm		Bits Only	Molded Black Case	1/8, 5/32, 3/16, 7/32, 1/4, 5/16, 3/8"	1	\$53.77
	43445	PHBX7/S-2	7	2"/50mm	3/8"	Sockets & Bits	Transparent Clamshell	1/8, 5/32, 3/16, 7/32, 1/4, 5/16, 3/8"	1	\$86.11
	30445	PHBX7/S-2C	7	2"/50mm	3/8"	Sockets & Bits	Molded Black Case	1/8, 5/32, 3/16, 7/32, 1/4, 5/16, 3/8"	1	\$102.31
	31645	PHBX7-6	7	6"/150mm		Bits Only	Transparent Clamshell	1/8, 5/32, 3/16, 7/32, 1/4, 5/16, 3/8"	1	\$48.39
	43845	PHBX7/S-6	7	6"/150mm	3/8"	Sockets & Bits	Transparent Clamshell	1/8, 5/32, 3/16, 7/32, 1/4, 5/16, 3/8"	1	\$96.82
	30845	PHBX7/S-6C	7	6"/150mm	3/8"	Sockets & Bits	Molded Black Case	1/8, 5/32, 3/16, 7/32, 1/4, 5/16, 3/8"	1	\$113.02
Metric	31487	PHBX8M-2	8	2"/50mm		Bits Only	Transparent Clamshell	3, 4, 5, 6, 7, 8, 9, 10mm	1	\$50.09
	23487	PHBX8M-2C	8	2"/50mm		Bits Only	Molded Black Case	3, 4, 5, 6, 7, 8, 9, 10mm	1	\$60.91
	43487	PHBX8M/S-2	8	2"/50mm	3/8"	Sockets & Bits	Transparent Clamshell	3, 4, 5, 6, 7, 8, 9, 10mm	1	\$99.83
	30487	PHBX8M/S-2C	8	2"/50mm	3/8"	Sockets & Bits	Molded Black Case	3, 4, 5, 6, 7, 8, 9, 10mm	1	\$116.02
	31687	PHBX8M-6	8	6"/150mm		Bits Only	Transparent Clamshell	3, 4, 5, 6, 7, 8, 9, 10mm	1	\$55.32
	43887	PHBX8M/S-6	8	6"/150mm	3/8"	Sockets & Bits	Transparent Clamshell	3, 4, 5, 6, 7, 8, 9, 10mm	1	\$110.64
	30887	PHBX8M/S-6C	8	6"/150mm	3/8"	Sockets & Bits	Molded Black Case	3, 4, 5, 6, 7, 8, 9, 10mm	1	\$126.89



Singles	SIZE	PART#	QTY	LIST EA	PART#	QTY	DRIVE	LIST EA
Inch	2" Long		50mm Long					
	1/8	31407	1	\$7.25	43407	1	3/8"	\$12.99
	5/32	31409	1	\$7.30	43409	1	3/8"	\$13.20
	3/16	31410	1	\$7.45	43410	1	3/8"	\$13.40
	7/32	31411	1	\$7.50	43411	1	3/8"	\$13.51
	1/4	31412	1	\$7.66	43412	1	3/8"	\$13.66
	5/16	31413	1	\$8.02	43413	1	3/8"	\$14.18
	3/8	31414	1	\$8.44	43414	1	3/8"	\$14.70
	5/16	-	-	-	43913	1	1/2"	\$14.70
	3/8	-	-	-	43914	1	1/2"	\$15.27
	1/2	31416	1	\$9.83	43916	1	1/2"	\$17.13
	9/16	31417	1	\$10.30	43917	1	1/2"	\$17.75
	5/8	31418	1	\$11.13	43918	1	1/2"	\$18.89
	3/4	31419	1	\$13.51	43919	1	1/2"	\$23.75
	Inch	6" Long		150mm Long				
1/8		31607	1	\$7.25	43807	1	3/8"	\$13.40
5/32		31609	1	\$7.45	43809	1	3/8"	\$13.87
3/16		31610	1	\$7.87	43810	1	3/8"	\$14.23
7/32		31611	1	\$8.12	43811	1	3/8"	\$14.59
1/4		31612	1	\$9.26	43812	1	3/8"	\$15.06
5/16		31613	1	\$9.47	43813	1	3/8"	\$16.77
3/8		31614	1	\$10.92	43814	1	3/8"	\$18.22
1/2		31616	1	\$14.85	43716	1	1/2"	\$22.51
9/16		31617	1	\$17.03	43717	1	1/2"	\$24.53
5/8		31618	1	\$18.68	43718	1	1/2"	\$29.76
3/4		31619	1	\$24.79	43719	1	1/2"	\$36.69

Singles	SIZE	PART#	QTY	LIST EA	PART#	QTY	DRIVE	LIST EA
Metric	2" Long		50mm Long					
	3.0	31456	1	\$7.25	43456	1	3/8"	\$13.14
	4.0	31460	1	\$7.25	43460	1	3/8"	\$13.14
	5.0	31464	1	\$7.45	43464	1	3/8"	\$13.40
	6	31468	1	\$7.66	43468	1	3/8"	\$13.71
	7	31470	1	\$7.87	43470	1	3/8"	\$13.71
	8	31472	1	\$8.07	43472	1	3/8"	\$14.23
	9	31474	1	\$8.28	43474	1	3/8"	\$14.54
	10	31476	1	\$8.69	43476	1	3/8"	\$15.06
	12	31480	1	\$9.94	43480	1	3/8"	\$16.55
	12	-	-	-	43980	1	1/2"	\$17.13
	14	31484	1	\$10.35	43984	1	1/2"	\$17.75
Metric	6" Long		150mm Long					
	3.0	31656	1	\$7.25	43856	1	3/8"	\$13.40
	4.0	31660	1	\$7.45	43860	1	3/8"	\$13.87
	5.0	31664	1	\$7.87	43864	1	3/8"	\$14.23
	6	31668	1	\$8.44	43868	1	3/8"	\$15.06
	7	31670	1	\$9.47	43870	1	3/8"	\$15.58
	8	31672	1	\$10.25	43872	1	3/8"	\$16.09
	9	31674	1	\$10.30	43874	1	3/8"	\$16.35
	10	31676	1	\$11.23	43876	1	3/8"	\$17.49
	12	31680	1	\$14.18	43780	1	1/2"	\$22.82
	14	31684	1	\$15.32	43784	1	1/2"	\$24.27
	17	31686	1	\$20.08	43786	1	1/2"	\$29.76
19	31688	1	\$24.74	43788	1	1/2"	\$36.69	

TORX® Socket Bits

- ProGuard™ Finish -

- Fits all TORX® and Star screws
- Bits fit any standard six point socket
- Bits are suitable for use with impact sockets
- Burr free tool tips help tools seat fully in screw head
- Precision machined tips transfer more torque to the screw and reduces stripping

ProGuard™ finish delivers superior corrosion protection



Molded Black Case



Clamshell Package

TORX® & Metric Hex

PART#	MODEL#	PCS	BIT LENGTH	DESCRIPTION	PACKED IN	CONTENTS	QTY	LIST
23290	PHTXH7-2C	7	2"/50mm	Bits Only	Molded Black Case	T45, T50, T55 & 12, 14, 17, 19mm	1	\$71.36

Sets	PART#	MODEL#	PCS	BIT LGTH	DRIVE	DESCRIPTION	PACKED IN	CONTENTS	QTY	LIST
TORX®	32038	PHTX10-2	10	2"/50mm		Bits Only	Transparent Clamshell	T10, T15, T20, T25, T27, T30, T40, T45, T50, T55	1	\$52.99
	32037	PHTX13-2	13	2"/50mm		Bits Only	Transparent Clamshell	T8, T10, T15, T20, T25, T27, T30, T40, T45, T47, T50, T55, T60	1	\$72.97
	22491	PHTX9-2C	9	2"/50mm		Bits Only	Molded Black Case	T8, T9, T10, T15, T20, T25, T27, T30, T40	1	\$58.84
	22489	PHTX9L-2C	9	2"/50mm		Bits Only	Molded Black Case	T15, T20, T25, T30, T40, T45, T50, T55, T60	1	\$74.62
	22437	PHTX13-2C	13	2"/50mm		Bits Only	Molded Black Case	T8, T10, T15, T20, T25, T27, T30, T40, T45, T47, T50, T55, T60	1	\$83.78
	44038	PHTX10/S-2	10	2"/50mm	1/4"	Sockets & Bits	Transparent Clamshell	T10, T15, T20, T25, T27, T30, T40*, T45*, T50*, T55*	1	\$102.21
	44037	PHTX13/S-2	13	2"/50mm	1/4", 3/8"	Sockets & Bits	Transparent Clamshell	T8, T10, T15, T20, T25, T27, T30, T40*, T45*, T47*, T50*, T55*, T60**	1	\$135.64
	31038	PHTX10/S-2C	10	2"/50mm	1/4", 3/8"	Sockets & Bits	Molded Black Case	T10, T15, T20, T25, T27, T30, T40*, T45*, T50*, T55*	1	\$118.46
	31037	PHTX13/S-2C	13	2"/50mm	1/4"	Sockets & Bits	Molded Black Case	T8, T10, T15, T20, T25, T27, T30, T40*, T45*, T47*, T50*, T55*, T60**	1	\$151.83
	34032	PHTX8-6	8	6"/150mm		Bits Only	Transparent Clamshell	T8, T10, T15, T20, T25, T27, T30, T40	1	\$44.56
	34099	PHTX9-6	9	6"/150mm		Bits Only	Transparent Clamshell	T8, T9, T10, T15, T20, T25, T27, T30, T40	1	\$50.30
	44632	PHTX8/S-6	8	6"/150mm		Sockets & Bits	Transparent Clamshell	T8, T10, T15, T20, T25, T27, T30, T40	1	\$82.18
	44699	PHTX9/S-6	9	6"/150mm	1/4", 3/8"	Sockets & Bits	Transparent Clamshell	T8, T9, T10, T15, T20, T25, T27, T30, T40*	1	\$91.96
	30799	PHTX9/S-6C	9	6"/150mm	1/4", 3/8"	Sockets & Bits	Molded Black Case	T8, T9, T10, T15, T20, T25, T27, T30, T40*	1	\$108.16

Singles	SIZE	BIT STOCK	BIT ONLY				SOCKET AND BIT											
			PART#	QTY	LIST	EA	PART#	QTY	DRIVE	LIST	EA							
TORX®	2" Long		50mm Long															
	T7	3mm	32007	1	\$10.34	44007	1	1/4"	\$17.13	-	-	-	-					
	T8	3mm	32008	1	\$10.34	44008	1	1/4"	\$17.13	T8	3mm	34008	1	\$10.45	44608	1	1/4"	\$17.28
	T9	3mm	32009	1	\$10.34	44009	1	1/4"	\$17.13	T9	3mm	34009	1	\$10.45	44609	1	1/4"	\$17.28
	T10	3mm	32010	1	\$10.34	44010	1	1/4"	\$17.13	T10	3mm	34010	1	\$10.45	44610	1	1/4"	\$17.28
	T15	3mm	32015	1	\$9.26	44015	1	1/4"	\$15.16	T15	3mm	34015	1	\$9.47	44615	1	1/4"	\$15.47
	T20	4mm	32020	1	\$9.16	44020	1	1/4"	\$14.85	T20	4mm	34020	1	\$9.47	44620	1	1/4"	\$15.47
	T25	4mm	32025	1	\$9.16	44025	1	1/4"	\$14.85	T25	4mm	34025	1	\$9.52	44625	1	1/4"	\$15.58
	T27	5mm	32027	1	\$9.26	44027	1	1/4"	\$15.16	T27	5mm	34027	1	\$9.57	44627	1	1/4"	\$15.68
	T30	5mm	32030	1	\$9.26	44030	1	1/4"	\$15.16	T30	5mm	34030	1	\$9.94	44630	1	1/4"	\$16.04
	T40	6mm	32040	1	\$10.30	44240	1	3/8"	\$17.03	T40	6mm	34040	1	\$10.97	44640	1	3/8"	\$18.27
	T45	7mm	32045	1	\$10.35	44245	1	3/8"	\$17.23	-	-	-	-	-	-	-	-	
	T47	8mm	32047	1	\$10.51	44247	1	3/8"	\$17.49	-	-	-	-	-	-	-	-	
	T50	9mm	32050	1	\$10.66	44250	1	3/8"	\$17.75	-	-	-	-	-	-	-	-	
T55	10mm	32055	1	\$11.13	44255	1	3/8"	\$18.68	-	-	-	-	-	-	-	-		
T60	12mm	32060	1	\$12.21	44260	1	1/2"	\$20.69	-	-	-	-	-	-	-	-		
T70	17mm	32070	1	\$20.70	-	-	-	-	-	-	-	-	-	-	-	-		
T80	19mm	32080	1	\$21.22	-	-	-	-	-	-	-	-	-	-	-	-		
T90*	22mm	32090*	1	\$31.05	-	-	-	-	-	-	-	-	-	-	-	-		
T100*	22mm	32000*	1	\$36.23	-	-	-	-	-	-	-	-	-	-	-	-		

*32090 (T90) & 32000 (T100) are 2.5" long.



All Bondhus® tools are made with Protenium® High Torque Steel.

TORX® and TORX PLUS® are registered trademarks of Acument Intellectual Properties, LLC.

Made in the U.S.A.

HandyHex™ Adjustable Handle

Hollow Hex handle allows adjustment of the distance a hex blade extends from the handle



	PART #	SIZE	QTY	LIST PRICE
Handles Only	86900	.028-5/64" + 1.27-2.0mm	1	\$15.00
	86901	3/32-7/64" + 2.5mm	1	\$15.00
	86902	1/8-9/64" + 3.0-3.5mm	1	\$15.00

	PART #	SIZE	QTY	LIST PRICE
Inch	87900	.028	1	\$16.99
	87901	.035	1	\$16.99
	87902	.050	1	\$16.99
	87903	1/16	1	\$16.99
	87904	5/64	1	\$16.99
	87905	3/32	1	\$16.99
	87906	7/64	1	\$16.99
	87907	1/8	1	\$16.99
	87908	9/64	1	\$16.99



A thumb screw located conveniently at the front of the handle can be tightened to hold the blade or hex wrench solidly in position

The handle allows the user to infinitely adjust the distance the blade extends from the handle because the hole in the handle extends all the way through the handle



The handle will also accept the long or short arms of a hex wrench and act as a handle for the hex wrench



Singles	SIZE	INCH	MM	PART#	QTY	LIST EA
Hex Blades						
Inch	.028	2.6	66	0200	1	\$0.29
	.035	2.6	66	0201	1	\$0.29
	.050	2.6	66	0202	1	\$0.29
	1/16	2.8	71	0203	1	\$0.29
	5/64	3.0	76	0204	1	\$0.29
	3/32	4.0	103	0205	1	\$0.29
	7/64	4.3	109	0206	1	\$0.43
	1/8	4.5	115	0207	1	\$0.47
	9/64	4.8	122	0208	1	\$0.55
	5/64	5.9	150	1104	1	\$0.70
	3/32	5.9	150	1105	1	\$0.70
	7/64	5.9	150	1106	1	\$0.88
	1/8	5.9	150	1107	1	\$0.89
	9/64	5.9	150	1108	1	\$1.09
	5/64	8.9	226	1204	1	\$1.64
	3/32	8.9	226	1205	1	\$1.64
	7/64	8.9	226	1206	1	\$1.87
	1/8	8.9	226	1207	1	\$1.94
	9/64	8.9	226	1208	1	\$2.17



Singles	SIZE	INCH	MM	PART#	QTY	LIST EA
Hex Blades						
Metric	1.5	2.8	70	0250	1	\$0.26
	2.0	3.8	98	0252	1	\$0.26
	2.5	4.2	107	0254	1	\$0.30
	3.0	4.6	118	0256	1	\$0.47
	2.0	5.9	150	1152	1	\$0.62
	2.5	5.9	150	1154	1	\$0.68
	3.0	5.9	150	1156	1	\$0.87
	2.0	8.9	226	1252	1	\$1.57
	2.5	8.9	226	1254	1	\$1.64
	3.0	8.9	226	1256	1	\$1.89

Ball End blades that fit the HandyHex™ Handle can be found on page 57. L-wrenches can be found throughout the catalog.

Ball End Blades

- ProGuard™ Finish -

- Ball End inserts into a screw at a 25° angle
- Ball End saves time by quickly funneling tool into screw
- Superior Ball End strength and working angle
- Works in hard to reach places
- Ideal for use in socket wrenches, power tools or with a Hextender for added reach
- Available in Extra Long lengths

ProGuard™ finish delivers superior corrosion protection

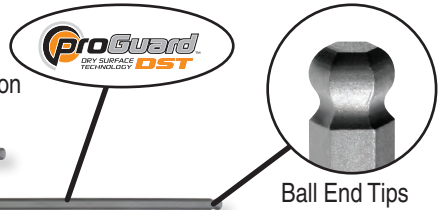

Singles	SIZE	INCH	MM	PART#	QTY	LIST EA
Standard Length						
Inch	.050	3.4	86	0102	1	\$1.02
	1/16	3.5	89	0103	1	\$1.02
	5/64	3.6	93	0104	1	\$1.02
	3/32	3.8	96	0105	1	\$1.06
	7/64	4.3	109	0106	1	\$1.20
	1/8	4.5	115	0107	1	\$1.23
	9/64	4.8	121	0108	1	\$1.23
	5/32	5.1	129	0109	1	\$1.29
	3/16	5.5	139	0110	1	\$1.50
	7/32	5.9	151	0111	1	\$1.81
	1/4	6.7	170	0112	1	\$2.07
	5/16	7.3	186	0113	1	\$3.28
	3/8	8.2	208	0114	1	\$4.62
	7/16	9.1	232	0115	1	\$9.56
	1/2	10.1	255	0116	1	\$12.23
	9/16	10.9	277	0117	1	\$14.96
	5/8	11.8	299	0118	1	\$16.73
	3/4	13.5	344	0119	1	\$27.67



Singles	SIZE	INCH	MM	PART#	QTY	LIST EA
Standard Length						
Metric	1.5	3.6	91	0150	1	\$1.02
	2.0	3.8	98	0152	1	\$1.02
	2.5	4.2	107	0154	1	\$1.09
	3.0	4.6	118	0156	1	\$1.21
	3.5	4.8	123	0158	1	\$1.26
	4.0	5.2	133	0160	1	\$1.29
	4.5	5.5	140	0162	1	\$1.49
	5.0	5.8	148	0164	1	\$1.65
	5.5	6.1	155	0166	1	\$1.91
	6	6.7	170	0168	1	\$2.20
	7	7.3	184	0170	1	\$2.97
	8	7.8	199	0172	1	\$3.51
	9	8.4	214	0174	1	\$4.22
	10	9.0	229	0176	1	\$5.13
	11	9.6	245	0178	1	\$9.46
	12	10.5	267	0180	1	\$11.34
	14	12.5	318	0184	1	\$14.18
	17	13.6	346	0186	1	\$22.51
	19	14.5	368	0188	1	\$26.69



Singles	SIZE	INCH	MM	PART#	QTY	LIST EA	
Long							
Inch	-	-	-	-	-	-	
	5/64	5.3	135	0404	1	\$1.79	
	3/32	5.8	148	0405	1	\$1.79	
	7/64	7.3	186	0406	1	\$1.79	
	1/8	7.8	199	0407	1	\$2.10	
	9/64	8.4	214	0408	1	\$2.10	
	5/32	8.9	227	0409	1	\$3.05	
	3/16	9.7	246	0410	1	\$3.13	
	7/32	10.2	259	0411	1	\$3.64	
	1/4	10.7	270	0412	1	\$4.50	
	5/16	11.3	286	0413	1	\$6.58	
	3/8	11.7	297	0414	1	\$7.34	
	-	-	-	-	-	-	-
	-	-	-	-	-	-	-
Long							
Metric	-	-	-	-	-	-	
	2.0	5.0	128	0452	1	\$1.79	
	2.5	5.8	148	0454	1	\$1.79	
	3.0	7.6	193	0456	1	\$2.10	
	4.0	8.5	217	0460	1	\$2.40	
	5.0	9.6	243	0464	1	\$3.22	
	6	10.4	263	0468	1	\$4.13	
	8	11.1	281	0472	1	\$5.53	
	10	11.9	303	0476	1	\$8.39	



Singles	SIZE	INCH	MM	PART#	QTY	LIST EA
Extra Long						
Inch	.050	12.0	305	3602	1	\$6.93
	1/16	12.0	305	3603	1	\$6.93
	5/64	12.0	305	3604	1	\$6.93
	3/32	12.0	305	3605	1	\$6.99
	7/64	12.0	305	3606	1	\$7.05
	1/8	12.0	305	3607	1	\$7.11
	9/64	12.0	305	3608	1	\$7.23
	5/32	12.0	305	3609	1	\$7.47
	3/16	12.0	305	3610	1	\$7.85
	7/32	12.0	305	3611	1	\$7.85
	1/4	12.0	305	3612	1	\$7.85
	5/16	12.0	305	3613	1	\$8.92
	3/8	12.0	305	3614	1	\$10.66
	7/16	12.0	305	3615	1	\$12.58
	1/2	12.0	305	3616	1	\$14.40
	Extra Long					
Metric	1.5	12.0	305	3650	1	\$6.93
	2.0	12.0	305	3652	1	\$6.93
	2.5	12.0	305	3654	1	\$6.99
	3.0	12.0	305	3656	1	\$7.11
	4.0	12.0	305	3660	1	\$7.47
	5.0	12.0	305	3664	1	\$7.85
	6	12.0	305	3668	1	\$7.85
	8	12.0	305	3672	1	\$8.91
	10	12.0	305	3676	1	\$10.80

Ball End Power Bits

- ProGuard™ Finish -

- Fits all 1/4" drive bit holders
- Ball End inserts into a screw at a 25° angle
- Ball End saves time by quickly funneling tool into screw
- Superior Ball End strength and working angle
- Works in hard to reach places

ProGuard™ finish delivers superior corrosion protection

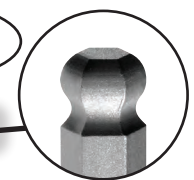

Ball End Tips

Sets	PART#	MODEL#	LENGTH	PCS	CONTENTS	QTY	LIST
Inch	10836	BHX12	3"	12	5/64, 3/32, 7/64, 1/8, 9/64, 5/32, 3/16, 7/32, 1/4, 5/16, 3/8, 1/2"	1	\$37.98
Metric	10899	BHX9M	3"	9	2, 2.5, 3, 4, 5, 6, 8, 10, 12mm	1	\$32.65

SINGLE PACKAGING



Singles	SIZE	INCH	MM	PART#	QTY	LIST EA
Inch	5/64	3.0	76	10804	10	\$2.13
	3/32	3.0	76	10805	10	\$2.13
	7/64	3.0	76	10806	10	\$2.13
	1/8	3.0	76	10807	10	\$2.13
	9/64	3.0	76	10808	10	\$2.13
	5/32	3.0	76	10809	10	\$2.13
	3/16	3.0	76	10810	10	\$2.13
	7/32	3.0	76	10811	10	\$2.13
	1/4	3.0	76	10812	10	\$2.13
	5/16	3.0	76	10813	1	\$5.96
Metric	3/8	3.0	76	10814	1	\$6.39
	1/2	3.0	76	10816	1	\$7.51
	2.0	3.0	76	10852	10	\$2.13
	2.5	3.0	76	10854	10	\$2.13
	3.0	3.0	76	10856	10	\$2.13
	4.0	3.0	76	10860	10	\$2.13
	5.0	3.0	76	10864	10	\$2.13
	6	3.0	76	10868	10	\$2.13
8	3.0	76	10872	1	\$5.96	
10	3.0	76	10876	1	\$6.52	
12	3.0	76	10880	1	\$7.30	

NEW

ProHold® Hex End Power Bits

- Holds screw tight on the tool EVERY TIME
- Button is non-magnetic
- Super smooth rotational action, with no interference from the ProHold® button
- Tool strength is not compromised by the ProHold® button



SINGLE PACKAGING



Singles	SIZE	INCH	MM	PART#	QTY	LIST EA
Inch	7/64	3.0	76	71306	1	\$6.54
	1/8	3.0	76	71307	1	\$6.54
	9/64	3.0	76	71308	1	\$6.54
	5/32	3.0	76	71309	1	\$6.54
	3/16	3.0	76	71310	1	\$6.54
	7/32	3.0	76	71311	1	\$6.54
	1/4	3.0	76	71312	1	\$6.54
	5/16	3.0	76	71313	1	\$8.06
	3/8	3.0	76	71314	1	\$10.16
	Metric	2.5	3.0	76	71354	1
3.0		3.0	76	71356	1	\$6.54
4.0		3.0	76	71360	1	\$6.54
5.0		3.0	76	71364	1	\$6.54
6		3.0	76	71368	1	\$6.54
8		3.0	76	71372	1	\$8.06
10	3.0	76	71376	1	\$10.29	

NEW

ProHold® TORX® Power Bits

- Fits all TORX® and Star screws
- Holds screw tight on the tool EVERY TIME
- Button is non-magnetic
- Super smooth rotational action, with no interference from the ProHold® button
- Tool strength is not compromised by the ProHold® button
- Broad contact surface provides deep lobe engagement



SINGLE PACKAGING



Singles	SIZE	INCH	MM	PART#	QTY	LIST EA
TORX®	T15	6.0	152	71615	1	\$8.07
	T20	6.0	152	71620	1	\$8.07
	T25	6.0	152	71625	1	\$8.07
	T27	6.0	152	71627	1	\$8.07
	T30	6.0	152	71630	1	\$8.07
	T40	6.0	152	71640	1	\$8.07

Hex End Power Bits

- Chamfered tool tips eliminate burrs and help tools seat in screw head
- Sharp corners transfer more torque to the screw and reduce stripping
- Precision machined for ease of use and superior fit



SINGLE PACKAGING



Singles	SIZE	INCH	MM	PART#	QTY	LIST EA
Inch	7/64	3.0	76	10306	10	\$2.13
	1/8	3.0	76	10307	10	\$2.13
	9/64	3.0	76	10308	10	\$2.13
	5/32	3.0	76	10309	10	\$2.13
	3/16	3.0	76	10310	10	\$2.13
	7/32	3.0	76	10311	10	\$2.13
	1/4	3.0	76	10312	10	\$2.13
	5/16	3.0	76	10313	1	\$5.96
	3/8	3.0	76	10314	1	\$6.39
	Metric	2.5	3.0	76	10354	10
3.0		3.0	76	10356	10	\$2.13
4.0		3.0	76	10360	10	\$2.13
5.0		3.0	76	10364	10	\$2.13
6		3.0	76	10368	10	\$2.13
8		3.0	76	10372	1	\$5.96
10	3.0	76	10376	1	\$6.52	



All Bondhus® tools are made with Protanium® High Torque Steel.

TORX® and TORX PLUS® are registered trademarks of Acument Intellectual Properties, LLC.

Ball End Insert Bits

- ProGuard™ Finish -

- Ball End inserts into a screw at a 25° angle
- Ball End saves time by quickly funneling tool into screw
- Superior Ball End strength and working angle
- Works in hard to reach places

ProGuard™ finish delivers superior corrosion protection

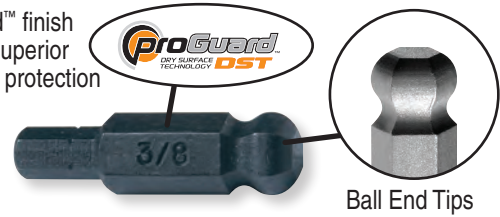

Ball End Tips

Sets	PART#	MODEL#	LENGTH	PCS	CONTENTS	QTY	LIST
Inch	11036	BIX12	1" (5-64-1/4"), 1.5" (5/16-1/2")	12	5/64, 3/32, 7/64, 1/8, 9/64, 5/32, 3/16, 7/32, 1/4, 5/16, 3/8, 1/2"	1	\$31.88
Metric	11099	BIX9M	1" (2.0-6mm), 1.5" (8-10mm)	9	2, 2.5, 3, 4, 5, 6, 8, 10, 12mm	1	\$28.05

SINGLE PACKAGING

Singles	SIZE	INCH	MM	PART#	QTY	LIST EA
Inch	5/64	1.0	25	11004	10	\$1.50
	3/32	1.0	25	11005	10	\$1.50
	7/64	1.0	25	11006	10	\$1.50
	1/8	1.0	25	11007	10	\$1.50
	9/64	1.0	25	11008	10	\$1.50
	5/32	1.0	25	11009	10	\$1.50
	3/16	1.0	25	11010	10	\$1.50
	7/32	1.0	25	11011	10	\$1.50
	1/4	1.0	25	11012	10	\$1.50
	5/16	1.5	38	11013	1	\$5.61
	3/8	1.5	38	11014	1	\$5.85
	1/2	1.5	38	11016	1	\$6.62

SINGLE PACKAGING

Singles	SIZE	INCH	MM	PART#	QTY	LIST EA
Metric	2.0	1.0	25	11052	10	\$1.50
	2.5	1.0	25	11054	10	\$1.50
	3.0	1.0	25	11056	10	\$1.50
	4.0	1.0	25	11060	10	\$1.50
	5.0	1.0	25	11064	10	\$1.50
	6	1.0	25	11068	10	\$1.50
	8	1.5	38	11072	1	\$5.61
	10	1.5	38	11076	1	\$6.08
	12	1.5	38	11080	1	\$6.52

Hextenders

- Extend tool reach
- Allows blades to be coupled with Hex or TORX® tools
- Extra length can be achieved using multiple Hextender/Blade combinations
- ProGuard™ finish delivers superior corrosion protection

SINGLE PACKAGING

Singles	SIZE	INCH	MM	DIA	PART#	QTY	LIST EA
Inch	.050	0.50	13	0.25	22302	1	\$14.43
	1/16	0.50	13	0.25	22303	1	\$14.43
	5/64	0.50	13	0.25	22304	1	\$14.43
	3/32	0.50	13	0.25	22305	1	\$14.43
	7/64	0.50	13	0.25	22306	1	\$14.43
	1/8	0.50	13	0.31	22307	1	\$14.43
	9/64	0.50	13	0.31	22308	1	\$14.43
	5/32	0.75	19	0.37	22309	1	\$14.43
	3/16	0.75	19	0.37	22310	1	\$14.43
	7/32	0.75	19	0.50	22311	1	\$14.43
	1/4	0.75	19	0.50	22312	1	\$14.43
	5/16	1.0	25	0.75	22313	1	\$14.43
	3/8	1.0	25	0.75	22314	1	\$14.43
	Metric	1.5	0.50	13	0.25	22350	1
2.0		0.50	13	0.25	22352	1	\$14.43
2.5		0.50	13	0.25	22354	1	\$14.43
3.0		0.50	13	0.31	22356	1	\$14.43
4.0		0.75	19	0.37	22360	1	\$14.43
5.0		0.75	19	0.37	22364	1	\$14.43
6		0.75	19	0.50	22368	1	\$14.43
8	1.0	25	0.75	22372	1	\$14.43	
10	1.0	25	0.75	22376	1	\$14.43	



Hextender attaches blades to tools

Screw Grab™ Friction Drops



SCREW GRAB

Helps remove
or tighten
stripped screws



- Increase torque by up to 800%
- Tools “Grab” to remove deformed screw heads or rounded hex’s & sockets
- Works instantly
- Easy to use, wipes clean
- Satisfaction guaranteed



- Rounded or deformed heads
- Seized, rusted or hard-to-reach spots
- Sloppy or mis-matched sockets
- Stops bit from turning in a chuck
- Prevent tool wear

APPROVED for use on Boeing Airline Jets, Military Fighter Jets & the RAF. Resulting in SIGNIFICANT LABOR COST REDUCTION in time & efficiency for service departments.

WON THE AWARD OF DISTINCTION FOR INNOVATIVE NEW PRODUCTS from “Retailers Choice Awards”, selected by the National Hardware Show and the Retailers Choice Committee.



PART #	QTY	LIST PRICE
94205	1	\$8.57

The Problem



The SOLUTION

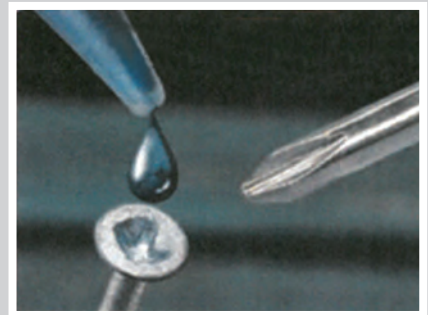

A single dab of **SCREW GRAB** creates a positive grip between metal surfaces (tests have shown as high as 800%) that virtually eliminates tool wear or rounding and deforming of fasteners.

Helps remove all styles
of stripped fasteners

