

# BESSEY Training



**BESSEY Tools North America**  
**Auto Adjust Toggle Clamps: STC**



# BESSEY Auto-Adjust Toggle Clamps



**1** Constant clamping force over range of clamping height

**2** Range of clamping force which is adjustable

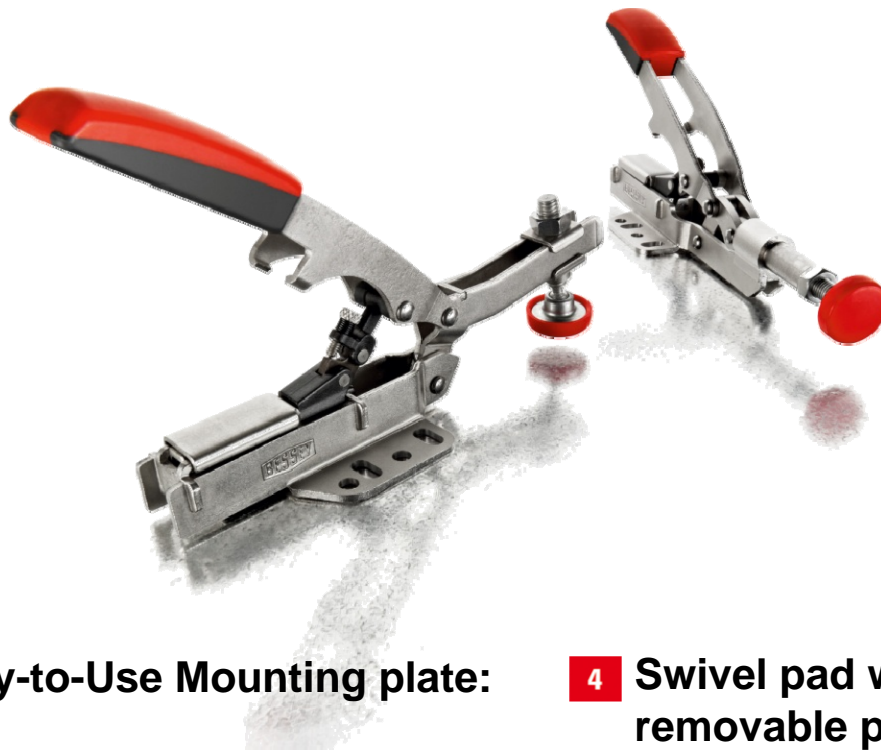

**3** Easy-to-Use Mounting plate:

**4** Swivel pad with removable plastic cap:



# BESSEY Auto-Adjust Toggle Clamps

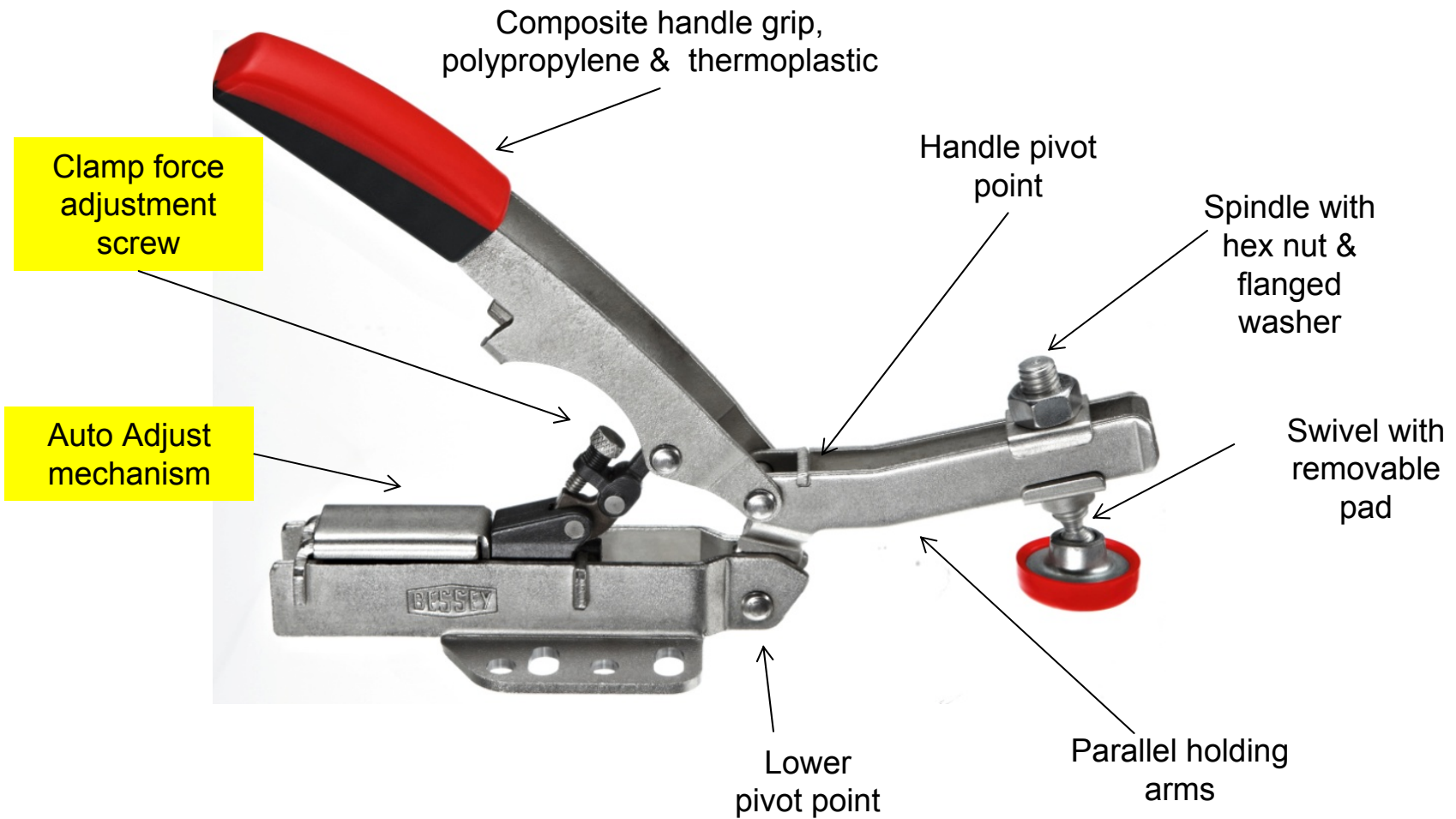

# BESSEY Auto-Adjust Toggle Clamps

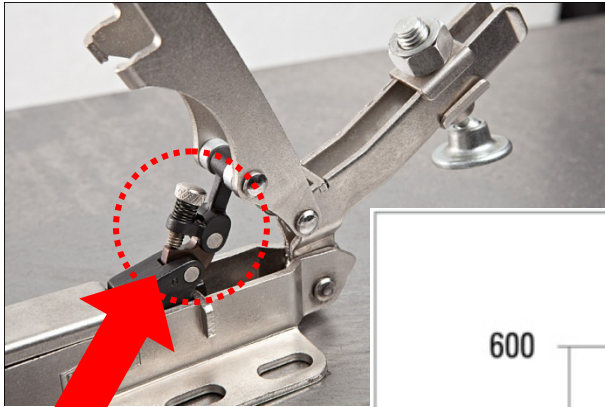

Spannkraft  
Clamping pressure  
Puissance  
Fuerza de sujeción

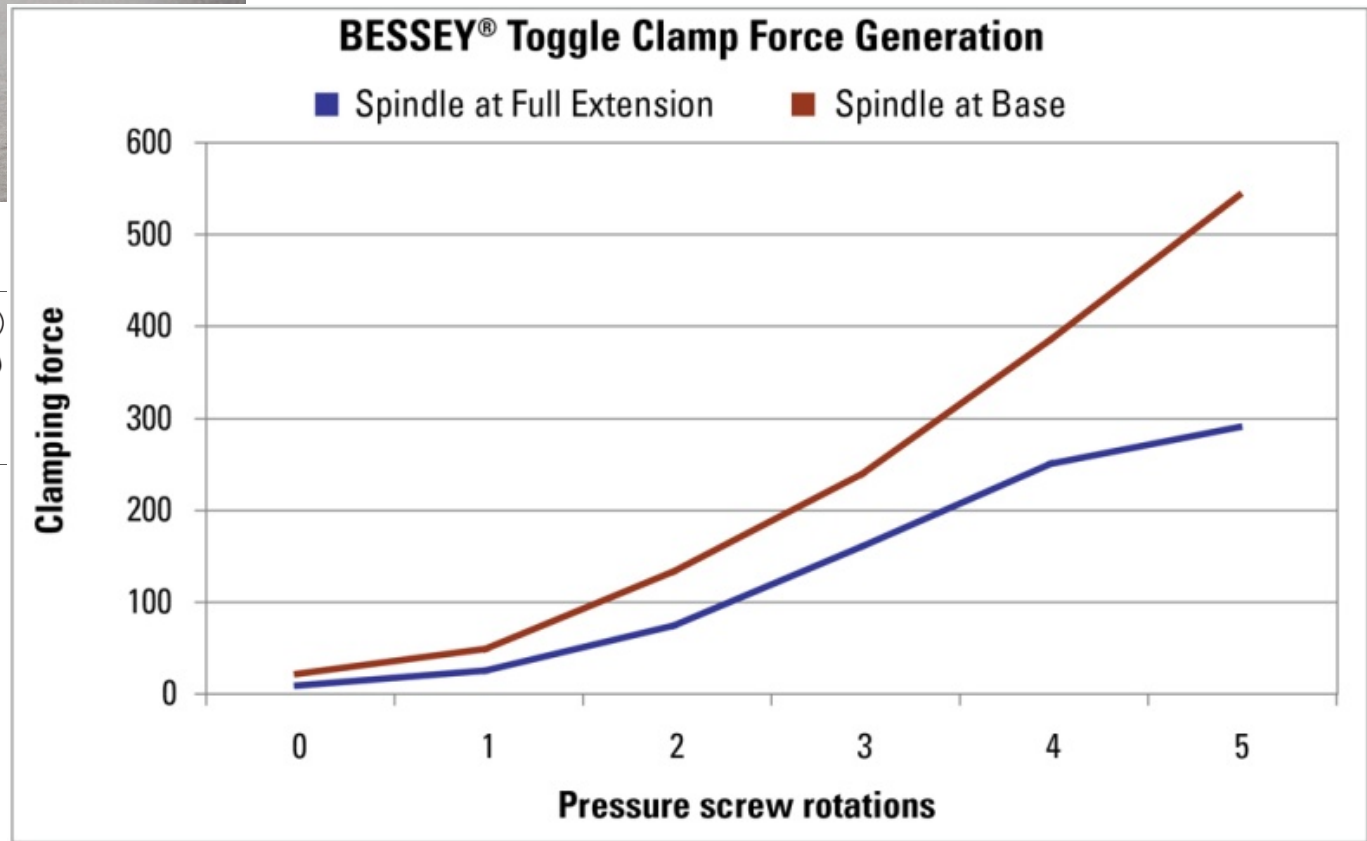

# BESSEY Auto-Adjust Toggle Clamps

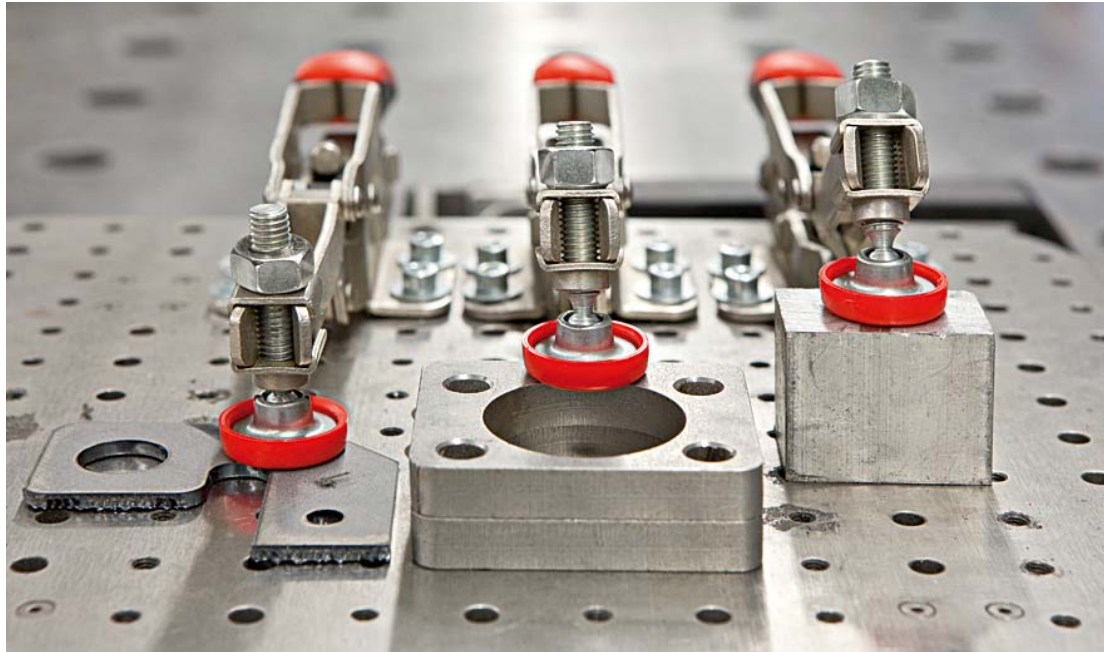

Same clamp model, same settings, Auto-Adjusts to different heights and maintains the same clamping force !!

# BESSEY Auto-Adjust Toggle Clamps



## ❑ Three models, to start

- ▶ Horizontal, low profile, STC-HH50



- ▶ Horizontal, high profile, STC-HH70

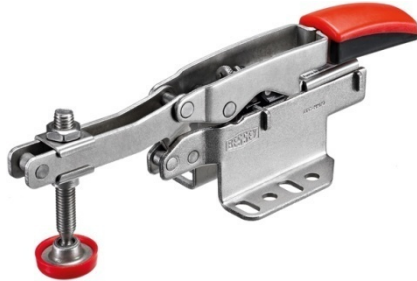

- ▶ InLine, low profile, STC-IHH25

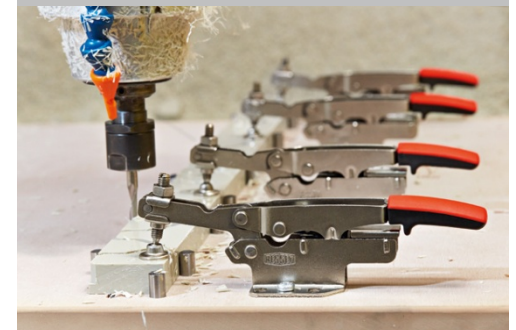
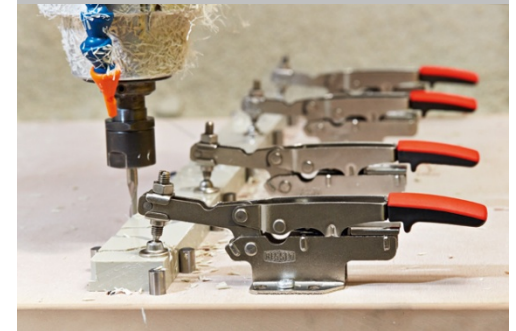
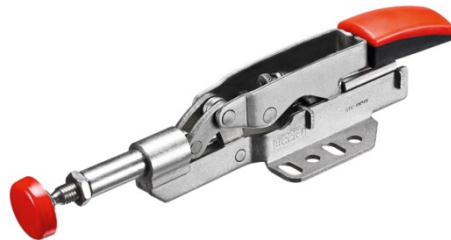

# BESSEY Auto-Adjust Toggle Clamps



## ❑ Five models added in 2013

- ❑ Physically smaller versions (about 2 IN shorter)
- ❑ Maximum clamping capacity of 450 lbs
- ❑ Range of clamping force 25 – 250 lbs
- ❑ Choice of base styles

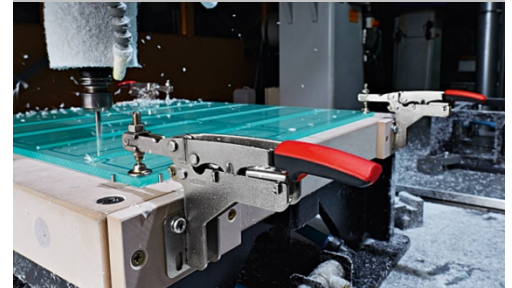
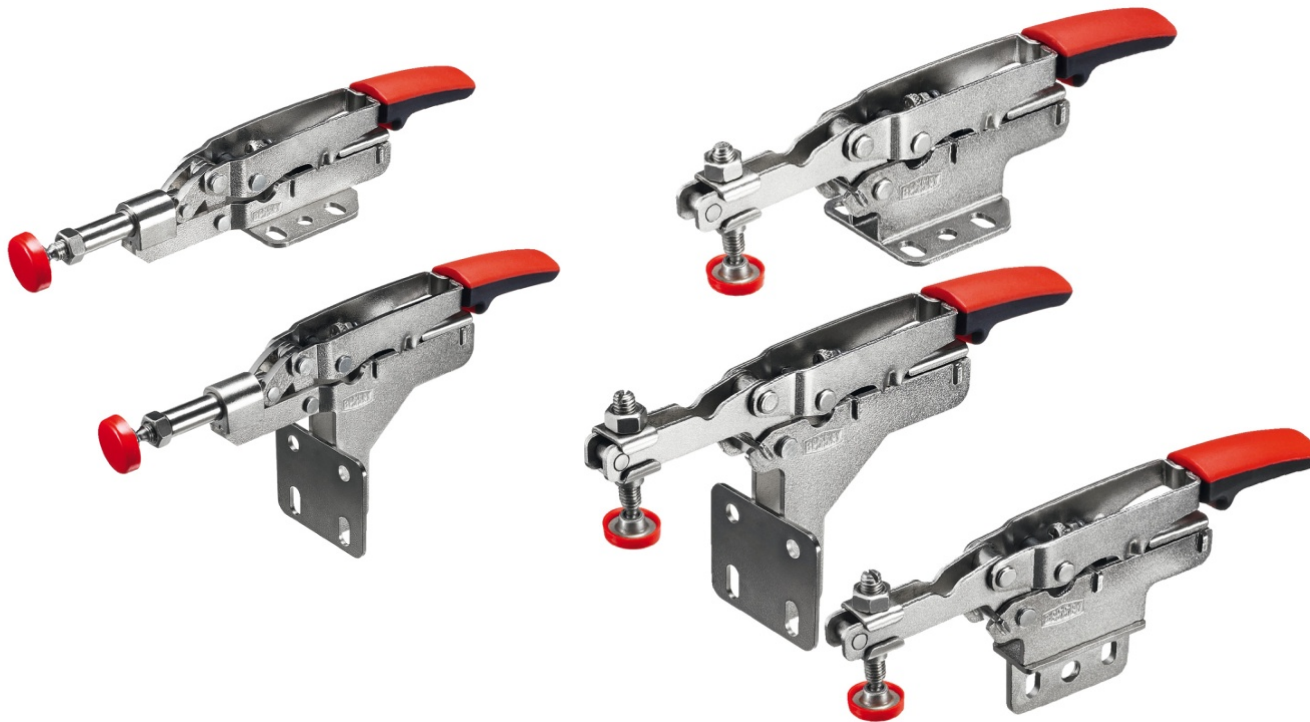

# BESSEY Auto-Adjust Toggle Clamps



- ❑ Three original models were redesigned in 2015
- ❑ BESSEY designs

▶ Horizontal, low profile, STC-HH50



▶ Horizontal, high profile, STC-HH70



▶ InLine, low profile, STC-IHH25

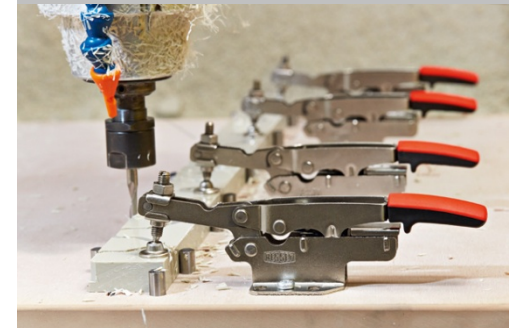
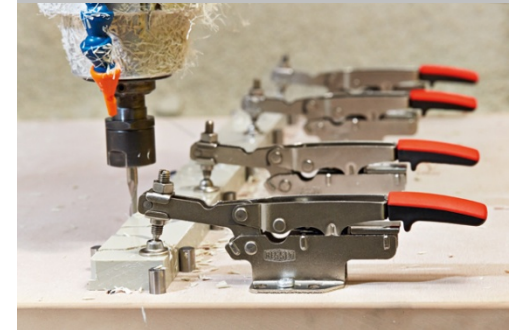
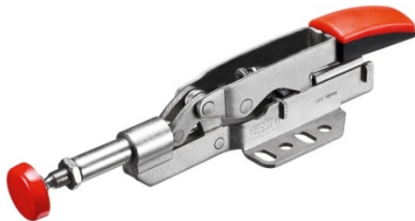



# BESSEY Auto-Adjust Toggle Clamps



- ❑ Two new vertical models added
  - ▶ Vertical, STC-VH20 and STC-VH50

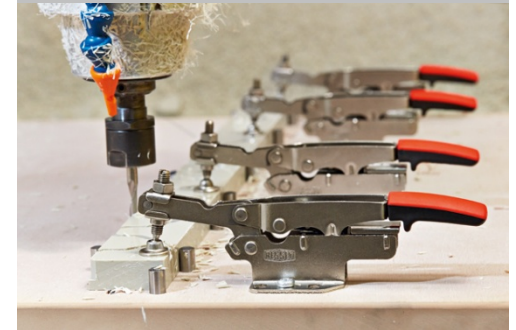

# BESSEY Auto-Adjust Toggle Clamps



## Vertical toggle clamp with open arm and horizontal base plate (STC-VH)

	Opening	Nominal Clamping Force Range	Holding Capacity	Approx. Weight	Fastener
STC-VH20	0- <sup>13</sup> / <sub>16</sub> "	25 - 250 lbs.*	450 lbs.	0.44 lbs.	<sup>3</sup> / <sub>16</sub> " or M5
STC-VH50	0-1 <sup>9</sup> / <sub>16</sub> "	25 - 550 lbs.*	700 lbs.	0.77 lbs.	<sup>1</sup> / <sub>4</sub> " or M6

*STC-VH50 available fall 2014*

## Horizontal toggle clamp with open arm (STC-HH / STC-HV / STC-HA)

with horizontal base plate

	Opening	Nominal Clamping Force Range	Holding Capacity	Approx. Weight	Fastener
STC-HH20	0- <sup>13</sup> / <sub>16</sub> "	25 - 250 lbs.*	450 lbs.	0.44 lbs.	<sup>3</sup> / <sub>16</sub> " or M5
STC-HH50	0-1 <sup>9</sup> / <sub>16</sub> "	25 - 550 lbs.*	700 lbs.	0.77 lbs.	<sup>1</sup> / <sub>4</sub> " or M6
STC-HH70	0-2 <sup>3</sup> / <sub>8</sub> "	25 - 550 lbs.*	700 lbs.	0.86 lbs.	<sup>1</sup> / <sub>4</sub> " or M6

with vertical base plate

STC-HV20	0- <sup>13</sup> / <sub>16</sub> "	25 - 250 lbs.*	450 lbs.	0.55 lbs.	<sup>3</sup> / <sub>16</sub> " or M5
----------	------------------------------------	----------------	----------	-----------	--------------------------------------

with angled base plate

STC-HA20	0- <sup>13</sup> / <sub>16</sub> "	25 - 250 lbs.*	450 lbs.	0.52 lbs.	<sup>3</sup> / <sub>16</sub> " or M5
----------	------------------------------------	----------------	----------	-----------	--------------------------------------

## Push/pull clamp (STC-IHH / STC-IHA)

with horizontal base plate

	Opening	Nominal Clamping Force Range	Holding Capacity	Approx. Weight	Fastener
STC-IHH15	0- <sup>3</sup> / <sub>8</sub> "	25 - 250 lbs.*	450 lbs.	0.52 lbs.	<sup>3</sup> / <sub>16</sub> " or M5
STC-IHH25	0- <sup>5</sup> / <sub>8</sub> "	25 - 550 lbs.*	700 lbs.	0.86 lbs.	<sup>1</sup> / <sub>4</sub> " or M6

with angled base plate

STC-IHA15	0- <sup>3</sup> / <sub>8</sub> "	25 - 250 lbs.*	450 lbs.	0.55 lbs.	<sup>3</sup> / <sub>16</sub> " or M5
-----------	----------------------------------	----------------	----------	-----------	--------------------------------------

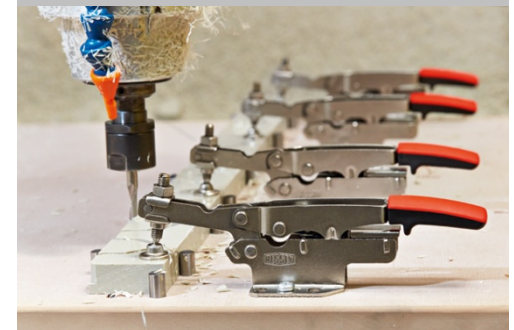
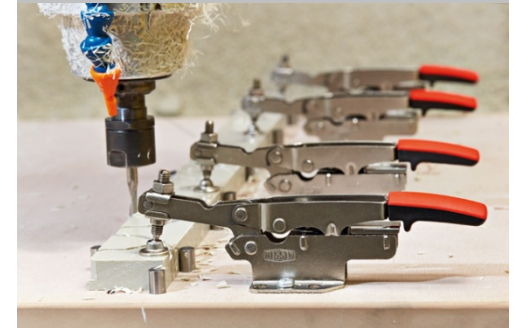

# BESSEY Auto-Adjust Toggle Clamps



## BENEFITS

- ▶ **Safety:** With a clamp that Auto-Adjusts to variations in height you have a much lower chance of being too tight or too loose when a work piece has height variations
- ▶ **Streamline Your Tool Crib:** Fewer but, more flexible, tools
- ▶ **Productivity:** Less “fiddling” with spindle position and neoprene tips
- ▶ **User Comfort:** A large handle for more comfortable clamping
- ▶ **A flexible base:** Different shapes & sizes of holes for easy set up
- ▶ **ONLY from BESSEY:** Only from BESSEY can you get a toggle clamp that can Auto-Adjust within seconds in a wide height range and... with such great clamping force



# BESSEY Auto-Adjust Toggle Clamps



## BENEFITS

- ▶ **Safety:** With a clamp that Auto-Adjusts to variations in height you have a much lower chance of being too tight or too loose when a work piece has height variations
- ▶ **Streamline Your Tool Crib:** Fewer but, more flexible, tools
- ▶ **Productivity:** Less “fiddling” with spindle position and neoprene tips
- ▶ **User Comfort:** A large handle for more comfortable clamping
- ▶ **A flexible base:** Different shapes & sizes of holes for easy set up
- ▶ **ONLY from BESSEY:** Only from BESSEY can you get a toggle clamp that can Auto-Adjust within seconds in a wide height range and... with such great clamping force



# Thank you for your attention!

BESSEY Tools North America